

AĞIR VASITA KATALOĐU
Heavy Vehicle Catalogue

2022

Sektöründe,
müşteri ilişkilerini güven ve
memnuniyet temeli üzerine kurmuş olan SKT,
sızdırmazlık ürünleri konusunda doğru ve güvenilir çözümler
sunmaya devam etmektedir.

Yenilikçi ve mükemmeliyetçi gelecek vizyonu ile sektöründe zirvenin en güçlü
oyuncularından biri olmayı başaran SKT, ürün gamına kattığı ürün çeşitleri iş ortaklarına her
zamanki gibi üstün kalitede ürünler sunmayı amaçlamıştır.

SKT'nin ürün bilgilerine **TECDOC** katalog sisteminden ulaşabilirsiniz.

SKT, 2022 yılında da müşterilerine üstün kaliteye sahip ürünlerini, müşteri memnuniyeti odaklı hizmet, hızlı ve
güvenilir teslimat prensibiyle sunarak yoluna emin adımlarla devam edecektir.

65 yıldır ailemizin bir parçası olan tüm değerli iş ortaklarımıza teşekkür ederiz.

Having established its customer relations based on trust and satisfaction, SKT
continues to offer proper and reliable solutions for sealing products.

With its innovative and perfectionist vision of the future, SKT has managed to become one of the strongest
players in the sector and aims to offer its business partners high-quality products.

SKT is a certified data supplier of TecAlliance.
SKT's product portfolio is available at **TecDoc**.

SKT will continue on its way with firm steps by offering its customers high-quality
products also in 2022 with the principle of customer-oriented services and fast and
reliable deliveries.

We would like to thank all our valuable business partners who have been
a part of our family for 65 years.

AĞIR VASITA KATALOĐU

Heavy Vehicle Catalogue

www.skt.com.tr

BİZİ TAKİP EDİN / Follow us



• sktyagkeceleri



• sktanonimsirketi



• skt yedek parça a.ş.



• skt yağ keçeleri

Bu katalog önceki tüm sayıların yerini almaktadır. Katalog telif hakları ile korunmaktadır. Bunun veya herhangi bir bölümünün çoğaltılması yasaktır.

Bu katalogdaki motor veya araç üreticilerinin tüm orijinal parça numaraları sadece karşılaştırma amacıyla verilmiştir ve araç sahipleri ile temaslarda kullanılmamalıdır. Bu katalogdaki bilgilerin basım anında doğru olması için her türlü çaba gösterilmiştir, ancak SKT herhangi bir sorumluluk kabul edemez. Oluşabilecek hatalar için bileşenlerimizi gerektiği gibi değiştirme hakkımız saklıdır. Orijinal ekipman parça numaraları ve katalogda belirtilen eşdeğer numaralar, yalnızca SKT numaralarıyla çapraz referans karşılaştırması işlevi görür. Herhangi bir tavsiye notunda veya faturada görünmemelidirler.

This catalog replaces all previous editions. The catalog is protected by copyright. Reproduction of this or any part of it is prohibited.

All original part numbers of engine or vehicle manufacturers in this catalog are provided for comparison purposes only and should not be used in contacts with vehicle owners. Every effort has been made to ensure that the information in this catalog is correct at the time of printing, but SKT cannot accept any liability. We reserve the right to change our components as necessary for any errors that may occur. Original equipment part numbers and equivalent numbers listed in the catalog serve only as a cross-reference comparison with SKT numbers. They should not appear on any referral notes or invoices.

Malzeme Bilgileri / Material Information

Tip Açıklamaları / Type Description Page

Tip Tanıtım Sayfaları / Type Description Page

Keçe Tiplerinde Kullanılan Harf Kodlarının Açıklamaları
Explanation Of Letter Codes Used In Seal Types

Keçe Ölçülendirme Sistemi
Seal Dimensioning System

Yağ Keçesi Genel Montaj Kuralları
Oil Seal Installation Guide

Ağır Vasıta Marka Kataloğu / Heavy Vehicle Catalog

BMC

CHRYSLER

DAF

FORD

GÜLERYÜZ

HINO

ISUZU

IVECO

MAN

MERCEDES

MITSUBISHI

OTOKAR

RENAULT

6

SCANIA

91

7

TEMSA

95

8

VOLVO

96

10

Diğer Üretici Markalar / Other Manufacturer Brands

11

CUMMINS

103

DEUTZ

103

12

PERKINS

104

BPW

104

SAF

105

16

FRUEHAUF

105

23

Dorse ve İlave Akslar / Trailers and Axles

106

27

ZF Şanzıman / ZF Gearbox

107

33

MERCEDES Şanzıman / Mercedes Gearbox

116

40

VOITH Retarder

120

40

TELMA Retarder

120

43

EATON

121

46

DANA

121

57

ROCKWELL

122

66

80

FULLER

122

83

MERITOR

122

85

İÇİNDEKİLER

MALZEME BİLGİLERİ / Material Information

Malzeme Adı Material	SKT Kodu SKT Code	Kısa Kodu Abbreviation	Çalışma Sıcaklığı Operating Temp.	AÇIKLAMA	DESCRIPTION
Nitril Kauçuk Nitrile Rubber	-N	NBR	-40 / 105	Genel olarak fiyat / fonksiyon dengesi yüzünden tercih edilen ve düşük sıcaklıklarda kullanılabilen yağ ve greslere dayanıklı genel amaçlı bir keçe malzemesidir. Glikol esaslı fren yağları ve EP katkılı yağlara direnci zayıftır. Yakıtlar ve sanayi sıvıları için özel geliştirilmiş karışımları vardır. Otomotiv sektöründe aks keçelerinde büyük bir kullanıma sahiptir.	It is an economical and general purpose sealing material and preferred due to being resistant against low temperature oil and grease. It has poor resistance to glycol based brake oils and oils with EP additives. There are specially developed mixtures of this material for fuels and industrial fluids. It has a great use in axle seals in the automotive industry.
Hidrojenenitril Kauçuk Hydrogenated Nitrile Rubber	-H	HNBR	-70 / 150	Genel olarak Nitril kauçuk özelliklerini taşır. Nitril kauçuğa ilave olarak esneklik, hava direnci ve ozona dayanım gibi yüksek mekanik özelliklere de sahiptir. Yüksek mekanik dayanım gerektiren direksiyon sistemi ve aks gibi yerlerde kullanım alanı vardır.	This rubber has similar characteristics to nitrile rubber, but it additionally has the mechanical features such as more flexibility, higher weather and ozone- resistance. It is used in applications where high mechanical strength is required such as steering systems, axles and so on.
Florokarbon Kauçuk Fluorocarbon Rubber	-V	FKM	-30 / 220	Sıcaklığın ve yüksek devirin olduğu ortamlarda kullanılan bir kauçuktur. Gres, yakıt, yağ, çözücüler ve kimyasal maddelerin bir çoğuna dayanıklıdır. Fiyat yönünden pahalı bir malzeme olmasına karşın otomotiv sektöründe motor, şanzıman, diferansiyel gibi alanlar ile endüstriyel alanda uzun süre dayanım istenen makinalarda tercih edilir.	This rubber is used in high temperature and high rpm conditions. It is resistant to many types of grease, fuel, oil, solvent and chemicals. Despite being relatively expensive- compared to the other types of rubber materials, this material is employed in fields such as engine, gearbox, differential in automotive industry and also in industrial machines when long-term durability is needed.
Poliakrilik Acrylic Rubber	-P	ACM	-30 / 150	EP katkılı yağlara ve ozona dayanıklı bir malzemedir. Yakıt ve düşük sıcaklık dayanımı zayıf bir malzemedir. Otomotiv sektöründe özellikle şanzıman ve diferansiyel keçelerinde yoğun olarak kullanılır.	This rubber has good resistance to oils with EP additives and ozone. Resistance to fuel and low temperature of this material is somewhat inferior. It is used in gearbox and differential seals in automotive sector.
Silikon Kauçuk Silicone Rubber	-S	VMQ	-60 / 225	Çok iyi bir motor keçesi malzemesidir. Esneklik, hava direnci ve ozona dayanımı yüksektir. Ancak haSS-RLas bir malzeme olduğu için kolayca yırtılabilir, deforme olabilir. Bu nedenle yüksek mekanik dayanım gerektiren ortamlarda ve yakıtlarda EP katkılı yağlarda kullanılması önerilmez.	This rubber is an excellent material for engine seals. In addition to flexibility, its weather and ozone resistance is very high. Yet, it is prone to wear-tear and deformation due to being a very sensitive material. Therefore, it is not recommended in conditions where oils with EP additives are used and high mechanical strength is required.
Etilen Propilen Kauçuk Ethylene-Propylene Rubber	-E	EPDM	-60 / 150	Glikol esaslı fren yağları, ozona, su buharına, fosfat ester akışkanlara direnci iyidir. Yakıtlarda ve petrol esaslı yağlara direnci düşüktür.	This rubber has good resistance to glycol based brake oils, ozone, water vapor, phosphate ester fluids whereas it has low resistance to fuels and petroleum based oils.
Stiren Butadien Kauçuk Styrene-Butadiene Rubber	-R	SBR	-50 / 100	Glikol esaslı fren yağları, asit ve bazlara alkol direnci iyidir. Genel olarak araçların fren sistemlerinde kullanılır. Yakıtlarda ve petrol esaslı yağlara direnci düşüktür.	This rubber has good resistance to glycol based brake oils, acids and bases. It is generally used in brake systems of vehicles. It has low resistance to fuels and petroleum based oils.
Tabii Kauçuk Natural Rubber	-T	NR	-60 / 90	Stiren Butadien kauçuk ile benzer özellikler gösterir. Araçların süspansiyon sistemleri gibi ozona direnç , yüksek esneklik ve mekanik dayanım gerektiren yerlerde kullanılır.	This rubber has similar features to styrene-butadiene rubber. It is used in areas like vehicle suspension systems where ozone resistance, high flexibility and high strength is required.
Politetrafloroetilen Polytetrafluoroethylene	-F	PTFE	-260 / 260	Bilinen tüm kimyasallara dayanıklı bir plastik malzemedir. Sürtünme katsayısı en düşük katı bir maddedir. Yapışma özelliği göstermeyen yağlamasız bir yatak malzemesidir. Uygulama alanına göre dolgu yapısı değiştirebilir. Son yıllarda çok tercih edilen bir motor keçe malzemesidir.	This is a material which is resistant to all known chemicals. It has the lowest coefficient of friction of any solid material. It is a non-adhesive bearing material without lubrication. Filling composition of PTFE may change depending on the field of use. This material is highly preferred in engine seals recently.
Poliamid Polyamide	-C	PA	-20 / 90	Piyasa da "Naylon" olarak bilinir. Sürtünme ve aşınma gibi mekanik özellikleri iyidir. Yağlara, yakıtlara, esterlere, ketonlara karşı dirençlidir.	Also known as nylon, this material has high friction, wear resistance and good mechanical features. It is also resistant to oils, fuels, esters and ketones.
Termoplastik Poliüretan Thermoplastic Polyurethane	-L	TPU	-40 / 90	Özellikle esneklik, aşınma ve sürtünme gibi yüksek mekanik özelliklerine sahip bu malzeme yağlara, greslere ve birçok çözücüye göre de dirençlidir. Kullanım yeri kirliliği ve aşındırıcıların yoğun olduğu ortamlarda kullanılan kombi keçelerin yağ dudaklarını koruyucu malzeme olarak kullanılır. Git-gel harekete sahip ortamlarda da sızdırmazlık malzemesi olarak kullanılır.	In addition to good mechanical features such as high flexibility, high wear and friction durability, this rubber is resistant to oils, greases and many solvents. It is used as a protective material in sealing lips of combi seals which are employed in areas that contains highly dirty and abrasive particles. It is used as sealing material where back and forth axial movement is performed.
Etilen Akriklik Kauçuk Ethylene Acrylic Rubber	-AE	AEM	-30 / 150	Yüksek ısı ve ozon direncine sahip olan AEM kauçuk , motor yağları, şanzıman sıvıları, asidik kondensatlar, üre çözeltileri, soğutucu sıvılar ve gresler gibi sıvılara dayanır. Düşük sıcaklıkta esnekliği, yüksek çekme dayanımı özellikleri ile elektrikli ve hibrit araç bileşenleri dahil olmak üzere zorlu otomotiv uygulamalarında çalışan sızdırmazlık elemanları ve grometlerin üretiminde kullanılır.	AEM rubber which has high heat and ozone resistance, withstands fluids such as engine oils, transmission fluids, acidic condensates, urea solutions, coolants and greases. With its low temperature flexibility, high tensile strength properties, it is used in the manufacture of seals and grommets that work in demanding automotive applications, including electric and hybrid vehicle components.

TİP AÇIKLAMALARI / Type Descriptions

Profil Tipleri / Profile Type			AÇIKLAMA	DESCRIPTION
			Dış çapları kauçuk kaplıdır. Bazı tiplerinde montaj kolaylığı ve yuvadaki deformasyon kaynaklı sızdırmalara karşı dış çaplarında tırtıl vardır. Ayrıca bazı tiplerinde de kirlili ortamlarda koruyuculuk sağlayan toz dudak ilave edilmiştir. Isıl genişleme katsayısı yüksek, parçalı, yüzey pürüzlülüğü yüksek ve eksenli kaçık yuvalarda da kullanılabilirler.	Outer surfaces are rubber coated. Some types also have grooves on the outer layer in order to ease installation process and to act against leakages caused by the deformities in the housing bore. Furthermore, some types have dust lip for preventing dirt ingestion. They can be used in spaces consisting of materials with high coefficient of expansion and in divided spaces with a centre offset.
			Dış çapları metal kaplıdır. Yuvalarına sıkı geçerler. Isıl genişleme katsayıları yüksek metal (alüminyum gibi) yuvalarda ve parçalı yuvalarda kullanılması önerilmez. Bazı tiplerinde kirlili ortamlar için koruyuculuk sağlayan kullanılan toz dudak ilave edilmiştir.	Outer surfaces are metallic. These seals are in interference fitting contact with the housing. Use of these types are not recommended in spaces with high coefficient of expansion (e.g. aluminium) and in divided spaces with a centre offset. Some types also have the secondary dust lip to exclude contaminants.
			Genel olarak L3 ve L1 kombinasyonuna sahip keçe tipleridir. Dış çaptaki sac bölge merkezleme ve sıklığı sağlarken kauçuk bölge ise kauçuk bölüm ise yuvadaki sızdırmazlığı sağlar. Isıl genişlemelerden az etkilenen modern bir dış tasarıma sahiptirler.	In general, these seal types are a combination of types L1 and L3. On the outer diameter, metallic surface helps in centering while rubber surface provides sealing in the housing. They have a modern design that is affected less by thermal expansion.
			L1 keçe tiplerinin tüm özelliklerini taşımalarının yanında büyük çaplarda montaj kolaylığı sağlarlar. Yapısal olarak montaj hatalarına karşı daha dirençlidirler. İç taraftaki bilezik keçeye büyük bir mukavemet sağlarken rulmanlardan gelen yağ jetlerini de karşılayarak keçe dudaklarının sağlıklı çalışmasını sağlarlar.	In addition to all features of type L1, these seals offer ease of assembly in large diameters. They are also quite resistant structurally against assembly errors. Inner ring enhances the structural strength of the seal, while also acts as a shield against oil jets to help sealing lip to function healthily.
			Standart yağ keçeleri 0,5 bar'a kadar çalışabilir. Bu tip keçeler daha yüksek basınçta çalışabilmesi için sac ve dudak profili özel tasarlanmıştır. Bu tip keçelerin verimli çalışabilmesi için ortam şartları, keçenin profili, dudak malzemesi, mil çapı ve devir sayısı önemlidir. Bu keçeler tasarıma da bağlı olarak 5 bar'a kadar çalışabilirler.	Standard oil seals can operate at pressures up to 0,5 bar. Steel case and lip seal profiles of these seals, however, are designed specially in order to obtain the desired resistance against higher pressure values. In order these types of seals to run efficiently ambient conditions, design of the lip seal profile, lip material, shaft diameter and the rpm parameters are significant. Depending on the design, these seals can operate at pressures up to 5 bar.
			Bu tip keçeler genel olarak gres ve yağ buharı ve tozlu ortamlar için kullanılır. Yay kullanılmadığı için sıvı sızdırmazlığına karşı kullanılmazlar. Bazı uygulamalarda mil kazıyıcı olarak da kullanılabilirler.	These types of seals are mainly used for sealing grease, lubricant steam and dust. Since there is no garter spring, they cannot be used for fluid sealing. In some applications, they can be employed as shaft wipers as well.
			Birbirine bağlı olarak çalışan hareketli iki parçadan meydana gelirler. Dış taraf yuvaya, iç taraf ta mile sıkı geçerek çalışırlar ve sızdırmazlık mekanizması iki parça arasında garter yayına sahip sızdırmaz dudak ile kurulmuştur. Standart keçelere göre çok daha yüksek koruyuculuk sağlarlar. Genel olarak yüksek kirlilik ve yük altında çalışan traktör ve ağır vasıtaların akslarında kullanılırlar.	Cassette seals consist of two moving parts that operate in conjunction with each other. Outer ring is in interference fitting contact with the housing and the inner ring with the shaft, while the sealing mechanism is established with main lip with a garter spring in between these rings. Cassette seals are highly rigid and protective and therefore used for very heavy-duty and in dirty environments, like commercial vehicles, tractors and agricultural machinery.
			Kombi keçeler yüksek koruyuculuğa ihtiyaç duyulan aşırı kirlili ve aşındırıcı maddeler bulunan ortamlar için tasarlanmış keçe tipleridir. Genelde çift yaylı bir kauçuk sızdırmaz dudaklar ve aşınmaya dayanıklı plastik bir parça ile kombine çalışırlar. Özellikle aşırı kirlili ortamlarda çalışan traktör aksları ve mekanik dayanım gerektiren direksiyon sistemlerinde kullanılırlar.	Combi seals are designed for extreme wear applications that require high resistance. Generally, two sealing lips with garter spring and an additional wear-resistant plastic part are operating together under the roof of one metal case. They are employed in tractor axles that work under extremely dirty conditions and in steering systems that require mechanical strength.
			Sürtünme katsayısının düşük olması nedeniyle son yıllarda sıkça kullanılan motor keçesi tipleridir. Kullanıldığı motorlara düşük emisyon ve minimum güç kaybı avantajı sağlarlar. Standart keçelere göre dış çapları aynı özellikleri taşırlar ancak sızdırmaz dudaklar mile daha geniş bir noktada temas ederler ve mil kalitesi ve montaj yönünden daha hassasRLas çalışan keçe tipleridir. Bazı tiplerinde toz dudak olarak non-woven malzeme kullanılır.	Due to low coefficient of friction they have, these seals are being used as engine seals more often in the recent years. The advantage of them are low emission and low power loss that they provide. Outer surfaces have the same features, however main sealing lips have bigger contact area in comparison to standard seals. Therefore shaft surface quality and installation accuracy plays a big role in sealing performance. Some types have a dust lip of non-woven material.
			Yeni nesil motorların daha verimli enerji kullanımı ve düşük emisyon değerleri beklenmektedir. Bu ETS tip keçeler düşük sürtünme, uzun ömür ve yüksek performans sağlayan yapısı sayesinde bu motorlarda rahatça kullanılabilir. Yaysız ve mile çok noktadan temas eden bir dudak yapısına sahiptirler. Yeni nesil düşük viskoziteli motor ve şanzıman yağları ile beraber yüksek performansta çalışırlar.	New generation engines are expected to offer more energy efficiency and low emission values. These ETS type seals are great fit for these engines since they provide features such as low friction, long service life and high performance. These seals are spring-less and in contact with the shaft at many points. They operate at high performance with new generation low viscosity engine and transmission oils.

TİP TANITIM SAYFALARI / Type Description Pages



L1

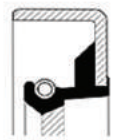

L1 SAĞ

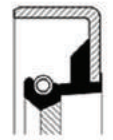

L1 SOL

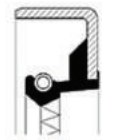

L1 SS



L1B



L1BL

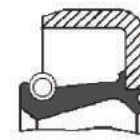

L1CL



L1CL SAĞ

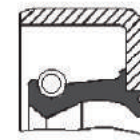

L1L



L1L SAĞ

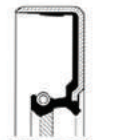

L1L SOL

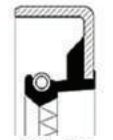

L1L SS

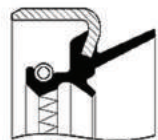

L1LR SS



LL1

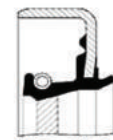

L1R SAG

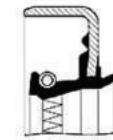

L1R SS

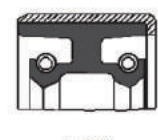

L1X



L2



L2T



L2TR



CL2



L3



L3 SOL



L3 SS



L3 B



L3BL



L3BLL



L3BTL



L3L



L3L SAĞ



L3L SAĞ



L3L SOL



L3L SS



L3LL

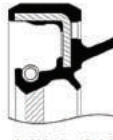

L3LR SAĞ

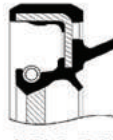

L3LR SOL



L3T



L3T SAĞ



L3T SOL



L3TL



L3TL SAĞ

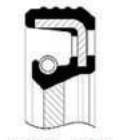

L3TL SOL

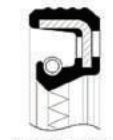

L3TL SS



L3TLL

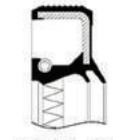

L3TLL SS



L3TLR SAĞ

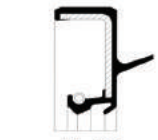

LL3R



LL3T



LL3T SAĞ

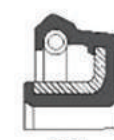

CL3



CLL3

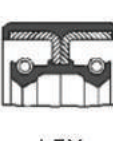

L3X



L4



L5



L5R



L12BL



L12L



L13L

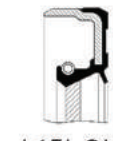

L13L SAĞ

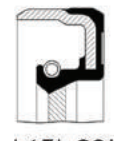

L13L SOL



L13LL SOL

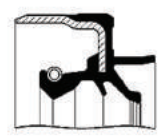

L13LLR

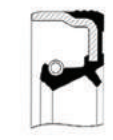

L13TL

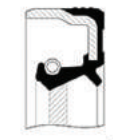

L13TL SAĞ

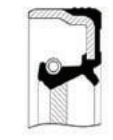

L13TL SOL



L13TL SS



L13TLL SS



L13TLLR SAĞ



L13TLR SAĞ



L13X

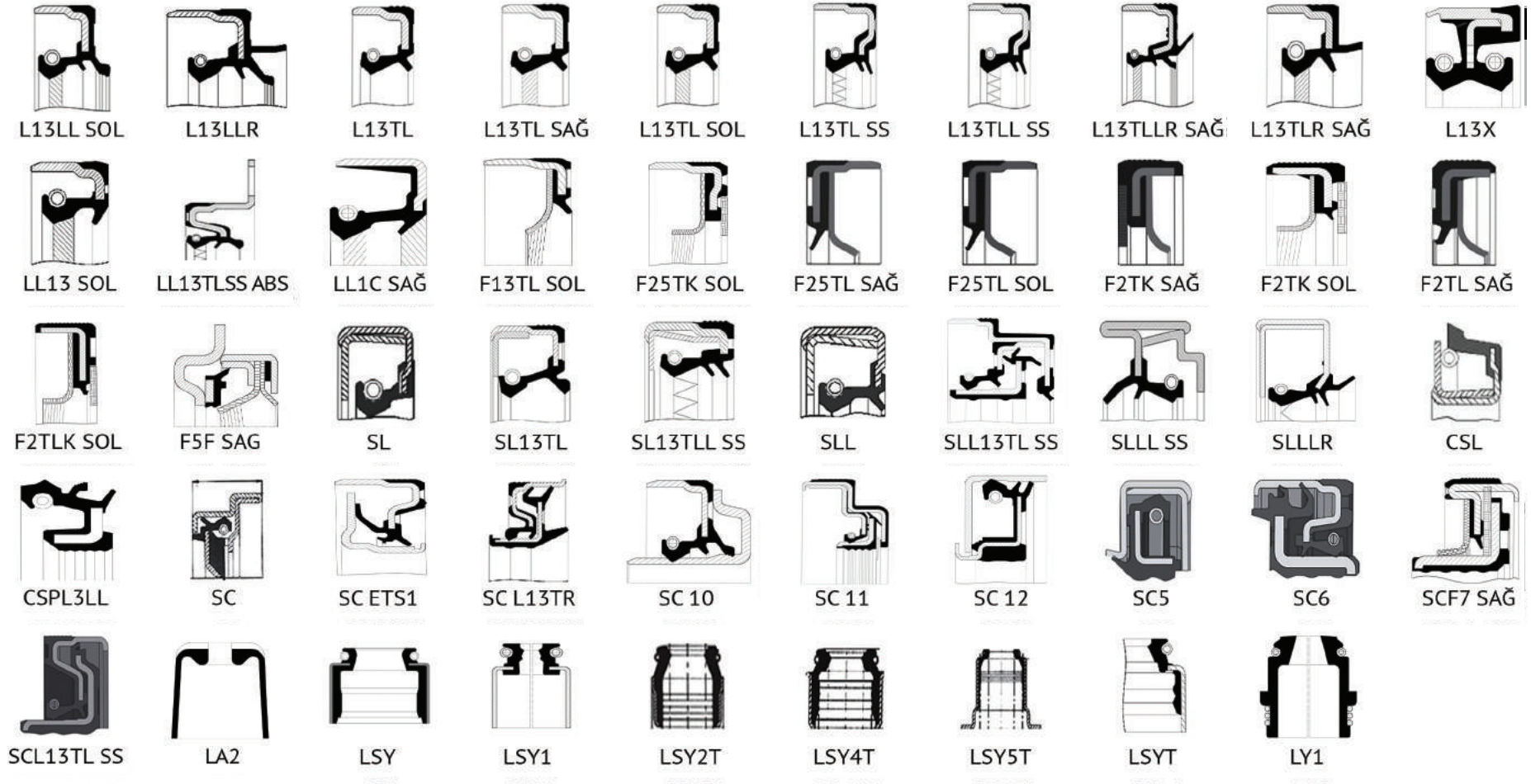

KEÇE DUDAK BÖLGESİNDEKİ TIRTILLARIN AÇIKLAMASI / Terminology For Sealing Aids



SAĞ DÖNÜŞLÜ MİLLER İÇİN
Right-Hand Twist

L3 SAĞ
L3 RIGHT



SOLA DÖNÜŞLÜ MİLLER İÇİN
Left-Hand Twist

L3 SOL
L3 LEFT



SAĞ VE SOLA DÖNÜŞLÜ MİLLER İÇİN
Alternate Twist

L3 SS
L3 RL

KEÇE TİPLERİNDE KULLANILAN HARF KODLARININ AÇIKLAMASI

Explanation Of Letter Codes Used In Seal Types

Sembol / Symbol	Açıklama	Örnek Kullanım / Exemplary Usage	Symbol	Description	Usage example
B	Basınca dayanıklıdır.	L3B	B	Pressure resistant.	L3B
C	Dudak keçe yüksekliğinden daha yüksektir. (1)	L3C	C	Lip height is higher than the seal height.	L3C
C	Keçe dıştan dudaklı ve çevreden çalışmaktadır. (2)	CL3	C	Seal with outside lip, works from periphery.	CL3
ETS	Düşük sürtünmeli (Yaysız) dudak yapısına sahiptir.	SC ETS	ETS	Seal without spring, low friction lip structure.	SC ETS
F	PTFE malzeme kullanılmıştır.	SP F	F	PTFE material is used.	SP F
K	Yün malzeme kullanılmıştır. (Non Woven-NW)	F2TK - NW	K	Wool material is used. (Non Woven-NW)	F2TK
L	Kauçuk malzeme kullanılmıştır.	L1, L3	L	Rubber material is used.	L1, L3
L	Toz dudaklıdır. (3)	L3L, L1L	L	With dust lip.	L3L, L1L
LL	Toz dudağı iki tanedir.	L3LL	LL	With two dust lips.	L3LL
R	Alından çalışan bir dudağa sahiptir.	L3R	R	With sealing lip on the front face.	L3R
T	Keçe dış yüzeyi tırtıllıdır.	L3TL	T	Outer surface grooved.	L3TL
SAĞ	Sağa dönen miller içindir.	L3L SAĞ - L3L RIGHT	RIGHT	For right-hand rotating shafts.	L3L RIGHT
SOL	Sola dönen miller içindir.	L3L SOL - L3L LEFT	LEFT	For left-hand rotating shafts.	L3L LEFT
SS	Her iki yöne de çalışan tırtıl yapısına sahiptir.	L3L SS - L3L RL	RL	For bi-directional shafts.	L3L - RL
SC	Kaset tipi keçedir.	SC1	SC	Cassette type seal.	SC1
SP	Standart tiplerden farklı olup, Özel tip tasarımına sahiptir. (Spesiyal) (4)	SPL3	SP	Special design, different from standard types.	SPL3
X	Çift yay ve çift yağ dudağa sahiptir.	L3X	X	With two lips and two springs.	L3X

(1) : Eğer tip tanımının sonunda ise

(2) : Eğer tip tanımının başında ise

(3) : Başa yazılırsa dudak içe doğru sona yazılırsa dudak dışı doğrudur.

(4) : Profil şekli konusunda dikkatli olunmalıdır.

Özel tasarıma sahip olan keçelerde detaylı bilgi için SKT'ye başvurulmalıdır.

(1) : If it is at the end of type definition

(2) : If it is at the beginning of type definition

(3) : Has an inward lip if it is at the beginning; has an outward lip if it is at the end.

(4) : Profile geometry is to be taken into account carefully.

For detailed information on shaft seals with special design, please consult SKT.

KEÇE ÖLÇÜLENDİRME SİSTEMİ / Seal Dimensioning System

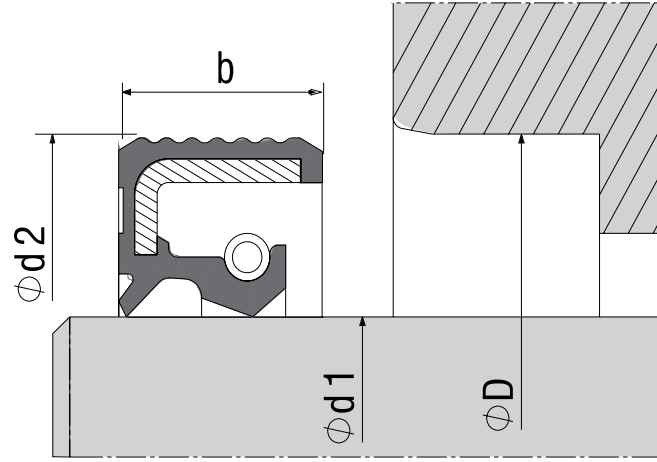

d1	Mil Çapı
D	Yuva Çapı
b	Keçe Yüksekliği
d2	Keçe Dış Çapı
d1	Shaft Diameter
D	Housing Diameter
b	Seal Height
d2	Seal Outer Diameter

Metrik Keçelerin Ölçülendirilmesi Dimensioning of metric seals	d1	x	D	x	b	İnç Ölçülü Keçelerin Ölçülendirilmesi Seal Dimensioning (inches)	d1	x	d2	x	b
		30	x	45	x		8		76,20	x	101,85
	Keçenin çalıştığı mil çapıdır. (Shaft diameter.)		Keçenin çalıştığı yuva çapıdır. (Housing diameter.)		Keçenin toplam yüksekliğidir. (Seal height.)		3"	x	4"	x	15/32"
							Keçenin çalıştığı mil çapıdır. (Shaft diameter.)		Keçenin dış çapıdır. Yuva çapı daha küçük olmalıdır. (Seal outer diameter. Housing diameter has to be smaller.)		Keçenin toplam yüksekliğidir. (Seal height.)

Metrik ölçülü keçelerde D ölçüsü, keçenin çalışacağı yuva çapıdır. Keçe dış çapı bu yuvada yeterli sıklığı sağlayacak şekilde büyük üretilmiştir.

In metric system, dimension "D" is the housing bore diameter. Seal outer diameter is specified accordingly to provide the required interference.

Inch ölçülü keçelerde, d2 ölçüsü keçenin dış çapıdır. Yuva çapı, keçe dış çapından gerekli sıklığı sağlayacak kadar küçük olmalıdır.

In imperial system, dimension "d2" is the seal outer diameter. Housing bore diameter has to be less than seal outer diameter to provide the required interference.

YAĞ KEÇESİ GENEL MONTAJ KURALLARI

A. KAUCUK DUDAKLI KEÇELER

1. Mil ve yuva; ölçüsel tolerans standartlarına uygun - hasarsız ve temiz olmalıdır.
2. Kauçuk malzemeli keçelerin dudakları montajdan önce ortam yağı ile yağlanmalıdır.
3. Keçe montajında uygun bir aparat kullanılmalıdır, kesinlikle çekiç kullanılmamalıdır.
4. Yay boyları kısaltılmamalıdır. Kısaltılırsa; aşırı sürtünmeden dolayı dudak ve mil hızlı bir şekilde aşınır.
5. Keçe dudağındaki sağ-sol helisel dönüş yönüne dikkat edilmelidir.
6. Kaset ve ABS tipli keçeler yapısal olarak çok hassas bir çalışma sistemine sahip olduğu için montaj sırasında keçenin metal kısmı üzerinde hasar bırakacak darbelerden kaçınılmalı ve aparat kullanılmalıdır.
7. Montajdan sonra keçenin salgısı kontrol edilmelidir.
8. Yuva çok bozuk değilse sıvı conta kesinlikle kullanılmamalıdır.

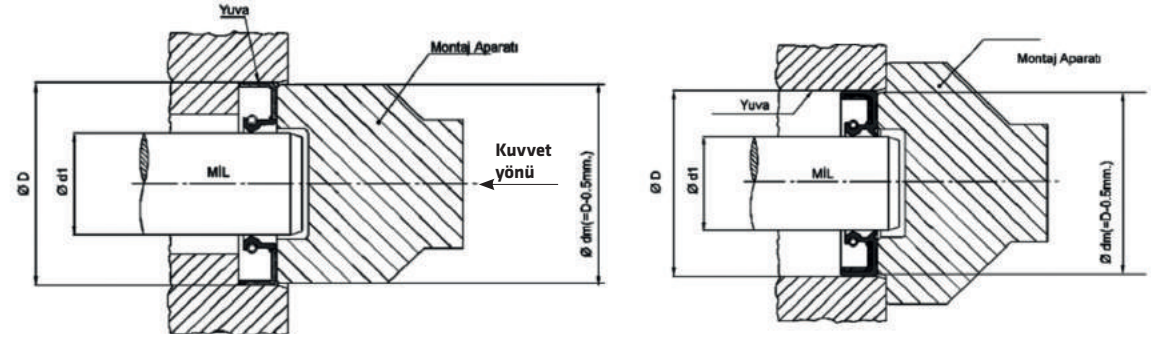

B. PTFE DUDAKLI KEÇELER

1. PTFE malzemeler mekanik olarak dayanımları zayıf olduğundan kesinlikle hasar görmemeli, mil yüzeyi uygun olmalıdır. PTFE dudağa kesinlikle el ile dokunulmamalı, metal bir madde değmemelidir.
2. Uygun bir aparat yardımı ile montaj yapılmalı çekiç kullanılmamalıdır.
3. PTFE keçeler, keçe üzerinde gelen plastik бага ile birlikte yuvaya yerleştirilmeli ve montaj işlemi bitince plastik бага yerinden çıkarılmalıdır.
4. PTFE malzemeli keçelerin dudakları kesinlikle yağlanmamalıdır. PTFE malzemesinin sürtünme katsayısı çok düşük olduğu için kuru çalışabilme özelliğine sahiptir. PTFE keçenin dudakları yağlanır ise ortamda bulunan her türlü aşındırıcıları mil ile dudak arasına toplayacağı için mekanik aşınmadan dolayı keçelerin ömrü kısa olur ve yağ kaçağı oluşabilir.
5. Montaj'dan sonra keçenin ölçüsel değerlerine ulaşabilmesi için motor, en az 4 saat sonra çalıştırılmalıdır. Eğer motor daha erken çalıştırılır ise keçe ölçüsel olarak gerçek boyutlarına ulaşmayacağı için yağ kaçıran.

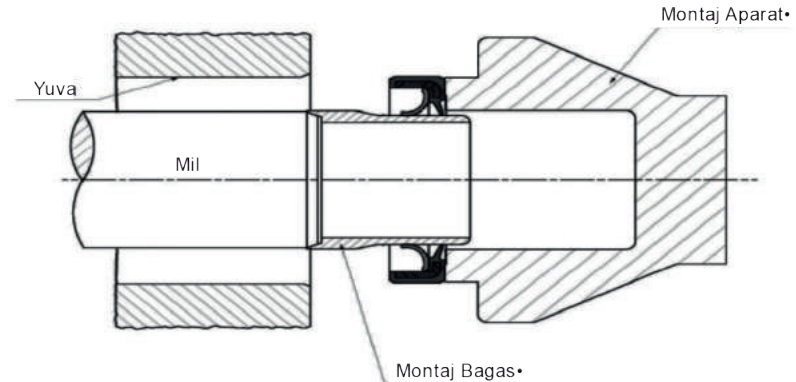

A. ELASTOMERIC LIP SEALS

1. Shaft and housing need to be clean, undamaged and dimensionally appropriate.
2. Elastomeric lip seals are to be lubricated with the ambient oil before installation.
3. A special installation tool is to be employed and never a hammer.
4. Garter springs are never to be shortened. (Shortened springs cause excessive tightness and eventually more wear of shaft and seal.)
5. Direction of the helical ribs on the sealing lip is to be taken into account.
6. When installing cassette and ABS type seals, hammering metal cases is to be avoided in order to prevent damaging blows, since those seals are very sensitive.
7. Seal runout is to be checked after the installation.
8. Gasket sealant is not to be used unless the housing is very defective.

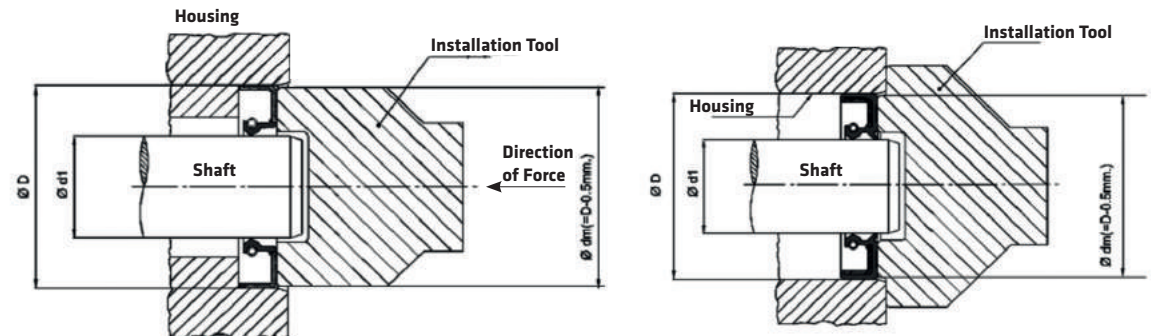

B. PTFE LIP SEALS

1. Due to being weak in terms of mechanical strength, PTFE lip seals are to be kept from any damages and shaft surface is to be superior. PTFE lip is never to be in contact with hand or metal object.
2. A special installation tool is to be employed and never a hammer.
3. PTFE lip seal installation is to be done with the plastic installation sleeve that comes with the product. Installation sleeve is to be removed after the installation.
4. PTFE lips are not to be lubricated. (PTFE material is suitable for dry running due to its very low coefficient of friction. In case of lubrication, majority of the ambient abrasives are drawn into the lubricant in between the lip and the shaft and this could potentially result in wear and eventually leakage.)
5. Do not start the engine sooner than 4 hours after installation. This permits the new sealing lip to adapt perfectly to the shaft.

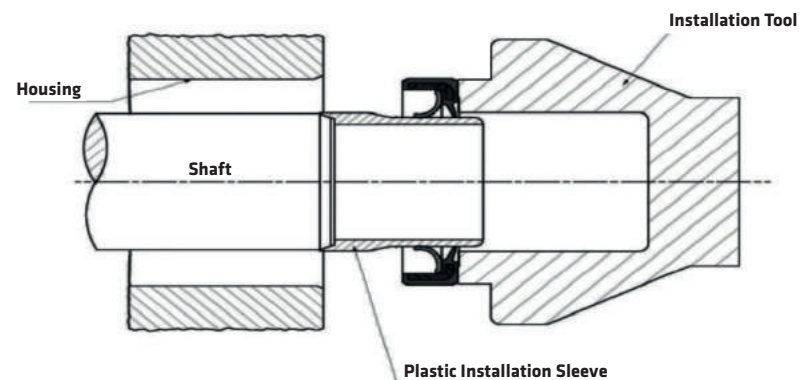

14

**SIZDIRMAZLIK
ELEMENLARINDA
65 YILLIK TECRÜBE**

**65 YEARS
OF EXPERIENCE
IN SEALING ELEMENTS**

**MARKA
MODEL**

Brand
Model

**MOTOR
GRUBU**

Engine
Group

**AKS
GRUBU**

Axle
Group

**DiĐER
ÜRÜNLER**

Other
Parts

**ŞANZIMAN
GRUBU**

Gearbox
Group

**DİREKSİYON
GRUBU**

Steering
Group

**DİFERANSİYEL
GRUBU**

Differential
Group

MOTOR GRUBU / Engine Group

SKT NO	KULLANILAN MODELLER Models	KULLANIM YERİ Place Of Use	ORJİNAL NO 1 Original No 1	ORJİNAL NO 2 Original No 2	EŞDEĞER NO 1 Equivalent No 1	EŞDEĞER NO 2 Equivalent No 2	ÖLÇÜLER - MM. Dimensions - MM.					TİP Type	MALZEME Material
047686-V	4BT-6BT-6BTC MOTOR FATİH-PROF.SERİSİ	KRANK ÖN Crank Shaft Front	3900709	3935959	19036787	15068800	63,50	79,58	79,75	7,93		L13TL SAĞ -Right	FKM
047834-FH	6BT MOTOR FATİH-PROF.SERİSİ	KRANK ÖN Crank Shaft Front	9P909649	3935960	19036787	15068800	63,50	79,58		7,93		F5F SAĞ -Right	PTFE+HNBR
047687-V	6CT-6CTA MOTOR FATİH-PROF.SERİSİ	KRANK ÖN Crank Shaft Front	3921927	4025270	49359771	15073500	75,01	93,07	93,42	11,51		L13TL SAĞ -Right	FKM
047833-FS	6CT MOTOR FATİH-PROF.SERİSİ	KRANK ÖN Crank Shaft Front	9P912300	4025271	49359771	15073500	75,01	93,07		11,51		F5F SAĞ -Right	PTFE+VMQ
412128-S	1340 G-TM140-TM150	KRANK ARKA Crank Shaft Rear	13H3316	13H3009	15042400	NA933	127,00	146,30		11,11		L3 SOL-Left	VMQ
412253-S	YAVUZ 1850-2200	KRANK ARKA Crank Shaft Rear	471056	4710562	12013863	-	127,00	150,00		11,50		L3 SOL-Left	VMQ
412291-V	CUMMINS BT-CT SERİSİ FATİH-PROF.SERİSİ	KRANK ARKA Crank Shaft Rear	3925529	3933262	19036879	15068900	130,18	150,25	150,47	14,28		L13TL SOL -Left	FKM
412347-FP	6BT-6CT MOT.FATİH-PROF.- (YAYSIZ-TEFLON)	KRANK ARKA Crank Shaft Rear	3904353	3933262	19036879	15068900	130,18	150,25	150,47	14,28		F13TL SOL -Left	PTFE+ACM
045424-S	1340 G-TM140-TM150	EKSANTRİK MİLİ Cam Shaft	83H917	-	-	-	55,56	73,27		11,50	12,70	L3L SAĞ -Right	VMQ
045214	OTOBÜS GRUBU	FAN KASNAĞI Fan Pulley	2B70448	-	12010909	-	35,00	55,00	-	10,00	-	L3	NBR
045938-P	220-17 OTOBÜS GRUBU	ŞARJ DİNAMOSU Charge System	9P908713	-	-	-	42,00	56,00	-	7,00	-	L3L SS-RL	ACM
4S-043-V	FATİH-PROF.SERİSİ 6BT MOT.	SUPAP Valve Stem Seal	9P917760	-	-	-	7,35	13,50	33,90	18,20	23,80	LSY5T	FKM
4S-044-V	FATİH-PROF.SERİSİ 6CT MOT.	SUPAP Valve Stem Seal	9P900103	-	-	-	9,00	15,70	22,10	9,10	14,09	LSY5T	FKM
4CN-063-V	6BT-6CT MOT. FATİH-PROF.SERİSİ	SİLİNDİR GÖMLEK LAST. Cylinder Liner	3907177	-	-	-	118,00	122,32		4,00		MH	FKM
040504	FATİH 220	RADYATÖR SİSTEMİ Radiator System	2B72749	50449205	12010853	-	25,00	42,00		6,00		L3	NBR

AKS GRUBU / Axle Group

SKT NO	KULLANILAN MODELLER Models	KULLANIM YERİ Place Of Use	ORJİNAL NO 1 Original No 1	ORJİNAL NO 2 Original No 2	EŞDEĞER NO 1 Equivalent No 1	EŞDEĞER NO 2 Equivalent No 2	ÖLÇÜLER - MM. Dimensions - MM.					TİP Type	MALZEME Material
047424	PROF. 518-522	ÖN AKS Front Axle	57RS300035		-	-	69,85	92,15		11,90		SLL	NBR
410320	FATİH 105-110	ÖN AKS Front Axle	7K16038	4K14681	12014743	000.745	72,00	105,00		13,00		SL	NBR
410320-V	FATİH 105-110	ÖN AKS Front Axle	7K16038	4K14681	12014743	000.745	72,00	105,00		13,00		SL	FKM
410158	1340 G-TM140-TM150	ÖN AKS Front Axle	AMK4386	-	19034440	-	87,31	114,55		12,70		L3	NBR
412350-V	PROF. SERİSİ	ÖN AKS Front Axle	57RS308255	-	-	-	89,95	129,00		12,00		L3X	FKM
412351-V	PROF. SERİSİ	ÖN AKS Front Axle	57RS308256	-	-	-	98,40	137,00		12,00		L3X	FKM
412286	FATİH-PROF.SERİSİ TÜM MODELLER	ÖN AKS Front Axle	7K52983	-	-	-	101,60	139,85		12,70		SL	NBR
412304	FATİH-YAVUZ-PROF.SERİSİ TÜM MODELLER	ÖN AKS Front Axle	7K52983	-	-	-	101,60	139,85	140,15	12,70		L13TL SS-RL	NBR
412172	FATİH SERİSİ -YAVUZ SERİSİ	ÖN AKS Front Axle	7K203061	-	-	-	101,60	139,85		14,28		SL	NBR
412345-V	FATİH-PROF. SERİSİ	ÖN AKS Front Axle	57RS307894	-	-	-	115,00	140,00		13,00		L1L	FKM
040875	FATİH - PROF. SERİSİ	ÖN AKS KİNG PİMİ Front Axle King Pin	57RS300389	-	-	-	38,10	44,58		4,76		L5	NBR
046116	FATİH-PROF SERİSİ	ÖN AKS KİNG PİMİ Front Axle King Pin	57RS307896	-	-	-	50,00	58,18		4,50		L5R	NBR
046084-VP	FATİH-PROF. SERİSİ (9 TON DİNGİL)	ARKA AKS Rear Axle Outer	57RS304499	-	-	-	50,00	65,00		14,00		SPL13TLL SS-RL	FKM+ACM
412263-V	FATİH 105-110 KAMYON	ARKA AKS Rear Axle	4K14453	-	-	-	86,00	127,00	112,00	12,00	21,00	SPLSL	FKM
412119	TM 140-150	ARKA AKS Rear Axle	-	-	-	-	107,95	143,02	-	12,70	-	SL	NBR
412285	PROF. 522 SERİSİ	ARKA AKS Rear Axle	57RS305183	-	12016441	457.710	120,00	150,00		15,00		L13TL SS-RL	NBR
412159	FATİH 280-PROF 935	ARKA AKS Rear Axle	4K97190	-	-	-	125,00	150,00		13,00		L1L	NBR
412159-V	FATİH 280-PROF 935	ARKA AKS Rear Axle	4K97190	-	-	-	125,00	150,00		13,00		L1L	FKM

AKS GRUBU / Axle Group

SKT NO	KULLANILAN MODELLER Models	KULLANIM YERİ Place Of Use	ORJİNAL NO 1 Original No 1	ORJİNAL NO 2 Original No 2	EŞDEĞER NO 1 Equivalent No 1	EŞDEĞER NO 2 Equivalent No 2	ÖLÇÜLER - MM. Dimensions - MM.					TİP Type	MALZEME Material
415153-V	FATİH-PROF.SERİSİ	ARKA AKS Rear Axle	57RS308726	-	-	-	125,00	155,00		14,00		L3L	FKM
415172-V	FATİH-PROF.SERİSİ (9 TON DİNGİL)	ARKA AKS Rear Axle	57RS307734	-	01016689	826.774	145,00	175,00		16,00		L13TLL SS-RL	FKM
417076	FATİH-PROF.SERİSİ TÜM MODELLER	ARKA AKS Rear Axle	7K10942	-	-	-	165,10	197,05		15,87		SL	NBR
417101	FATİH-PROF.SERİSİ TÜM MODELLER	ARKA AKS Rear Axle	57RS300414	-	-	-	165,10	197,05		15,87		L13TL SS-RL	NBR
417101-V	FATİH-PROF.SERİSİ TÜM MODELLER	ARKA AKS Rear Axle	57RS304252	-	-	-	165,10	197,05		15,87		L13TL	FKM
4KIT-065	FATİH-PROF.SERİSİ TÜM MODELLER	ARKA AKS Rear Axle	4K97316	-	-	-	-	-	-	-	-	KIT	-
4D-291-P	FATİH-PROF.SERİSİ TÜM MODELLER	ARKA AKS Rear Axle	KOC2048	4K86072	-	-	72,00	96,00		23,00		LS	ACM
420060	FATİH-PROF.SERİSİ TÜM MODELLER	ARKA AKS Rear Axle	57RS304253	57RS302781	-	-	92,08	215,30	15,00	190,30	10,50	SPL1L	NBR
420060-V	FATİH-PROF.SERİSİ TÜM MODELLER	ARKA AKS Rear Axle	57RS304253	-	-	-	92,08	215,30	15,00	190,30	10,50	SPL1L	FKM
410338	FATİH 105-110 1992 =>	ARKA AKS DIŞ Rear Axle Outer	4K14681	-	-	-	56,00	112,00		8,00	10,00	SPL2	NBR
410337	FATİH 105-110 1992 =>	ARKA AKS DIŞ Rear Axle Outer	4K14681	-	-	-	58,00	112,00		8,00	10,00	SPL2	NBR
415052	FATİH-YAVUZ-PROF.SERİSİ TÜM MODELLER	ARKA AKS (İLAVE DİNGİL) Rear Axle	21K7828	-	-	-	128,59	155,83		12,70		L3	NBR
040900-Z	FATİH - PROF. SERİSİ	FREN MİLİ Brake Shaft	68200114	815139	19031974	-	38,10	47,70		4,70	5,60	L1L	NBR
040429	FATİH - PROF. SERİSİ	FREN MİLİ Brake Shaft	5K17647	-	-	-	38,10	47,70		4,76		L5	NBR
047219	ASKERİ ARAÇ-BTR	ARKA AKS FREN TABLASI Rear Axle Brake Pad	4B77015	-	12011009	-	65,00	90,00	-	10,00	-	L3	NBR
4D-406-S	FATİH-PROF.SERİSİ (ROCKWELL 410)	FREN MİLİ Brake Pad Dust Seal	1205X2000	42531677	-	-	14,70	42,90		53,00	28,00	D	VMQ
4D-270-S	FATİH-PROF. SERİSİ	FREN MİLİ Brake Pad Dust Seal	RBS107	-	-	-	14,70	53,00		17,00		LS	VMQ
4D-271-S	FATİH-PROF. SERİSİ	FREN MİLİ Brake Pad Dust Seal	RBS104	-	-	-	14,70	53,00		28,00		LS	VMQ

AKS GRUBU / Axle Group

SKT NO	KULLANILAN MODELLER Models	KULLANIM YERİ Place Of Use	ORJİNAL NO 1 Original No 1	ORJİNAL NO 2 Original No 2	EŞDEĞER NO 1 Equivalent No 1	EŞDEĞER NO 2 Equivalent No 2	ÖLÇÜLER - MM. Dimensions - MM.				TİP Type	MALZEME Material	
4D-410-S	FATİH-PROF.SERİSİ (ROCKWELL 410)	FREN MİLİ Brake Pad Dust Seal	1205E2683	42537841	-	-	25,00	47,85		11,70		LS	VMQ
4D-311-S	FATİH-PROF.SERİSİ TÜM MODELLER	FREN Z-KAM MİLİ Brake Z Shaft	68191589	-	-	-	35,20	68,30		16,20		LS	VMQ
4D-345-S	FATİH-PROF.SERİSİ TÜM MODELLER	FREN Z-KAM MİLİ Brake Z Shaft	9P901358A	-	-	-	35,75	68,30		19,85		LS	VMQ

DİFERANSİYEL GRUBU / Differential Group

SKT NO	KULLANILAN MODELLER Models	KULLANIM YERİ Place Of Use	ORJİNAL NO 1 Original No 1	ORJİNAL NO 2 Original No 2	EŞDEĞER NO 1 Equivalent No 1	EŞDEĞER NO 2 Equivalent No 2	ÖLÇÜLER - MM. Dimensions - MM.				TİP Type	MALZEME Material	
045514	1340 G-TM140-TM150/YAVUZ 1850-2200	MAHRUTİ (DİFER.ÖN) Differential - Front	ZZL1121	7H6519	-	-	38,10	51,00		5,55		L3	NBR
410442-PN	PROBÜS	MAHRUTİ (DİFER.ÖN) Differential - Front	9P909200	7149488	12006485	-	63,50	98,45	108,00	15,00	17,90	SC	ACM+NBR
410288-P	YAVUZ-TM-FATİH ESKİ MODEL	MAHRUTİ (DİFER.ÖN) Differential - Front	81673	-	-	-	66,67	103,34	112,69	12,70	27,78	SPL1L	ACM
410325-NK	YAVUZ-1850-2200	MAHRUTİ (DİFER.ÖN) Differential - Front	81673	-	-	-	66,67	103,34	112,69	12,70	27,78	SPL1K SS-RL	NBR+YÜN- NW
410267-V	FATİH 162-170-200 18000 SERİ DİF.	MAHRUTİ (DİFER.ÖN) Differential - Front	4K98415	-	01016915	-	66,67	116,02	125,40	11,90	19,25	SPL1L SS-RL	FKM
410120-NK	FATİH 162-170-200 18000 SERİ DİF. YÜNLÜ	MAHRUTİ (DİFER.ÖN) Differential - Front	190578	-	-	-	66,67	116,03		12,70	22,22	SPL1K	NBR+YÜN- NW
412289-V	FATİH 200-26 (EATON 23000 SERİ DİFR.)	MAHRUTİ (DİFER.ÖN) Differential - Front	210724	-	01020451	-	74,60	128,00	143,00	12,50	27,50	SPL11LR SS-RL	FKM
412273-V	FATİH SERİSİ 23000 SERİ DİF.	MAHRUTİ (DİFER.ÖN) Differential - Front	119432	-	19037022	-	74,61	125,58	136,52	12,70	31,75	SPL1LL SS-RL	FKM
410364-V	FATİH-PROF.SERİSİ- 22000 SERİSİ DİFR.	MAHRUTİ (DİFER.ÖN) Differential - Front	-	-	12013643	UH0327E	76,20	114,43	120,65	10,90	19,05	SPL1LLR SS-RL	FKM
410239-V	FATİH SERİSİ -YAVUZ SERİSİ-PROF. 617-620	MAHRUTİ (DİFER.ÖN) Differential - Front	4K97141	-	-	-	80,00	105,00		13,00		L1L	FKM
412352-VP	PROF. 827 SERİSİ (ROCKWELL DİFR.)	MAHRUTİ (DİFER.ÖN) Differential - Front	9P920308	-	-	-	82,00	140,00	149,00	18,00	21,50	SC	FKM+ACM
415161-VN	FATİH-PROF. SERİSİ	MAHRUTİ (DİFER.ÖN) Differential - Front	57RS304758	42531764	12006479	457.270	82,55	139,95	152,40	16,35	19,05	SPL3LL4 SS-RL	FKM+NBR

DİFERANSİYEL GRUBU / Differential Group

SKT NO	KULLANILAN MODELLER Models	KULLANIM YERİ Place Of Use	ORJİNAL NO 1 Original No 1	ORJİNAL NO 2 Original No 2	EŞDEĞER NO 1 Equivalent No 1	EŞDEĞER NO 2 Equivalent No 2	ÖLÇÜLER - MM. Dimensions - MM.				TİP Type	MALZEME Material	
412336-V	PROF.822-827-832	MAHRUTİ (DİFER.ÖN) Differential - Front	57RS305778	-	-	-	110,00	130,00		12,00		L1L SS-RL	FKM
412189-V	PROF.822 6X4	MAHRUTİ (DİFER.ARKA) Differential - Rear	4K97712	-	-	-	110,00	130,00	-	13,00	-	L1L SOL-Left	FKM
040591	FATİH 280	DİF.TAKVİYE SİST. Differential Shaft	4K97183	25145	12011111	-	16,00	28,00		7,00		L3L	NBR
047819-V	PROF. 827	DİF.TAKVİYE SİST. Differential Shaft	4K97736	-	-	-	65,00	85,00		13,00	8,50	L13L	FKM

ŞANZİMAN GRUBU / Gearbox Group

SKT NO	KULLANILAN MODELLER Models	KULLANIM YERİ Place Of Use	ORJİNAL NO 1 Original No 1	ORJİNAL NO 2 Original No 2	EŞDEĞER NO 1 Equivalent No 1	EŞDEĞER NO 2 Equivalent No 2	ÖLÇÜLER - MM. Dimensions - MM.				TİP Type	MALZEME Material	
045606-P	1340 G/TM140-150/YAVUZ-570 HEMA TİP ŞANZ.	ŞANZİMAN ÖN Gearbox Front	X10889	37H4667	-	-	39,69	60,50		9,52		L3	ACM
046132-P	PROBÜS 215-F180	ŞANZİMAN ÖN Gearbox Front	9P909073	7910247576	12013896	040.363	42,00	62,00		10,00		L3TL SAĞ -Right	ACM
045763-P	FATİH 162-170-200 / YAVUZ- HEMA 570 ŞANZ.	ŞANZİMAN ÖN Gearbox Front	CKE66957	900576	-	-	44,45	62,10		9,52		L3	ACM
045827-V	FATİH 214-220-270 / PROF SERİ. ZF 9S75-109-16S 109	ŞANZİMAN ÖN Gearbox Front	0750111149	9P900991	20016209	586.676	48,00	65,00		10,00		L13TL SAĞ -Right	FKM
046011	FATİH 214-220-270 ZF 9S75 - 9S109	ŞANZİMAN ÖN Gearbox Front	0501311146	-	01017792	-	60,00	74,80		4,70		SPL5	NBR
045589	1340 G 1981 6/98-	ŞANZİMAN ARKA Gearbox Rear	37H5892	195474-M1	-	-	50,80	70,10		12,70		L3	NBR
047554-P	FATİH 105-110	ŞANZİMAN ARKA Gearbox Rear	X13072	-	-	-	53,98	76,40		9,52		L3L SOL-Left	ACM
047647-V	200-26 FATİH SERİSİ - EATON 4106 ŞANZ.	ŞANZİMAN ARKA Gearbox Rear	9P901616A	X13711	12014424	-	65,00	85,00		13,00	9,50	L13L SOL -Left	FKM
047598-P	FATİH 162-170-200 (TURNER ŞANZ.)	ŞANZİMAN ARKA Gearbox Rear	CKC66960	-	-	-	66,67	85,75		11,11	14,28	L1L SOL-Left	ACM
047243	YAVUZ 1850-2200	ŞANZİMAN ARKA Gearbox Rear	CKC61970	-	-	-	66,67	85,92		9,52		L3	NBR

ŞANZIMAN GRUBU / Gearbox Group

SKT NO	KULLANILAN MODELLER Models	KULLANIM YERİ Place Of Use	ORJİNAL NO 1 Original No 1	ORJİNAL NO 2 Original No 2	EŞDEĞER NO 1 Equivalent No 1	EŞDEĞER NO 2 Equivalent No 2	ÖLÇÜLER - MM. Dimensions - MM.					TİP Type	MALZEME Material
047563-P	FATİH 162-170-200 / YAVUZ SERİSİ	ŞANZIMAN ARKA Gearbox Rear	X13702	X13004	-	-	66,67	95,50		11,90		L3L SOL-Left	ACM
047843-V	PROBÜS 215-F180	ŞANZIMAN ARKA Gearbox Rear	9P914123	702607235	12014736	348.856	70,00	90,00		10,00		L3T SOL-Left	FKM
047645-V	FATİH SERİSİ EATON 8209	ŞANZIMAN ARKA Gearbox Rear	9P907813A	-	12013860	034.347	78,00	100,00		10,00		L13TL SOL -Left	FKM
047650-V	FATİH 214-220-270 / PROF.SERİSİ ZF 9S75-109	ŞANZIMAN ARKA Gearbox Rear	0750111334	9P900748	12013361	587.966	80,00	100,00		8,00		L3TL SOL -Left	FKM
047711-V	FATİH 214-220-270 / PROF.SERİSİ ZF 9S75-109	ŞANZIMAN ARKA Gearbox Rear	0750111334	9P900748	12013361	587.966	80,00	100,00		10,00		L3TL SOL -Left	FKM
410341-V	FATİH 214-220-240 / PROF.SERİSİ-EATON 8209	ŞANZIMAN ARKA Gearbox Rear	X8875615	12152257	12012579	902.994	90,00	110,00		12,00		L13TL SOL -Left	FKM
410435-V	PROF. SERİSİ (ZF ŞANZ.)	ŞANZIMAN ARKA Gearbox Rear	7981666	-	20034608	-	90,00	125,00		12,00		L13TL SOL -Left	FKM
410403-V	PROF.SERİSİ ZF 9S109-16S109	ŞANZIMAN ARKA Gearbox Rear	9P909476A	1297604	01026691	-	105,00	125,00		12,00	9,50	L13TL SOL -Left	FKM
412344-V	FATİH-PROF. SERİSİ	ŞANZIMAN ARKA Gearbox Rear	9P913652A	0734319253	01018282	314.994	105,00	130,00		12,00		L13TL SOL -Left	FKM
047830-P	TÜM MODELLER ZF 16S 151-181	ŞANZIMAN YARDIMCI MİLİ Gearbox Auxiliary Shaft	0501314060	1240023	01017789	-	77,00	95,30		6,00		L5	ACM
040776	PROF. 617-620-822-827-832	ŞANZIMAN MİLİ Gearbox Axle	4K88155	-	-	-	11,00	18,00	18,80	3,00	5,00	SPL5	NBR
040774-V	CARGO 2621 ZF 9S75	ŞANZIMAN KLM.ÇIKIŞ MİLİ Speedometer Shaft	0634300185	06344300105	01002259	010.804	10,00	15,00		3,00		L5	FKM
040745	FATİH-PROF SERİSİ ZF 9S75	ŞANZ. DEBRİYAJ KEÇESİ Clutch Shaft Seal	9P900646	1456528	12011122	038.075	25,00	35,00		7,00		L3TL	NBR
041177	FATİH 214-220-270 / PROF.SERİLERİ ZF 9S75-109	ŞANZ. DEBRİYAJ KEÇESİ Clutch Shaft Seal	9P900646	0634300302	12014616	038.083	25,00	35,00		7,00		L13TL	NBR
4FM-112-CA	FATİH-PROF.SERİSİ EATON 8209 ŞANZ.	ŞANZIMAN YAĞ BORUSU Gearbox Oil Pipe	X8875532	-	-	-	65,00	70,00		2,10		L KARE	PTFE
041110-V	PROF.FATİH SERİSİ ZF 9S109-16S109	ŞANZIMAN KULESİ Gearbox Tower	9P900726A	0750112047	01029805	-	22,00	36,00	48,00	14,50		SPL3CTL	FKM
041111-V	FATİH-PROF. SERİSİ ZF 9S75 ŞANZ.	ŞANZIMAN KULESİ Gearbox Tower	0501316333	-	01032393	-	22,00	36,00	57,00	14,50		SPL3CTL	FKM
041106-V	PROF. SERİSİ	ŞANZIMAN KULESİ Gearbox Tower	9P924297A	0750112131	01029609	733.480	25,00	40,00	49,00	15,00		SPL13CTL	FKM

ŞANZİMAN GRUBU / Gearbox Group

SKT NO	KULLANILAN MODELLER Models	KULLANIM YERİ Place Of Use	ORJİNAL NO 1 Original No 1	ORJİNAL NO 2 Original No 2	EŞDEĞER NO 1 Equivalent No 1	EŞDEĞER NO 2 Equivalent No 2	ÖLÇÜLER - MM. Dimensions - MM.				TİP Type	MALZEME Material	
4P-262-V	PROF.-FATİH SERİSİ	ŞANZİMAN PİSTON KEÇESİ Gearbox U Packing Seal	0750112089	-	504.540	5045400	53,00	63,00		16,20		PCX4	FKM
4P-260-H	ZF 9S75 ŞANZ.	TAKVİYE PİSTON KEÇESİ Reinforcement Piston Seal	0734309378	-	12014456	-	63,00	16,00		10,50		LS	HNBR

DİREKSİYON GRUBU / Steering Group

SKT NO	KULLANILAN MODELLER Models	KULLANIM YERİ Place Of Use	ORJİNAL NO 1 Original No 1	ORJİNAL NO 2 Original No 2	EŞDEĞER NO 1 Equivalent No 1	EŞDEĞER NO 2 Equivalent No 2	ÖLÇÜLER - MM. Dimensions - MM.				TİP Type	MALZEME Material	
040743	FATİH 162-170-200 / PROF.617-620/ZF8043-8046	DİREKSİYON KUTUSU Steering Box	0770198103	42488743	12014826	006.408	26,00	37,00		7,00	8,00	L3BTL	NBR
040929	PROF. SERİSİ	DİREKSİYON KUTUSU Steering Box	0770080252	0770198134	01020066	-	26,00	34,00		4,50	7,00	SPL3BL	NBR

MOTOR GRUBU / Engine Group

SKT NO	KULLANILAN MODELLER Models	KULLANIM YERİ Place Of Use	ORJİNAL NO 1 Original No 1	ORJİNAL NO 2 Original No 2	EŞDEĞER NO 1 Equivalent No 1	EŞDEĞER NO 2 Equivalent No 2	ÖLÇÜLER - MM. Dimensions - MM.					TİP Type	MALZEME Material
047330-S	PD 600-700-800-900-950 6.354 PERKİNS MOT.	KRANK ÖN Crank Shaft Front	2236124	-	-	-	60,33	79,47		11,22	13,89	SPSL	VMQ
047894-V	PD 600-700-800-900-950 6.354 PERKİNS MOT.	KRANK ÖN Crank Shaft Front	2418F437	-	12014981	587.010	60,33	79,62		9,33	11,23	L3TL SAĞ -Right	FKM
047558-V	PD 600-700-800-900-950 6.354 PERKİNS MOT.	KRANK ÖN Crank Shaft Front	2418F436	2415361	12014981	587.010	60,33	79,62		9,52	11,11	L3L SAĞ -Right	FKM
415171-V	PD 600-700-800-900-950 6.354 PERKİNS MOT.	KRANK ARKA Crank Shaft Rear	2418F475	1800T	12010753	587.842	133,35	158,94	159,16	11,11	11,13	L13TL SOL -Left	FKM
415137-V	PD 600-700-800-900-950 6.354 PERKİNS MOT.	KRANK ARKA Crank Shaft Rear	2418F475	1800T	12010753	587.842	133,35	159,05		11,11	13,00	L3L SOL-Left	FKM
415106-S	PD 600-700-800-900-950 6.354 PERKİNS MOT.	KRANK ARKA Crank Shaft Rear	2418F391	2236688	15026903	12010753	133,35	159,05		12,70		L3 SOL-Left	VMQ
45-009-V	PD 600-700-800-900-950 6.354 PERKİNS MOT.	SUPAP	1272T	33817117	12016623	-	9,45	14,25	16,61	10,69	14,27	L	FKM
040942-V	PD 900 AS	YAKIT POMPASI Fuel Pump	1460283311	42551388	12019586	-	20,00	31,00		7,30		L13TL	FKM
4CN-055-S	PD 700-800-900	KÜLBÜTÖR KAPAK CONTASI Rocker Cover Gasket	1478T	-	-	-	15,75	30,20		12,70	7,10	MH	VMQ
040508	PD 600 A SERISI	HAVA KOMPRESÖRÜ Air Compressor	-	-	-	-	25,00	42,00		14,00		L3L	NBR
040088	PD 600 A SERISI	HAVA KOMPRESÖRÜ Air Compressor	17H5751	E58FG5	-	-	25,40	44,52		5,15		L3	NBR
040380	PD 600 A SERISI	EKSOZTER Exhauster	T22260	3H3132	-	-	22,22	35,03		6,35		L12L	NBR
040138	PD 600 A SERISI	EKSOZTER Exhauster	30854	D31294 5	-	-	22,22	35,12		6,35		L3	NBR
040582-S	PD 600-700-800-900	EKSOZTER Exhauster	D31238	1571844T	-	-	22,22	35,94	46,04	9,92		SPL3 SAĞ -Right	VMQ
040314	PD 600 A SERISI	EKSOZTER Exhauster	D31238	5034146	-	-	22,22	36,00	46,04	8,50	9,52	SPL3	NBR

AKS GRUBU / Axle Group

SKT NO	KULLANILAN MODELLER Models	KULLANIM YERİ Place Of Use	ORJİNAL NO 1 Original No 1	ORJİNAL NO 2 Original No 2	EŞDEĞER NO 1 Equivalent No 1	EŞDEĞER NO 2 Equivalent No 2	ÖLÇÜLER - MM. Dimensions - MM.					TİP Type	MALZEME Material
410243	D 600 - 700 - 800	ÖN AKS Front Axle	4070563	1789613			73,02	104,91	98,48	9,52	20,63	SPSL	NBR
410324	PD 900-950	ÖN AKS Front Axle	3827712	-	-	-	88,90	115,62		18,79	16,25	SPSLL SS-RL	NBR
410032	PD 600 A SERİSİ	ÖN AKS Front Axle	1267215	-	-	-	88,90	123,11	123,82	11,90	23,02	SPSL	NBR
412274	DODGE- 26200	ÖN AKS Front Axle	16865-T	-	-	-	88,90	132,15	120,00	13,00	25,00	SPSLL	NBR
040652	PD 700-800-900-950	ÖN AKS KİNG PİMİ Front Axle King Pin	4543T	-	-	-	40,84	44,12		3,17		L5	NBR
410296	KAMYON SERİSİ	ARKA AKS Rear Axle	2512332	-	-	-	95,25	114,45	-	11,90	-	SLL	NBR
412121	PD 600-700-800-900	ARKA AKS Rear Axle	1925822	-	-	-	98,43	144,68		19,05		SPL1L	NBR
412062	PD 600 A SERİSİ İLAVE DİNGİL	ARKA AKS Rear Axle	-	-	-	-	117,47	143,18		12,70		L3	NBR
415157	PD 900-950	ARKA AKS Rear Axle	2955840	-	-	-	121,05	160,42	149,20	15,54	28,58	SPSL	NBR
415147	PD 900-950	ARKA AKS Rear Axle	2955840	-	-	-	121,05	160,42		28,58		SC	NBR
412130	D 600-700-PD600	ARKA AKS DIŞ Rear Axle Outer	1938206	-	-	-	78,98	146,05	12,70	128,19	11,11	SPL1	NBR
412261	PD 600 - 700 - 800	ARKA AKS KOVAN İÇ Rear Axle	1925822	4070562	-	-	98,43	144,68		19,05		SPL1L SS-RL	NBR
045497	PD 600-700-800-900	FREN MİLİ Brake Shaft	2535T	001011349	12010924	-	38,00	52,00		7,00		L3	NBR

DİFERANSİYEL GRUBU / Differential Group

SKT NO	KULLANILAN MODELLER Models	KULLANIM YERİ Place Of Use	ORJİNAL NO 1 Original No 1	ORJİNAL NO 2 Original No 2	EŞDEĞER NO 1 Equivalent No 1	EŞDEĞER NO 2 Equivalent No 2	ÖLÇÜLER - MM. Dimensions - MM.					TİP Type	MALZEME Material
047233	D 600-700-PD600	MAHRUTİ (DİFER.ÖN) Differential - Front	-	-	-	-	66,67	92,18		11,90		L1	NBR
410288-P	D 600-700-PD600	MAHRUTİ (DİFER.ÖN) Differential - Front	E81673	-	-	-	66,67	103,34	112,69	12,70	27,78	SPL1L	ACM

DİFERANSİYEL GRUBU / Differential Group

SKT NO	KULLANILAN MODELLER Models	KULLANIM YERİ Place Of Use	ORJİNAL NO 1 Original No 1	ORJİNAL NO 2 Original No 2	EŞDEĞER NO 1 Equivalent No 1	EŞDEĞER NO 2 Equivalent No 2	ÖLÇÜLER - MM. Dimensions - MM.					TİP Type	MALZEME Material
410325-NK	D 600 - 700	MAHRUTİ (DİFER.ÖN) Differential - Front	E81673	-	-	-	66,67	103,34	112,69	12,70	27,78	SPL1K SS-RL	NBR
410267-V	PD 600 A SERISI	MAHRUTİ (DİFER.ÖN) Differential - Front	2961493	E79470	01016915	-	66,67	116,02	125,40	11,90	19,25	SPL1L SS-RL	FKM
410120-NK	PD 600 A SERISI	MAHRUTİ (DİFER.ÖN) Differential - Front	-	-	-	-	66,67	116,03		12,70	22,22	SPL1K	NBR
412273-V	PD 950 AS	MAHRUTİ (DİFER.ÖN) Differential - Front	119432	-	19037022	-	74,61	125,58	136,52	12,70	31,75	SPL1LL SS-RL	FKM
410364-V	PD 900 AS	MAHRUTİ (DİFER.ÖN) Differential - Front	-	-	12013643	UH0327E	76,20	114,43	120,65	10,90	19,05	SPL1LLR SS-RL	FKM

ŞANZİMAN GRUBU / Gearbox Group

SKT NO	KULLANILAN MODELLER Models	KULLANIM YERİ Place Of Use	ORJİNAL NO 1 Original No 1	ORJİNAL NO 2 Original No 2	EŞDEĞER NO 1 Equivalent No 1	EŞDEĞER NO 2 Equivalent No 2	ÖLÇÜLER - MM. Dimensions - MM.					TİP Type	MALZEME Material
045830-P	PD 950 AS (5 VİTES ŞANZ.)	ŞANZİMAN ÖN Gearbox Front	4300798	-	-	-	41,28	63,65		7,93		L1L SAĞ -Right	ACM
045763-P	PD 700-800-900 (TURNER ŞANZ.)	ŞANZİMAN ÖN Gearbox Front	CKE66957	900576	-	-	44,45	62,10		9,52		L3	ACM
045215	PD 600 A SERISI	ŞANZİMAN ARKA Gearbox Rear	1923935	-	-	-	53,98	73,12		12,82	15,03	SPSL	NBR
047598-P	PD 600-700-800-900-950 (TURNER ŞANZ.)	ŞANZİMAN ARKA Gearbox Rear	CKC66960	-	-	-	66,67	85,75		11,11	14,28	L1L SOL-Left	ACM
047648-P	PD 950 AS (EATON 5 VİTES ŞANZ.)	ŞANZİMAN ARKA Gearbox Rear	4300119	7142219	19025917	-	70,00	90,00		13,00		L1L SS-RL	ACM
410403-V	AS 19.300 ST	ŞANZİMAN ARKA Gearbox Rear	0734319459	1297604	01026691	-	105,00	125,00		12,00	9,50	L13TL SOL -Left	FKM
4P-262-V	HINO 19-300 26-300 32-300 38-300	ŞANZİMAN PİSTON KEÇESİ Gearbox U Packing Seal	0750112089	-	504.540	5045400	53,00	63,00		16,20		PCX4	FKM

DİREKSİYON GRUBU / Steering Group

SKT NO	KULLANILAN MODELLER Models	KULLANIM YERİ Place Of Use	ORJİNAL NO 1 Original No 1	ORJİNAL NO 2 Original No 2	EŞDEĞER NO 1 Equivalent No 1	EŞDEĞER NO 2 Equivalent No 2	ÖLÇÜLER - MM. Dimensions - MM.				TİP Type	MALZEME Material	
040108	PD 600 A SERISI	DİREKSİYON KUTUSU Steering Box	2207306	1408732	-	-	19,05	33,42		7,93		L4	NBR
040055	PD 600 A SERISI	DİREKSİYON KUTUSU Steering Box	2825713	-	-	-	22,22	33,32		6,35		L5	NBR
040320	D 600 - 700	DİREK. SEKTÖR MİLİ Steering Sector Shaft	1484523	-	-	-	31,75	42,95		7,93		L3L	NBR
040056	D 600 - 700	DİREK. SEKTÖR MİLİ Steering Sector Shaft	1138281	1J1902	19033339	-	31,75	42,98		4,76		L5	NBR
040074	D 600 - 700	DİREK. SEKTÖR MİLİ Steering Sector Shaft	1192615	-	-	-	33,34	46,53		9,52		SL	NBR
040312	D 600 - 700	DİREK. SEKTÖR MİLİ Steering Sector Shaft	1483929	-	-	-	34,92	46,71		5,55		L1	NBR
040662	PD 700 - 800 - 900	HİDROLİK DİREKSİYON SİST. Hydraulic Steering System	5692683	-	-	-	15,87	31,85		6,35		L12BL	NBR
040645	PD 700 - 800 - 900	HİDROLİK DİREKSİYON SİST. Hydraulic Steering System	D31294	668489	-	-	22,22	35,12		6,35		L3BL	NBR
045754	PD 700 - 800 - 900	HİDROLİK DİREKSİYON SİST. Hydraulic Steering System	7816424	-	-	-	41,28	54,22		7,93		L3B	NBR
4TM-041	PD 700-800-900	HİDROLİK DİREKSİYON SİST. Hydraulic Steering System	3736349	-	-	-	-	-		-		TM	-

MOTOR GRUBU / Engine Group

SKT NO	KULLANILAN MODELLER Models	KULLANIM YERİ Place Of Use	ORJİNAL NO 1 Original No 1	ORJİNAL NO 1 Original No 2	EŞDEĞER NO 1 Equivalent No 1	EŞDEĞER NO 1 Equivalent No 2	ÖLÇÜLER - MM. Dimensions - MM.					TİP Type	MALZEME Material
047811-V	ESKİ MODELLER	KRANK ÖN Crank Shaft Front	1226734	0240631	12014700	763.144	70,00	90,00		10,00		L13TL SAĞ -Right	FKM
047475-S	ESKİ MODELLER	KRANK ÖN Crank Shaft Front	702672445	-	19030094	128.210	80,00	100,00		13,00		L3 SOL-Left	VMQ
410490-FPK	85-95-CF85-XF95 SERİLERİ	KRANK ÖN Crank Shaft Front	1275084	1340321	15027586	493.330	100,00	124,00		12,00		F2TK SAĞ -Right	PTFE+ACM YÜN-NW
047049-S	55/66 99 MOD.	KRANK ARKA Crank Shaft Rear	702660275	702607235	16012790	513.326	70,00	90,00		10,00		L3 SOL-Left	VMQ
417112-FPK	85-95-XF-CF SERİLERİ	KRANK ARKA Crank Shaft Rear	1340320	0681704	20029771	175.990	154,00	180,00		12,00		F2TK SOL -Left	PTFE+ACM YÜN-NW
417088-S	2800-3300	KRANK ARKA Crank Shaft Rear	-	-	-	-	154,00	180,00		18,00		L3TL SOL -Left	VMQ
45-040-V	TÜM XF-XE MODELLER	SUPAP Valve Stem Seal	1455246	-	732.120	-	9,00	15,85	17,67	14,60	13,60	LSYT	FKM
040942-V	EUROCARGO-150	YAKIT POMPASI Fuel Pump	CBU2006	CBU2482	12019586	-	20,00	31,00		7,30		L13TL	FKM
040956-V	85-95 XF	YAKIT POMPASI Fuel Pump	1284159	1323842	00029786	-	34,00	50,00		10,00		L3TL SOL -Left	FKM
040144	ESKİ MODELLER	SU POMPASI Water Pump	0119198	-	12010859	671.908	25,00	47,00		10,00		L3	NBR
040507	KAMYON-CEKİCİ	ŞARJ DİNAMOSU Charge System	606625	-	-	-	32,00	42,00	-	7,00	10,00	L1C	NBR
041179	2800	HAVA KOMPRESÖRÜ Air Compressor	-	-	12012574	237.744	28,00	40,00		7,00	8,00	L3BLL	NBR

AKS GRUBU / Axle Group

SKT NO	KULLANILAN MODELLER Models	KULLANIM YERİ Place Of Use	ORJİNAL NO 1 Original No 1	ORJİNAL NO 1 Original No 2	EŞDEĞER NO 1 Equivalent No 1	EŞDEĞER NO 1 Equivalent No 2	ÖLÇÜLER - MM. Dimensions - MM.					TİP Type	MALZEME Material
410476-V	CF-XF	ÖN AKS RULMANI Front Axle Bearing	808051	-	-	-	98,00	120,00	-	7,50	-	SPL5	FKM
410475-V	XF-CF SERİSİ	ÖN AKS RULMANI Front Axle Bearing	-	-	-	-	98,00	125,00	133,70	7,35	9,65	SPSC8	FKM
412272	2100-2500-2700-2800-3300 SERİSİ	ÖN AKS Front Axle	0099976747	0109979046	12000552	814.172	100,00	130,00		13,00		L3TL	NBR

AKS GRUBU / Axle Group

SKT NO	KULLANILAN MODELLER Models	KULLANIM YERİ Place Of Use	ORJİNAL NO 1 Original No 1	ORJİNAL NO 2 Original No 2	EŞDEĞER NO 1 Equivalent No 1	EŞDEĞER NO 2 Equivalent No 2	ÖLÇÜLER - MM. Dimensions - MM.					TİP Type	MALZEME Material
412248	3300-2800-3600-F65-75-85-95	ÖN AKS Front Axle	0647330	-	12015029	-	100,00	135,00		13,00		L3L	NBR
412319	95XF480-95ATI-85ATI	ÖN AKS Front Axle	1238034	VKS6333	12015758	-	100,00	140,00		15,00	20,50	SLLLR	NBR
415211	75CF-85CF-95XF	ÖN AKS Front Axle	1334961	-	01026332	-	100,00	140,00	166,00	16,00	22,00	SPL1LR SS -RL ABS	NBR
045973	-	ÖN AKS KİNG PİMİ Front Axle King Pin	0657062	-	01012190	-	50,00	58,00		4,00		L2	NBR
410484	F2800	ARKA AKS Rear Axle	1313719	1409890	12017173	222.610	75,00	100,00		10,00	13,00	SPSC	NBR
410121	XF 105	ARKA AKS Rear Axle	1602361	-	12011209	-	100,00	120,00		12,00		L3	NBR
410121-V	XF 105	ARKA AKS Rear Axle	1602361	-	12011209	-	100,00	120,00		12,00		L3	FKM
412393-V	XF-YENİ MOD. (FAG RULMAN İÇİN)	ÖN-ARKA AKS RULMANI Front-Rear Axle Bearing	356014382 SET	-	0293 V30	-	125,00	142,00		8,00	9,20	SC	FKM
415196	F65-85-F75-F95XF	ARKA AKS Rear Axle	0292766	350984	01015140	-	125,00	160,00		15,50	20,00	SC5	NBR
415196-V	F65-F75-F85-95XF-480	ARKA AKS Rear Axle	292766	350984	01015140	-	125,00	160,00		15,50	20,00	SC5	FKM
420065-VP	75CF-85CF-95XF-CF85-XF95-XF105-510	ARKA AKS Rear Axle	1335063	-	01026336	-	125,00	160,00	190,00	18,00	20,00	SCSS-RL ABS	FKM+ACM
417041	2800-3300	ARKA AKS Rear Axle	38529750	40001650	12011376	-	160,00	185,00		12,70		L1L	NBR
412353-V	ZF AKSLI MODELLER	ARKA AKS RULMANI Rear Axle Bearing Seal	-	-	-	-	125,00	148,00		7,00	9,70	SPLL13SS-RL	FKM
412354-V	ZF AKSLI MODELLER	ARKA AKS RULMANI Rear Axle Bearing Seal	-	-	-	-	125,00	148,30	156,00	8,10	9,30	SC	FKM
4TM-089	ZF AKSLI MODELLER	ARKA AKS TAMİR TAKIMI Rear Axle Repair Kit	3095043	3095042	19037007	735.540						TM	
4TM-162	ZF AKSLI MODELLER (412353-V+412354-V)	ARKA AKS TAMİR TAKIMI Rear Axle Repair Kit	3095043	3095042	19037007	-						TM	
4TM-159	CF-XF Çekici Serisi (410475-V+410476-V)	ARKA AKS TAMİR TAKIMI Rear Axle Repair Kit	808051	-	-	-						TM	
045645	TÜM MODELLER	FREN MİLİ Brake Shaft	213966	-	19031938	-	42,00	56,00		7,00		L3T	NBR

DİFERANSİYEL GRUBU / Differential Group

SKT NO	KULLANILAN MODELLER Models	KULLANIM YERİ Place Of Use	ORJİNAL NO 1 Original No 1	ORJİNAL NO 2 Original No 2	EŞDEĞER NO 1 Equivalent No 1	EŞDEĞER NO 2 Equivalent No 2	ÖLÇÜLER - MM. Dimensions - MM.				TİP Type	MALZEME Material	
045330	-	MAHRUTİ (DİFER.ÖN) Differential - Front	0586697	-	12011331	040.991	48,00	65,00		10,00	L1	NBR	
047232	F75	MAHRUTİ (DİFER.ÖN) Differential - Front	1242747	1242740	12011006	-	64,00	80,00		8,00	L3	NBR	
410450-V	85CF-95XF-CF85-XF95-XF105-510	MAHRUTİ (DİFER.ÖN) Differential - Front	0538953	0077477	01017056	504.560	85,00	110,00		12,00	17,00	L13LLR	FKM
412320-V	85CF-95XF-CF85-XF95-XF105-510	MAHRUTİ (DİFER.ÖN) Differential - Front	1287102	-	01027965	-	85,00	140,00		13,00	17,00	L13TLLR SAĞ-Right	FKM
410299	45-130	MAHRUTİ (DİFER.ÖN) Differential - Front	0491901	NAK9256	12011826	12011043	90,00	110,00		12,00		L3L	NBR
045822	8X4/85CF-340/CF85-340	MAHRUTİ ARKA İÇ Differential - Rear / Inside	1256591	-	01002633	-	55,00	70,00		8,00		L3L	NBR
047521	8X4/85CF-340/CF85-340-F75-F85-F95	MAHRUTİ ARKA İÇ Differential - Rear / Inside	1256592	-	01020468	104.320	80,00	100,00		10,00		L1L	NBR

ŞANZİMAN GRUBU / Gearbox Group

SKT NO	KULLANILAN MODELLER Models	KULLANIM YERİ Place Of Use	ORJİNAL NO 1 Original No 1	ORJİNAL NO 2 Original No 2	EŞDEĞER NO 1 Equivalent No 1	EŞDEĞER NO 2 Equivalent No 2	ÖLÇÜLER - MM. Dimensions - MM.				TİP Type	MALZEME Material	
046021-VK	45 SERİSİ ZF55-42	ŞANZİMAN ÖN Gearbox Front	1447221	-	01029649	12019650	40,00	52,00		8,50		L3TL SAĞ -Right	FKM YÜN-NW
046132-P	CF65-LF45	ŞANZİMAN ÖN Gearbox Front	0585903	1679051	12013896	040.363	42,00	62,00		10,00		L3TL SAĞ -Right	ACM
045536	2800-3300 EATON - FULLER ŞANZ.	ŞANZİMAN ÖN Gearbox Front	-	-	-	-	48,00	58,00		4,00		L2	NBR
045827-V	F65-75 ZF 9S75-109	ŞANZİMAN ÖN Gearbox Front	0699617	-	20016209	586.676	48,00	65,00		10,00		L13TL SAĞ -Right	FKM
045840-V	-	ŞANZİMAN ÖN Gearbox Front	0110466	0609458	12011307	033.472	48,00	75,00		8,00		L1 SAĞ-Right	FKM
045964-V	ZF 16S151	ŞANZİMAN ÖN Gearbox Front	1296692	-	12018806	141.960	52,00	68,00		8,00		L13TL SAĞ -Right	FKM
045990-V	F75-XF95-XF105	ŞANZİMAN ÖN Gearbox Front	1615787	-	12015120	419.370	55,00	70,00		8,00		L13TL SAĞ -Right	FKM
045851-V	75CF-85CF-95XF-CF75-CF85-XF95	ŞANZİMAN ÖN Gearbox Front	0734310111	0734310386	12011308	284.645	55,00	75,00		8,00		L1 SAĞ-Right	FKM

ŞANZIMAN GRUBU / Gearbox Group

SKT NO	KULLANILAN MODELLER Models	KULLANIM YERİ Place Of Use	ORJİNAL NO 1 Original No 1	ORJİNAL NO 2 Original No 2	EŞDEĞER NO 1 Equivalent No 1	EŞDEĞER NO 2 Equivalent No 2	ÖLÇÜLER - MM. Dimensions - MM.					TİP Type	MALZEME Material
046115-P	75-85-95 SERİSİZF 16S 181-221	ŞANZIMAN ÖN Gearbox Front	1658481	0069558	01031969	515.340	55,00	75,00		8,00	9,20	L1R SAĞ -Right	ACM
045880-V	S6-85-F16	ŞANZIMAN ÖN İÇ Gearbox Front	0140540	0608590	12011306	284.662	48,00	69,00		10,00		L1 SAĞ-Right	FKM
046011	75CF-F65 ZF 9S75-9S109	ŞANZIMAN ÖN Gearbox Front	1288043	-	01017792	-	60,00	74,80		4,70		SPL5	NBR
041051-V	-	ŞANZIMAN KULESİ Gearbox Tower	0692237	-	12015769	457.290	25,00	38,00	49,50	14,50		SPL3TL	FKM
045567-V	F45-F55-LF45-LF55	ŞANZIMAN ARKA Gearbox Rear	0585910	-	12013365	-	60,00	74,00		10,00		L1	FKM
047839-VAE	KAMYON-ÇEKİCİ SERİSİ ZF S5-422	ŞANZIMAN ARKA Gearbox Rear	0140784	702607235	20027594	12014536	70,00	90,00	-	10,00	-	L3TL SOL -Left	FKM+AEM
047645-V	MAGNUM EATON 8209-420 19T	ŞANZIMAN ARKA Gearbox Rear	1456286	-	12013860	034.347	78,00	100,00		10,00		L13TL SOL -Left	FKM
047650-V	65 - 75 CF ZF 9S75	ŞANZIMAN ARKA Gearbox Rear	3386430	1543908	20027920	587.966	80,00	100,00		8,00		L3TL SOL -Left	FKM
047711-V	65-75 CF- ZF 9S75	ŞANZIMAN ARKA Gearbox Rear	3386430	1543908	01020467	587.966	80,00	100,00		10,00		L13TL SS-RL	FKM
410386-V	-	ŞANZIMAN ARKA Gearbox Rear	0140783	0609475	12013757	033.464	85,00	105,00		8,00		L3TL SOL -Left	FKM
410227	KAMYON SERİSİ	ŞANZIMAN ARKA Gearbox Rear	0585373	-	12011340	556.807	85,00	105,00		10,00		L1	NBR
410368-V	FULLER TİP	ŞANZIMAN ARKA Gearbox Rear	0696084	-	12012235	967.850	95,30	114,29		11,88		L13TL SS-RL	FKM
410403-V	TÜM MODELLER ZF 9S109 -16S 151-181	ŞANZIMAN ARKA Gearbox Rear	1297604	07344319459	01026691	-	105,00	125,00		12,00	9,50	L13TL SOL -Left	FKM
412290-V	XF85-XF95	ŞANZIMAN ARKA-DIŞ Gearbox Rear - Outer	0069603	1304242	01018282	314.994	105,00	130,00		11,00		L13L SOL -Left	FKM
412344-V	ZF 16S 181-221/85CF-95XF-CF85-XF95-XF105	ŞANZIMAN ARKA Gearbox Rear	1304242	0069603	01016923	490.840	105,00	130,00		12,00		L13TL SOL -Left	FKM
047830-P	TÜM MODELLER ZF 16S 151-181	ŞANZIMAN YARDIMCI MİLİ Gearbox Auxiliary Shaft	1240023	-	01017789	-	77,00	95,30		6,00		L5	ACM
040844	75-85-95 XF/CF SERİSİ	VİTES SEÇİCİ MİLİ Gear Selection Shaft	0140335	-	12014616	038.083	25,00	35,00	-	6,00	-	L3BTL	NBR
040774-V	TÜM MODELLER ZF 9S75 ŞANZ.	ŞANZIMAN KLM.ÇIKIŞ MİLİ Speedometer Shaft	0634300185	06344300105	01002259	010.804	10,00	15,00		3,00		SPL5	FKM

ŞANZİMAN GRUBU / Gearbox Group

SKT NO	KULLANILAN MODELLER Models	KULLANIM YERİ Place Of Use	ORJİNAL NO 1 Original No 1	ORJİNAL NO 2 Original No 2	EŞDEĞER NO 1 Equivalent No 1	EŞDEĞER NO 2 Equivalent No 2	ÖLÇÜLER - MM. Dimensions - MM.				TİP Type	MALZEME Material	
040182	65-75-85-95CF	ŞANZ. DEBRİYAJ KEÇESİ Clutch Shaft Seal	0586784	586784	01002369	164.500	14,00	24,00		7,00		L3	NBR
041177	TÜM MODELLER ZF 9S75-16S 181-221	ŞANZ. DEBRİYAJ KEÇESİ Clutch Shaft Seal	0140335	-	12014616	038.083	25,00	35,00		7,00		L13TL	NBR
041106-V	TÜM MODELLER ZF 16S 181/XF85-9S SERİSİ	ŞANZİMAN KULESİ Gearbox Tower	1295232	1784507	01029609	733.480	25,00	40,00	49,00	15,00		SPL13CTL	FKM
041108-NL	ZF 16S 151/CF85-9SXF-XF95-XF105	ŞANZ. DEBRİYAJ KEÇESİ Clutch Shaft Seal	1385519	-	01030095	-	28,00	42,00		11,00		SPL13TL	NBR+TPU
4MH-415-H	TÜM MODELLER ZF 16S 151	VİTES KUMANDA KULESİ Gear Control System	1291086	0750112177	01034594	-	55,00	63,00		9,40		L	HNBR
041113	TÜM MODELLER ZF 9S75 ŞANZ.	ŞANZ. DEBRİYAJ KEÇESİ Clutch Shaft Seal	0501312738	-	12015561	01026544	30,00	37,00		7,00		L2T	NBR
041110-V	XF85-XF95 ZF 9S109-16S109	ŞANZİMAN KULESİ Gearbox Tower	0699733	699733	01029805	-	22,00	36,00	48,00	14,50		SPL3CTL	FKM
041111-V	TÜM MODELLER ZF 9S75 ŞANZ.	ŞANZİMAN KULESİ Gearbox Tower	1347259	0501316333	01032393	-	22,00	36,00	57,00	14,50		SPL3CTL	FKM
041109-V	-	ŞANZİMAN KULESİ Gearbox Tower	0692237	-	12015769	457.290	25,00	38,00	49,50	14,50		SPL3CTL	FKM
4P-228-H	ZF16S 151-181-221-2220-2221-2521-2330-2331ŞANZ.	ŞANZ. AKTAR. PİSTONU Gearbox Piston	1317285	0734307294	49378203	-	50,00	90,00		7,50		PC	HNBR
4P-262-V	LF45-75.270-75.300-85XF-75XF	ŞANZİMAN PİSTON KEÇESİ Gearbox U Packing Seal	0750112089	-	504.540	5045400	53,00	63,00		16,20		PCX4	FKM
4P-262-V	9S109-16S109-130-150-151-181-221 ŞANZ.	ŞANZİMAN PİSTON KEÇESİ Gearbox U Packing Seal	066388	-	504.540	5045400	53,00	63,00		16,20		PCX4	FKM
040713	FULLER ŞANZ.	ŞANZİMAN TAKVİYE MİLİ Gear Reinforcement Shaft	FBU5520	-	12002188	120.103	22,00	35,00		7,00			FKM
4P-260-H	ZF 9S75 ŞANZ.	TAKVİYE PİSTON KEÇESİ Reinforcement Piston Seal	1347260	0734309377	12014451	-	63,00	16,00		10,50		LS	HNBR

DİREKSİYON GRUBU / Steering Group

SKT NO	KULLANILAN MODELLER Models	KULLANIM YERİ Place Of Use	ORJİNAL NO 1 Original No 1	ORJİNAL NO 2 Original No 2	EŞDEĞER NO 1 Equivalent No 1	EŞDEĞER NO 2 Equivalent No 2	ÖLÇÜLER - MM. Dimensions - MM.				TİP Type	MALZEME Material	
040745	-	DİREKSİYON MİLİ Steering Shaft	1456528	1604095	12011122	038.075	25,00	35,00		7,00		L3TL	NBR
040846	2800-3300	DİREKSİYON MİLİ Steering Shaft	-	-	01033711	-	25,00	37,00		6,00		L3BTL	NBR
041186	-	DİREKSİYON MİLİ Steering Shaft	0066322	0770198134	01020066	-	26,00	34,00		4,50	7,00	SPL3BL	NBR
045658	XF95 SERİSİ	DİREKSİYON MİLİ Steering Shaft	1255264	-	01034647	-	50,00	75,00		10,00		L3L	NBR
040929	LF SERİSİ	DİREKSİYON KUTUSU Steering Box	0770080252	0770198134	01020066	-	26,00	34,00		4,50	7,00	SPL3BL	NBR
041148-H	80-95	DİREKSİYON KUTUSU Steering Box	-	-	-	-	26,00	38,50		5,65	7,47	SPL3L	HNBR
4TM-086	TAS-75 TRW	DİREKSİYON KUTUSU Steering Box	-	-	-	-						TM	-
040541	2800-3300	DİREKSİYON POMPASI Power Steering Pump	-	-	-	-	17,00	28,00		8,00			NBR

MOTOR GRUBU / Engine Group

SKT NO	KULLANILAN MODELLER Models	KULLANIM YERİ Place Of Use	ORJİNAL NO 1 Original No 1	ORJİNAL NO 2 Original No 2	EŞDEĞER NO 1 Equivalent No 1	EŞDEĞER NO 2 Equivalent No 2	ÖLÇÜLER - MM. Dimensions - MM.					TİP Type	MALZEME Material
047821-FK	CARGO 2520-2621-2626	KRANK ÖN Crank Shaft Front	976T6700A2A	-	-	-	66,67	89,30		9,50		F2TK SAĞ -Right	PTFE +YÜN-NW
047562-S	CARGO DOWER MOT.SERİSİ	KRANK ÖN Crank Shaft Front	826F6700D2A	-	-	-	66,67	89,70		9,52		L3TL SAĞ -Right	VMQ
047562-V	CARGO DOWER MOT.SERİSİ	KRANK ÖN Crank Shaft Front	926T6700A1A	-	12015552	-	66,67	89,70		9,52		L3TL SAĞ -Right	FKM
410491-VK	KARGO 1827-3227 DEUTZ 1013 MOT	KRANK ÖN Crank Shaft Front	20412568	04253373	01027762	084.920	81,00	104,00		11,00		L13TL SAĞ -Right	FKM +YÜN-NW
412337-FP	CARGO NHDD-ECOTORQ MOT.-1824-3230	KRANK ÖN Crank Shaft Front	2C466700AA	-	12018854	-	105,00	135,00		13,00	17,00	SCF7 SAĞ -Right	PTFE+ACM
412338-FP	CARGO NHDD-ECOTORQ MOT.-1824-3230	KRANK ARKA Crank Shaft Rear	2C466701AA	2C4Q6701AA	20035708	-	105,00	140,00		12,00		F2TLK SOL -Left	PTFE+ACM
412384-VAEK	KARGO 1827-3227 DEUTZ 1013 MOT	KRANK ARKA Crank Shaft Rear	20412286	04253333	01027763	NA5475	130,00	150,00		13,00		L3TL SOL -Left	FKM +AEM+ YÜN-NW
047494-S	D 1210-1314	EKSANTRİK MİLİ Cam Shaft	504E6362	E1ANKN6362B	-	-	66,67	89,03		12,70		L1L	VMQ
047255	D 1210-1312	EKSANTRİK MİLİ Cam Shaft	E1ANKN6362B	-	-	-	66,67	89,10		12,70		L3L	NBR
047255-S	D 1210-1312	EKSANTRİK MİLİ Cam Shaft	E1ANKN6362B	540E6362	-	-	66,67	89,10		12,70		L3L	VMQ
45-058-V	CARGO SERİSİ NHDD MOT.	SUPAP Valve Stem Seal	6C466571AA	-	-	-	8,00	12,00	14,20	9,50		LSY	FKM
45-016	FORD 1210-1312	SUPAP Valve Stem Seal	E0TA6571C	-	704514300	KG218	8,00	18,50	22,35	10,20	12,70	LA3	NBR
45-006-V	CARGO-DOWER MOT.	SUPAP Valve Stem Seal	826F6571DA	-	-	-	9,48	15,90	21,80	12,90	18,05	LY1	FKM
45-015-C	CARGO-DOWER MOT.	SUPAP Valve Stem Seal	813F6571DAA	-	-	-	9,30	20,00	22,00	12,60	16,40	LA2	PA
040572	CARGO TÜM MODELLER	YAKIT POMPASI Fuel Pump	826F9C521DAA	1791096	00527800	NB077	15,87	39,70		11,11	11,50	SPL2	NBR
040506	D 1210-1312	YAKIT POMPASI Fuel Pump	E1ADDN2A569	-	-	-	20,00	35,00		8,00		L3X	NBR
040506-V	D 1210-1312	YAKIT POMPASI Fuel Pump	E1ADDN2A569	-	-	-	20,00	35,00		8,00		L3X	FKM
4MH-284	CARGO TÜM MODELLER	MOTOR YAĞ SOĞ. SİST. Engine Oil Cooler Sys.	826F6C001EAA	-	-	-	16,81	22,65		3,05		L	NBR

MOTOR GRUBU / Engine Group

SKT NO	KULLANILAN MODELLER Models	KULLANIM YERİ Place Of Use	ORJİNAL NO 1 Original No 1	ORJİNAL NO 2 Original No 2	EŞDEĞER NO 1 Equivalent No 1	EŞDEĞER NO 2 Equivalent No 2	ÖLÇÜLER - MM. Dimensions - MM.					TİP Type	MALZEME Material
4H-460-S	CARGO 2014-2517-2520-2621	MOTOR YAĞ SOĞ. SİST. Engine Oil Cooler Sys.	-	-	-	-	102,00			4,00		O	VMQ
4H-093	CARGO 2014-2517-2520-2621	MOTOR YAĞ SOĞ. SİST. Engine Oil Cooler Sys.	826F6K712AA	-	-	-	104,40			3,53		O	NBR
040508	D 1210-1312	HAVA KOMPRESÖRÜ Air Compressor	-	-	-	-	25,00	42,00		14,00		L3L	NBR
040088	1210-1312	EKSOZTER Exhauster	17H5751	E58FG5	-	-	25,40	44,52		5,15		L3	NBR

AKS GRUBU / Axle Group

SKT NO	KULLANILAN MODELLER Models	KULLANIM YERİ Place Of Use	ORJİNAL NO 1 Original No 1	ORJİNAL NO 2 Original No 2	EŞDEĞER NO 1 Equivalent No 1	EŞDEĞER NO 2 Equivalent No 2	ÖLÇÜLER - MM. Dimensions - MM.					TİP Type	MALZEME Material
410032	CARGO 1312-1210-2014	ÖN AKS Front Axle	200E1190C1	-	-	-	88,90	123,11	123,82	11,90	23,02	SPSL	NBR
412237	TÜM CARGO MODELLERİ	ÖN AKS Front Axle	3C461190AA	EC461190AA	-	-	101,60	133,50		12,70		SLL	NBR
412377	TÜM CARGO MODELLERİ	ÖN AKS Front Axle	EC461190AA	-	-	-	101,60	133,30		12,70		SC	NBR
046247-V	YENİ CARGO SERİSİ	ARKA AKS KOVAN Rear Axle	1522373	-	20019176	-	50,00	65,00		8,00		L1 SS-RL	FKM
412393-V	YENİ MOD. (FAG RULMAN İÇİN)	ÖN-ARKA AKS RULMANI Front-Rear Axle Bearing	356014382 SET	-	0293 V30	-	125,00	142,00		8,00	9,20	SC	FKM
4TM-109	FORD CARGO ZF DİNGİL	ARKA AKS TAMİR TAKIMI Rear Axle Repair Kit	-	-	-	-							
415100	D 1210-1312	ARKA AKS DIŞ Rear Axle Outer	2000E4245A	-	-	-	63,50	155,20	133,35	11,11	13,20	SPL1	NBR
420057	D 1812-2114-2014-2517-2520	ARKA AKS DIŞ Rear Axle Outer	2002E4245C1	-	NA977	-	69,85	208,02	19,80	177,80	10,40	SPL1L	NBR
410196	CARGO 2621-2626	ARKA AKS DIŞ Rear Axle Outer	92CT4M245AA	-	-	-	92,08	111,28		9,52		SL	NBR
410196-V	CARGO 2621-2626	ARKA AKS DIŞ Rear Axle Outer	92CT4M245AA	8C464245AA	-	-	92,08	111,28		9,52		SL	FKM

AKS GRUBU / Axle Group

SKT NO	KULLANILAN MODELLER Models	KULLANIM YERİ Place Of Use	ORJİNAL NO 1 Original No 1	ORJİNAL NO 2 Original No 2	EŞDEĞER NO 1 Equivalent No 1	EŞDEĞER NO 2 Equivalent No 2	ÖLÇÜLER - MM. Dimensions - MM.					TİP Type	MALZEME Material
420071-V	1842 T-2542 S-3242 S-2533 S-3233 S SERİSİ	ARKA AKS DIŞ (10 delik) Rear Axle Outer (10 hole)	FC464124AA	-	-	-	92,08	215,30		7,80		SPL1L 10	FKM
420060	CARGO 2626-3227-F-MAX	ARKA AKS DIŞ Rear Axle Outer	-	-	-	-	92,08	215,30	15,00	190,30	10,50	SPL1L	NBR
420060-V	CARGO 2626-3227-F-MAX	ARKA AKS DIŞ Rear Axle Outer	-	-	-	-	92,08	215,30	15,00	190,30	10,50	SPL1L	FKM
412121	FORD 1210-1312	ARKA AKS DIŞ Rear Axle Outer	-	-	-	-	98,43	144,68		19,05		SPL1L	NBR
412148	D 1210-1312-1812-2114	ARKA AKS İÇ Rear Axle Inner	2000E1175A	-	-	-	98,43	144,65		12,70		SL	NBR
412261	CARGO - ESKİ MODEL	ARKA AKS İÇ Rear Axle Inner	-	-	-	-	98,43	144,68		19,05		SPL1L SS-RL	NBR
412141	D 1210-1312	ARKA AKS İÇ Rear Axle Inner	2000E1175A	-	-	-	98,43	144,71		12,70		L3	NBR
415214	YENİ MODEL CARGO	ARKA AKS İÇ Rear Axle Inner	AC465B830AA	9C465B830AA	-	-	110,00	150,00		12,00		L3TLL	NBR
415214-V	YENİ MODEL CARGO	ARKA AKS İÇ Rear Axle Inner	AC465B830AA	9C465B830AA	-	-	110,00	150,00		12,00		L3TLL	FKM
415151	TÜM CARGO MODELLERİ	ARKA AKS İÇ Rear Axle Inner	3C461175BA	-	-	-	111,13	158,90		14,28		SLL	NBR
415151-V	TÜM CARGO MODELLERİ	ARKA AKS İÇ Rear Axle Inner	8C461175BA	-	-	-	111,13	158,90		14,28		SLL	FKM
415180	CARGO 2014-2517-2520-2621	ARKA AKS İÇ Rear Axle Inner	3C461175BA	-	-	-	111,13	158,90	159,20	14,80		L13TL SS-RL	NBR
417130-VN	CARGO 3230-YENİ MODELLER-F-MAX	ARKA AKS İÇ Rear Axle Inner	AC461175AA	001251544	12014852	-	155,00	190,00		14,50	16,00	SC6	FKM+NBR
417124-V	CARGO 3230-YENİ MODELLER-F-MAX	ARKA AKS İÇ Rear Axle Inner	AC461175AA	123601601	12014852	-	155,00	190,00		14,50	16,00	SC6	FKM
420037	CARGO 2524-2626-3227-3230	ARKA AKS İÇ Rear Axle Inner	92CT1175BA	3C461175AA	-	-	165,10	203,37		12,70		SLL	NBR
420037-V	CARGO 2524-2626-3230	ARKA AKS İÇ Rear Axle Inner	92CT1175BA	8C461175AA	-	-	165,10	203,37		12,70		SLL	FKM
412342	CARGO 3530 6X4	ARKA AKS İÇ Rear Axle Inner	8C465B830AA	-	-	-	120,00	150,00		12,00		L3TLL	NBR
417129-HN	CARGO 3536-4136-4142 (FUWA DİFR.)	ARKA AKS Rear Axle	FC461175BA	T217008	3930248	-	134,00	165,50	187,00	16,00	25,00	SC11	HNBR+NBR

AKS GRUBU / Axle Group

SKT NO	KULLANILAN MODELLER Models	KULLANIM YERİ Place Of Use	ORJİNAL NO 1 Original No 1	ORJİNAL NO 2 Original No 2	EŞDEĞER NO 1 Equivalent No 1	EŞDEĞER NO 2 Equivalent No 2	ÖLÇÜLER - MM. Dimensions - MM.					TİP Type	MALZEME Material
412353-V	ZF AKSLI MODELLER	ARKA AKS RULMANI Rear Axle Bearing Seal	-	-	-	-	125,00	148,00		7,00	9,70	SPLL13SS-RL	FKM
412354-V	ZF AKSLI MODELLER	ARKA AKS RULMANI Rear Axle Bearing Seal	-	-	-	-	125,00	148,30	156,00	8,10	9,30	SC	FKM
4TM-089	ZFAKS.MODEL (412353-V+412354-V+4MH-425)	ARKA AKS TAMİR TAKIMI Rear Axle Repair Kit	3095043	3095042	19037007	735.540						TM	-
4TM-162	ZF AKSLI MODELLER (412353-V+412354-V)	ARKA AKS TAMİR TAKIMI Rear Axle Repair Kit	3095043	3095042	19037007	-						TM	-
4TM-105	CARGO 3536-4136-4142 (417129-HN+4H-974 FUWA DİFR.)	ARKA AKS TAMİR TAKIMI Rear Axle Repair Kit	-	-	-	-							
4H-974	CARGO 3536-4136-4142 (FUWA DİFR.)	ARKA AKS ORİNGİ Rear Axle O-ring	FC461A139A7	T216980	-	-	256,70			5,33		O	NBR
4D-406-S	CARGO YENİ MOD.(ROCKWELL SIMP. 410)	FREN MİLİ Brake Pad Dust Seal	1205X2000	42531677	-	-	14,70	42,90	53,00	28,00		D	VMQ
4D-270-S	CARGO 2014-2517-2520-2621	FREN MİLİ Brake Pad Dust Seal	1205C1667	-	-	-	14,70	53,00		17,00		LS	VMQ
4D-271-S	CARGO 2014-2517-2520-2621	FREN MİLİ Brake Pad Dust Seal	1205B1666	-	-	-	14,70	53,00		28,00		LS	VMQ
4D-410-S	CARGO YENİ MOD.(ROCKWELL 410)	FREN MİLİ Brake Pad Dust Seal	1205E2683	42537841	-	-	25,00	47,85		11,70		D	VMQ

DİFERANSİYEL GRUBU / Differential Group

SKT NO	KULLANILAN MODELLER Models	KULLANIM YERİ Place Of Use	ORJİNAL NO 1 Original No 1	ORJİNAL NO 2 Original No 2	EŞDEĞER NO 1 Equivalent No 1	EŞDEĞER NO 2 Equivalent No 2	ÖLÇÜLER - MM. Dimensions - MM.					TİP Type	MALZEME Material
047494-P	D 1210-1313	MAHRUTİ (DİFER.ÖN) Differential - Front	504E6362	E1ANKN6362B	-	-	66,67	89,03		12,70		L1L	ACM
047233	D 1210-1312	MAHRUTİ (DİFER.ÖN) Differential - Front	114209	-	-	-	66,67	92,18		11,90		L1	NBR
410288-P	D 1210-1312 16000 SERİ	MAHRUTİ (DİFER.ÖN) Differential - Front	E81673	-	-	-	66,67	103,34	112,69	12,70	27,78	SPL1L	ACM
410325-NK	D 1210-1312 16000 SERİ	MAHRUTİ (DİFER.ÖN) Differential - Front	E81673	-	-	-	66,67	103,34	112,69	12,70	27,78	SPL1K SS-RL	NBR+YÜN- NW
410267-V	D1812-2114-2517 18000 SERİ	MAHRUTİ (DİFER.ÖN) Differential - Front	119427	-	01016915	-	66,67	116,02	125,40	11,90	19,25	SPL1L SS-RL	FKM

DİFERANSİYEL GRUBU / Differential Group

SKT NO	KULLANILAN MODELLER Models	KULLANIM YERİ Place Of Use	ORJİNAL NO 1 Original No 1	ORJİNAL NO 2 Original No 2	EŞDEĞER NO 1 Equivalent No 1	EŞDEĞER NO 2 Equivalent No 2	ÖLÇÜLER - MM. Dimensions - MM.					TİP Type	MALZEME Material
410120-NK	CARGO - ESKİ MODEL 18000 SERİ.	MAHRUTİ (DİFER.ÖN) Differential - Front	-	-	-	-	66,67	116,03		12,70	22,22	SPL1K	NBR+YÜN- NW
410498-V	CARGO 3536-4136 6X4 =>2013 MERİTÖR DİFR.	MAHRUTİ (DİFER.ÖN) Differential - Front	6C464478AA	1524838	49364255	-	68,00	102,00		9,50	14,50	SPL3TLR SOL-Left	FKM
412289-V	CARGO 2520 (EATON 23000 SERİ DİFR.)	MAHRUTİ (DİFER.ÖN) Differential - Front	210724	-	01020451	-	74,60	128,00	143,00	12,50	27,50	SPL1LR SS-RL	FKM
412273-V	CARGO 2520 (EATON 23000 SERİ DİFR.)	MAHRUTİ (DİFER.ÖN) Differential - Front	C8HZ4676A	-	-	-	74,61	125,58	136,52	12,70	31,75	SPL1LL SS-RL	FKM
410364-V	CARGO 1814 22000 SERİ	MAHRUTİ (DİFER.ÖN) Differential - Front	-	-	12013643	UH0327E	76,20	114,43	120,65	10,90	19,05	SPL1LLR SS-RL	FKM
415161-VN	CARGO 2621-2626	MAHRUTİ (DİFER.ÖN) Differential - Front	A1205U1945	42531764	12006484	457.270	82,55	139,95	152,40	16,35	19,05	SPL3LL4 SS-RL	FKM+NBR
410488-V	CARGO 3536-4136-4142 (FUWA DİFR.)	ÖN DİFR. MAHRUTİ Front Differential	FC464231CA	FC464231CB	-	-	82,58	107,92		11	20,00	SC10	FKM
412388-V	CARGO 1846	MAHRUTİ (DİFER.ÖN) Differential - Front	FC464231BA	42534850	01031695	-	110,23	145,00		10,00	12,00	SPSC10	FKM
415249-V	CARGO 4142-4136 (FUWA DİFR.)	MAHRUTİ (DİFER.ÖN) Differential - Front	FC464231BA	21448461	12036895	-	90,00	151,00		11	18,00	SPSC10	FKM
047895-V	CARGO 3536-4136-4142 (FUWA DİFR.)	ÖN DİFR. ARKA ÇIKIŞ Differential Rear- Outer	FC464478AB	T227168	-	-	76,20	95,25		10,00	20,00	SC10	FKM
412381-V	CARGO 3536-4136-4142 (FUWA DİFR.)	ARKA DİFR. MAHRUTİ Diferantiel 4x4 Rear	FC464231AB	T259197	-	-	82,55	139,72		15,00	23,50	SPSC10	FKM

ŞANZİMAN GRUBU / Gearbox Group

SKT NO	KULLANILAN MODELLER Models	KULLANIM YERİ Place Of Use	ORJİNAL NO 1 Original No 1	ORJİNAL NO 2 Original No 2	EŞDEĞER NO 1 Equivalent No 1	EŞDEĞER NO 2 Equivalent No 2	ÖLÇÜLER - MM. Dimensions - MM.					TİP Type	MALZEME Material
045606-P	D 1210-1312HEMA 570 TİP	ŞANZİMAN ÖN Gearbox Front	-	-	-	-	39,69	60,50		9,52		L3	ACM
045763-P	CARGO - ESKİ MODELLER (TURNER ŞANZ.)	ŞANZİMAN ÖN Gearbox Front	CKE66957	900576	-	-	44,45	62,10		9,52		L3	ACM
045827-V	CARGO 2517-2520 EATON 4106-8209 - ZF 9S75	ŞANZİMAN ÖN Gearbox Front	X8870760	10101840	20016209	586.676	48,00	65,00		10,00		L13TL SAĞ -Right	FKM
047461	CARGO - ESKİ MODEL	ŞANZİMAN ÖN Gearbox Front	-	-	-	-	53,98	76,40		12,70		L3L	NBR

ŞANZİMAN GRUBU / Gearbox Group

SKT NO	KULLANILAN MODELLER Models	KULLANIM YERİ Place Of Use	ORJİNAL NO 1 Original No 1	ORJİNAL NO 2 Original No 2	EŞDEĞER NO 1 Equivalent No 1	EŞDEĞER NO 2 Equivalent No 2	ÖLÇÜLER - MM. Dimensions - MM.					TİP Type	MALZEME Material
045880-V	S6-85-F16	ŞANZİMAN ÖN İÇ Gearbox Front	6110376	-	12011306	284.662	48,00	69,00		10,00		L1 SAÇ-Right	FKM
046011	CARGO 2621 ZF 9S75 - 9S109 ŞANZ.	ŞANZİMAN ÖN Gearbox Front	0501311146	-	01017792	-	60,00	74,80		4,70		SPL5	NBR
047198	D 1210-1312	ŞANZİMAN ARKA Gearbox Rear	B9QH4813A-B-D	T7048A2	-	-	63,50	82,65		12,70		L1	NBR
047345	FORD 1210-1312	ŞANZİMAN ARKA Gearbox Rear	-	-	-	-	63,50	82,70		11,11		SLL	NBR
047552-P	D 1210-1312 HEMA 470 TİP	ŞANZİMAN ARKA Gearbox Rear	P25160	-	-	-	63,50	82,75		12,70		L3L SOL-Left	ACM
047647-V	CARGO 2517-2520-2621 EATON 4106	ŞANZİMAN ARKA Gearbox Rear	X13711	40100500	12014424	-	65,00	85,00		13,00	9,50	L13L SOL -Left	FKM
047563-P	D 1210-1312 HEMA 570 TİP	ŞANZİMAN ARKA Gearbox Rear	-	-	-	-	66,67	95,50		11,90		L3L SOL-Left	ACM
047645-V	CARGO 2621-2517-2520-2626 EAT.8209	ŞANZİMAN ARKA Gearbox Rear	9P907813A	-	12013860	034.347	78,00	100,00		10,00		L13TL SOL -Left	FKM
047650-V	CARGO 2621 ZF 9S75	ŞANZİMAN ARKA Gearbox Rear	0750111334	-	12013361	20027765	80,00	100,00		8,00		L3TL SOL -Left	FKM
047711-V	CARGO 2621 ZF 9S75	ŞANZİMAN ARKA Gearbox Rear	0750111334	-	01020467	587.966	80,00	100,00		10,00		L13TL SS-RL	FKM
410227	KAMYON SERİSİ	ŞANZİMAN ARKA Gearbox Rear	6110264	-	12011340	556.807	85,00	105,00		10,00		L1	NBR
410341-V	CARGO 2621-2517-2520-2626 EAT.8209	ŞANZİMAN ARKA Gearbox Rear	9P900924	-	-	-	90,00	110,00		12,00		L13TL SOL -Left	FKM
410376-V	CARGO 2626	ŞANZİMAN ARKA Gearbox Rear	0734319439	1262887	20029714	-	95,00	115,00		13,00		L13TL SOL -Left	FKM
410403-V	CARGO 2621 ZF 9S109-16S109 ŞANZ.	ŞANZİMAN ARKA Gearbox Rear	81965030220	1297604	01026691	-	105,00	125,00		12,00	9,50	L13TL SOL -Left	FKM
412386-V	FORD KARGO 1838-2538-3238 TELMA TİP.	RETARDER MİLİ Retarder Axle	BC462D292AA	-	-	-	90,00	130,00		9,50	16,00	SC10	FKM
040774-V	CARGO 2621 ZF 9S75	ŞANZİMAN KLM.ÇIKIŞ MİLİ Speedometer Shaft	0634300185	-	01002259	010.804	10,00	15,00		3,00		L5	FKM
040745	CARGO 2621-2626	ŞANZ. DEBRİYAJ KEÇESİ Clutch Shaft Seal	0634300302	-	12014616	-	25,00	35,00		7,00		L3TL	NBR
041177	CARGO 2621-2628 ZF 9S75-109 16S109	ŞANZ. DEBRİYAJ KEÇESİ Clutch Shaft Seal	0634300302	2961557	12014616	038.083	25,00	35,00		7,00		L13TL	NBR

ŞANZİMAN GRUBU / Gearbox Group

SKT NO	KULLANILAN MODELLER Models	KULLANIM YERİ Place Of Use	ORJİNAL NO 1 Original No 1	ORJİNAL NO 2 Original No 2	EŞDEĞER NO 1 Equivalent No 1	EŞDEĞER NO 2 Equivalent No 2	ÖLÇÜLER - MM. Dimensions - MM.				TİP Type	MALZEME Material	
4FM-112-CA	CARGO 2621 EATON 8209	ŞANZ. DEBRİYAJ KEÇESİ Clutch Shaft Seal	X8875532	-	-	-	65,00	70,00		2,10		L KARE	PTFE
041110-V	CARGO 2621-2626 ZF 9S109-16S109	ŞANZİMAN KULESİ Gearbox Tower	0750112047	699733	01029805	-	22,00	36,00	48,00	14,50		SPL3CTL	FKM
041111-V	CARGO 2621 SERİSİ ZF 9S75 ŞANZ.	ŞANZİMAN KULESİ Gearbox Tower	0501316333	-	01032393	-	22,00	36,00	57,00	14,50		SPL3CTL	FKM
4P-262-V	CARGO 3226-3227-2527-1830-1827-2527-2626 SER.	ŞANZİMAN PİSTON KEÇESİ Gearbox U Packing Seal	0750112089	-	504.540	5045400	53,00	63,00		16,20		PCX4	FKM
4P-260-H	ZF 9S75 ŞANZ.	TAKVİYE PİSTON KEÇESİ Reinforcement Piston Seal	0734309377	-	12014455	-	63,00	16,00		10,50		LS	HNBR

DİREKSİYON GRUBU / Steering Group

SKT NO	KULLANILAN MODELLER Models	KULLANIM YERİ Place Of Use	ORJİNAL NO 1 Original No 1	ORJİNAL NO 2 Original No 2	EŞDEĞER NO 1 Equivalent No 1	EŞDEĞER NO 2 Equivalent No 2	ÖLÇÜLER - MM. Dimensions - MM.				TİP Type	MALZEME Material	
041134	CARGO YENİ MODEL	DİREKSİYON KUTUSU Steering Box	-	-	-	-	19,05	34,60		6,20	9,20	L3BL	NBR
040037	1210-1312	DİREKSİYON KUTUSU Steering Box	622E3798	-	-	-	25,40	36,60		6,35		L5	NBR
041120	CARGO YENİ MODEL	DİREKSİYON KUTUSU Steering Box	0770196082	-	01019875	-	26,00	35,00		7,00		SPL3B	NBR
040743	CARGO 2014-2517-2520-2626 ZF TİP	DİREKSİYON KUTUSU Steering Box	0770196082	-	01019875	006.408	26,00	37,00		7,00	8,00	L3BTL	NBR
040744	CARGO 1312-1812-2114	DİREKSİYON KUTUSU Steering Box	-	-	237.744	-	28,00	40,00		7,00	8,00	L3BTL	NBR
045134	D 1210-1312	DİREKSİYON KUTUSU Steering Box	7K9201	-	-	-	38,10	50,90		6,35		L5	NBR
041159-V	D 1210-1312 ZF TİP POMPA	DİREKSİYON POMPA Steering Pump	0770 080 437	-	-	-	20,00	35,00	-	8,00	-	L13XT	FKM
045514	D 1210-1312	DİREK. SEKTÖR MİLİ Steering Sector Shaft	ZZL1121	200E3591	-	-	38,10	51,00		5,55		L3	NBR

MOTOR GRUBU / Engine Group

SKT NO	KULLANILAN MODELLER Models	KULLANIM YERİ Place Of Use	ORJİNAL NO 1 Original No 1	ORJİNAL NO 1 Original No 2	EŞDEĞER NO 1 Equivalent No 1	EŞDEĞER NO 1 Equivalent No 2	ÖLÇÜLER - MM. Dimensions - MM.					TİP Type	MALZEME Material
410491-VK	KOBRA OTOBÜS DEUTZ 1013 MOT.	KRANK ÖN Crank Shaft Front	04253373	7420412568	01027762	084.920	81,00	104,00		11,00		L13TL SAĞ -Right	FKM +YÜN-NW
412384-VAEK	KOBRA OTOBÜS DEUTZ 1013 MOT.	KRANK ARKA Crank Shaft Rear	20412286	04253333	01027763	NA5475	130,00	150,00		13,00		L3TL SOL -Left	FKM+ AEM +YÜN-NW
45-050-V	KOBRA OTOBÜS DEUTZ 1013 MOT.	SUPAP Valve Stem Seal	04179944	-	49472020	12015512	8,00	12,00	15,20	9,50		LSY2T	FKM

HINO

MOTOR GRUBU / Engine Group

SKT NO	KULLANILAN MODELLER Models	KULLANIM YERİ Place Of Use	ORJİNAL NO 1 Original No 1	ORJİNAL NO 1 Original No 2	EŞDEĞER NO 1 Equivalent No 1	EŞDEĞER NO 1 Equivalent No 2	ÖLÇÜLER - MM. Dimensions - MM.					TİP Type	MALZEME Material
045896-P	FB 112 KAMYON	KRANK ÖN Crank Shaft Front	982858104	-	HI-067	-	58,00	75,00		9,00	14,50	L3LR SAĞ -Right	ACM
410361-S	FB 112 KAMYON	KRANK ARKA Crank Shaft Rear	982800109	-	-	-	100,00	120,00		13,00	18,00	L3LR SOL -Left	VMQ
45-032-V	KAMYON-ÇEKİCİ J008 MOT.	SUPAP Valve Stem Seal	137191360	-	-	-	7,00	10,80	14,00	8,00	11,00	LSY	FKM
45-024-V	FB 112 KAMYON	SUPAP Valve Stem Seal	137191340	-	-	-	9,00	13,00	16,00	10,00	14,50	LSY	FKM

AKS GRUBU / Axle Group

SKT NO	KULLANILAN MODELLER Models	KULLANIM YERİ Place Of Use	ORJİNAL NO 1 Original No 1	ORJİNAL NO 1 Original No 2	EŞDEĞER NO 1 Equivalent No 1	EŞDEĞER NO 1 Equivalent No 2	ÖLÇÜLER - MM. Dimensions - MM.					TİP Type	MALZEME Material
047677	FB 112 KAMYON	ÖN AKS Front Axle	982885106	2310664900	-	-	84,00	100,00		10,00		LL1	NBR
412274	KAMYON-ÇEKİCİ TÜM MODELLER	ÖN AKS Front Axle	16865-T	-	-	-	88,90	132,15	120,00	13,00	25,00	SPSLL	NBR
040814	FB 112 KAMYON	ÖN AKS KİNG PİMİ Front Axle King Pin	982810102	-	-	-	35,00	41,00		4,50		LL5	NBR

AKS GRUBU / Axle Group

SKT NO	KULLANILAN MODELLER Models	KULLANIM YERİ Place Of Use	ORJİNAL NO 1 Original No 1	ORJİNAL NO 1 Original No 2	EŞDEĞER NO 1 Equivalent No 1	EŞDEĞER NO 1 Equivalent No 2	ÖLÇÜLER - MM. Dimensions - MM.					TİP Type	MALZEME Material
417118	KAMYON-ÇEKİCİ TÜM MODELLER	ARKA AKS Rear Axle	20964-T	-	-	-	133,35	187,60	161,31	9,60	25,40	SC	NBR
410357	FB 112 KAMYON	ARKA AKS DIŞ Rear Axle Outer	982857103	-	-	-	57,00	124,00		13,00	15,00	SPLL3	NBR
412284	FB 112 KAMYON	ARKA AKS İÇ Rear Axle Inner	982801203	-	-	-	127,00	147,00		11,00		LL1	NBR

DİFERANSİYEL GRUBU / Differential Group

SKT NO	KULLANILAN MODELLER Models	KULLANIM YERİ Place Of Use	ORJİNAL NO 1 Original No 1	ORJİNAL NO 1 Original No 2	EŞDEĞER NO 1 Equivalent No 1	EŞDEĞER NO 1 Equivalent No 2	ÖLÇÜLER - MM. Dimensions - MM.					TİP Type	MALZEME Material
410358-P	FB 112 KAMYON	MAHRUTİ (DİFER.ÖN) Differential - Front	982858109	-	-	-	58,00	102,00	87,70	8,00	22,00	SPSLLR SS-RL	ACM

ŞANZİMAN GRUBU / Gearbox Group

SKT NO	KULLANILAN MODELLER Models	KULLANIM YERİ Place Of Use	ORJİNAL NO 1 Original No 1	ORJİNAL NO 1 Original No 2	EŞDEĞER NO 1 Equivalent No 1	EŞDEĞER NO 1 Equivalent No 2	ÖLÇÜLER - MM. Dimensions - MM.					TİP Type	MALZEME Material
040813-P	FB 112 KAMYON	ŞANZİMAN ÖN Gearbox Front	982830101	-	-	-	30,00	42,00		8,00		L1L SAĞ -Right	ACM
045827-V	KAMYON-ÇEKİCİ ZF 9S75-109	ŞANZİMAN ÖN Gearbox Front	0750111149	699617	20016209	586.676	48,00	65,00		10,00		L13TL SAĞ -Right	FKM
046011	TÜM MODELLER ZF 9S75-109	ŞANZİMAN ÖN Gearbox Front	0501311146	-	01017792	-	60,00	74,80		4,70		SPL5	NBR
045897-P	FB 112 KAMYON	ŞANZİMAN ARKA Gearbox Rear	982847101	-	HI-066	-	48,00	65,00		9,00		L1L SOL-Left	ACM
047650-V	TÜM MOD. ZF 9S75-16S109	ŞANZİMAN ARKA Gearbox Rear	0750111334	-	01020467	587.966	80,00	100,00		8,00		L3TL SOL -Left	FKM
047711-V	TÜM MOD. ZF 9S75-16S109	ŞANZİMAN ARKA Gearbox Rear	0750111334	-	01020467	587.966	80,00	100,00		10,00		L13TL SS-RL	FKM

ŞANZIMAN GRUBU / Gearbox Group

SKT NO	KULLANILAN MODELLER Models	KULLANIM YERİ Place Of Use	ORJİNAL NO 1 Original No 1	ORJİNAL NO 2 Original No 2	EŞDEĞER NO 1 Equivalent No 1	EŞDEĞER NO 2 Equivalent No 2	ÖLÇÜLER - MM. Dimensions - MM.					TİP Type	MALZEME Material
410403-V	TÜM MOD. ZF 9S109-16S109	ŞANZIMAN ARKA Gearbox Rear	0734319459	-	01026691	-	105,00	125,00		12,00	9,50	L13TL SOL -Left	FKM
040774-V	TÜM MODELLER ZF 9S75	ŞANZIMAN KLM.ÇIKIŞ MİLİ Speedometer Shaft	0634300185	-	01002259	010.804	10,00	15,00		3,00		L5	FKM
040745	TÜM MODELLER	ŞANZ. DEBRİYAJ KEÇESİ Clutch Shaft Seal	0634300302	-	12011122	038.705	25,00	35,00		7,00		L3TL	NBR
041177	TÜM MOD. ZF 9S75-109-16S109	ŞANZ. DEBRİYAJ KEÇESİ Clutch Shaft Seal	0634300302	140335	12014616	12010846	25,00	35,00		7,00		L13TL	NBR
041110-V	TÜM MOD. ZF 9S109-16S109	ŞANZIMAN KULESİ Gearbox Tower	0750112047	-	01029805	-	22,00	36,00	48,00	14,50		SPL23CTL	FKM
041111-V	TÜM MODELLER ZF 9S75	ŞANZIMAN KULESİ Gearbox Tower	0501316333	-	01032393	-	22,00	36,00	57,00	14,50		SPL3CTL	FKM
4P-260-H	ZF 9S75 ŞANZ.	TAKVİYE PİSTON KEÇESİ Reinforcement Piston Seal	0734309379	-	12014457	-	63,00	16,00		10,50		LS	HNBR

MOTOR GRUBU / Engine Group

SKT NO	KULLANILAN MODELLER Models	KULLANIM YERİ Place Of Use	ORJİNAL NO 1 Original No 1	ORJİNAL NO 2 Original No 2	EŞDEĞER NO 1 Equivalent No 1	EŞDEĞER NO 2 Equivalent No 2	ÖLÇÜLER - MM. Dimensions - MM.					TİP Type	MALZEME Material
045761-P	NKR	KRANK ÖN Crank Shaft Front	2509625079001	8970491450	19033958	933.180	50,00	68,00		9,00		L3L SAĞ -Right	ACM
046239-VK	2.2 MOT. TERMOKİNG MOT.	KRANK ÖN Crank Shaft Front	8970491450	10332881	19033958	-	50,00	68,00		9,00		SPL3K SAĞ -Right	FKM +YÜN-NW
047614-P	NPR-KS22-MD27	KRANK ÖN Crank Shaft Front	2894373765001	5096250150	15029600	-	60,00	82,00		12,00		L3L SAĞ -Right	ACM
412310-V	NPR 66-MD27-NQR	KRANK ÖN Crank Shaft Front	2897329780051	8943695180	811062100	-	109,00	137,00		15,50		SPL13LR	FKM
410499-VK	2.2 MOT. TERMOKİNG MOT.	KRANK ARKA Crank Shaft Rear	8970715611	-	19019103	BZ4962E	95,00	118,00		9,50	13,00	SC ETS1	FKM +YÜN-NW
410317-S	NKR	KRANK ARKA Crank Shaft Rear	2894235369001	8942353690	19019210	NJ322	95,00	118,00		10,00		L3L SOL-Left	VMQ
412247-S	NPR-KS22-MD27	KRANK ARKA Crank Shaft Rear	2894107568001	-	-	-	100,00	135,00		10,00		L3L SOL-Left	VMQ
412242-S	NPR-KS22-MD27	KRANK ARKA Crank Shaft Rear	2509625052001	-	-	-	100,00	135,00	140,00	14,00	15,00	SPL3L SOL -Left	VMQ
412311-V	NPR 66-MD27-NQR	KRANK ARKA Crank Shaft Rear	2897602379051	-	-	-	104,00	139,00	0,00	15,50		SPL13LR	FKM
45-020-V	NKR	SUPAP Valve Stem Seal	2512569006001	-	-	-	7,90	12,80	15,50	11,00	16,50	LSY	FKM
45-019-P	NPR-KS22-MD27	SUPAP Valve Stem Seal	2512569001001	-	-	-	8,90	14,00	17,50	12,00	17,20	LSY	ACM
040726	NPR-KS22-MD27	YAKIT GAZ KOLU Fuel Lever	2515729019001	-	-	-	10,00	20,00		4,00		L3	NBR
040725	NPR-KS22-MD27	SARJ DİNAMOSU Charger Shaft	28941565890051	-	-	-	15,00	32,00		7,50		SPL3L	NBR
040725-V	NKR-NPR KAMYON SERİLERİ	ŞARJ DİNAMOSU Charger Shaft	-	-	-	-	15,00	32,00		7,50		SPL3BL	FKM

AKS GRUBU / Axle Group

SKT NO	KULLANILAN MODELLER Models	KULLANIM YERİ Place Of Use	ORJİNAL NO 1 Original No 1	ORJİNAL NO 2 Original No 2	EŞDEĞER NO 1 Equivalent No 1	EŞDEĞER NO 2 Equivalent No 2	ÖLÇÜLER - MM. Dimensions - MM.					TİP Type	MALZEME Material
047581	KS22	ÖN AKS Front Axle	2509625029001	-	-	-	70,00	90,00		10,00		SLL	NBR

AKS GRUBU / Axle Group

SKT NO	KULLANILAN MODELLER Models	KULLANIM YERİ Place Of Use	ORJİNAL NO 1 Original No 1	ORJİNAL NO 1 Original No 2	EŞDEĞER NO 1 Equivalent No 1	EŞDEĞER NO 1 Equivalent No 2	ÖLÇÜLER - MM. Dimensions - MM.					TİP Type	MALZEME Material
047574	NKR-NPR66-KS22-MD27-NQR	ÖN AKS Front Axle	2894248117101	894248117101	-	-	73,00	90,00		8,00	8,40	L1CL	NBR
047596	NKR	ARKA AKS PORYA DIŞ Rear Axle Outer	2894258894001	-	-	-	46,00	94,50		8,00	9,50	SPL2	NBR
047583	NKR-NPR-KS22-MD27	ARKA AKS PORYA DIŞ Rear Axle Outer	2894101493001	-	-	-	49,17	100,00		8,00	9,50	SPL2	NBR
047662	NPR 66	ARKA AKS PORYA DIŞ Rear Axle Outer	2894336317101	894336317101	-	-	49,17	100,00		8,00	9,80	SPL3 SS-RL	NBR
410387	NPR-NQR	ARKA AKS PORYA DIŞ Rear Axle Outer	897122937051	-	-	-	82,00	121,00	100,00	12,00	20,00	SPSLLL	NBR
410316	NKR	ARKA AKS PORYA İÇ Rear Axle Inner	2509625030001	-	-	-	77,00	102,00	93,00	10,00	19,00	SPLSL	NBR
410308	NPR-KS22-MD27	ARKA AKS PORYA İÇ Rear Axle Inner	2909724018001	-	-	-	80,17	113,00	98,00	12,00	22,00	SPLSL	NBR
410352	NPR 59-66	ARKA AKS PORYA İÇ Rear Axle Inner	2894336316001	894336316001	-	-	80,17	113,00	98,00	12,00	20,50	SPSLLL	NBR

DİFERANSİYEL GRUBU / Differential Group

SKT NO	KULLANILAN MODELLER Models	KULLANIM YERİ Place Of Use	ORJİNAL NO 1 Original No 1	ORJİNAL NO 1 Original No 2	EŞDEĞER NO 1 Equivalent No 1	EŞDEĞER NO 1 Equivalent No 2	ÖLÇÜLER - MM. Dimensions - MM.					TİP Type	MALZEME Material
410307-P	NPR-KS22-MD27	MAHRUTİ (DİFER.ÖN) Differential - Front	2909724010001	-	-	-	58,00	103,00		12,00	19,00	LL3R	ACM

ŞANZİMAN GRUBU / Gearbox Group

SKT NO	KULLANILAN MODELLER Models	KULLANIM YERİ Place Of Use	ORJİNAL NO 1 Original No 1	ORJİNAL NO 1 Original No 2	EŞDEĞER NO 1 Equivalent No 1	EŞDEĞER NO 1 Equivalent No 2	ÖLÇÜLER - MM. Dimensions - MM.					TİP Type	MALZEME Material
040631-P	NKR-NPR-KS22-MD27	ŞANZİMAN ÖN Gearbox Front	2509625018001	8943264410	19016656	-	27,00	43,00		9,00		L3L	ACM

ŞANZIMAN GRUBU / Gearbox Group

SKT NO	KULLANILAN MODELLER Models	KULLANIM YERİ Place Of Use	ORJİNAL NO 1 Original No 1	ORJİNAL NO 1 Original No 2	EŞDEĞER NO 1 Equivalent No 1	EŞDEĞER NO 1 Equivalent No 2	ÖLÇÜLER - MM. Dimensions - MM.					TİP Type	MALZEME Material
045739-P	NKR-NPR-KS22-MD27-NKR	ŞANZIMAN ARKA Gearbox Rear	2909724007001	-	-	-	45,00	65,00		10,00	12,00	L1L	ACM
047582	KS22	ŞANZIMAN MİLİ Gearbox Axle	2509625006701	-	-	-	50,00	67,00	79,00	14,00		SPL5L	NBR

DİĞER ÜRÜNLER / Other Parts

SKT NO	KULLANILAN MODELLER Models	KULLANIM YERİ Place Of Use	ORJİNAL NO 1 Original No 1	ORJİNAL NO 1 Original No 2	EŞDEĞER NO 1 Equivalent No 1	EŞDEĞER NO 1 Equivalent No 2	ÖLÇÜLER - MM. Dimensions - MM.					TİP Type	MALZEME Material
4P-258	MİDİBÜS SERİSİ	HAVALI KAPI PİSTONU Air Door System	-	-	-	-	18,00	60,00		26,50		PCXY	NBR

MOTOR GRUBU / Engine Group

SKT NO	KULLANILAN MODELLER Models	KULLANIM YERİ Place Of Use	ORJİNAL NO 1 Original No 1	ORJİNAL NO 2 Original No 2	EŞDEĞER NO 1 Equivalent No 1	EŞDEĞER NO 2 Equivalent No 2	ÖLÇÜLER - MM. Dimensions - MM.					TİP Type	MALZEME Material
045241	642	KRANK ÖN Crank Shaft Front	55496	-	12010936	330.809	40,00	62,00		10,00		L3	NBR
045850-V	EUROCARGO-85-100-130-150-50NC	KRANK ÖN Crank Shaft Front	99469265	98461684	12014859	071.550	42,00	65,00		10,00		L13TL SAĞ -Right	FKM
045537-S	50 NC-75.12-80.12-85.12 - 85.14-M23-24-29-50-35.9	KRANK ÖN Crank Shaft Front	40000010	40101330	12013479	12011460	42,00	65,00		12,00		L1L SAĞ -Right	VMQ
045537-V	50 NC-75.12-80.12-85.12 - 85.14-M23-24-29-50-35.9	KRANK ÖN Crank Shaft Front	40101330	40000010	12013479	12011460	42,00	65,00		12,00		L1L SAĞ -Right	FKM
046145-V	50 NC	KRANK ÖN Crank Shaft Front	40101330	40000010	12013479	12011460	42,00	65,00		12,00		L13TL SAĞ -Right	FKM
047811-V	EURO STAR/TECH 440 SERİSİ	KRANK ÖN Crank Shaft Front	98467211	98494984	12031043	763.144	70,00	90,00		10,00		L13TL SAĞ -Right	FKM
410471-FPK	KAMYON-CEKİCİ SERİSİ	KRANK ÖN Crank Shaft Front	42537150	5010550791	20029789	243.550	90,00	120,00	-	13,00	-	F25TL SAĞ -Right	PTFE+ACM +YÜN-NW
412387-VK	STRALIS-TRAKKER-CURSOR 13 F3BE MOT.	KRANK ÖN Crank Shaft Front	40102680	40102683	12029819	457260	100,00	130,00		14,00		SC ETS1	FKM +YÜN-NW
412275-V	EUROTECH-190-440E SERİSİ	KRANK ÖN Crank Shaft Front	8198823	42492379	01016267	524.973	105,00	130,00		12,00		L13L SAĞ -Right	FKM
410219-V	50 NC	KRANK ARKA Crank Shaft Rear	40000720	4600765	12011314	071.570	95,00	120,00		13,00		L1L SOL-Left	FKM
412176-S	50 NC	KRANK ARKA Crank Shaft Rear	40002811	40002810	12011317	422.320	110,00	135,00		13,00		L1L SOL-Left	VMQ
412235-V	50 NC-75.12-80.12-85.12 85.14-M23-24-29-50-35.9	KRANK ARKA Crank Shaft Rear	40003800	40101341	12011318	12016274	114,00	135,00		13,00		L1L SOL-Left	FKM
412281-V	EUROCARGO-85-100-130-150-50NC	KRANK ARKA Crank Shaft Rear	40003800	40101340	12014858	12016274	114,00	135,00		13,00		L13TL SOL -Left	FKM
412357-FP	EUROTECH-EUROSTAR-400-440 (ALT.)	KRANK ARKA Crank Shaft Rear	40101470	40101220	20029785	445.600	115,00	140,00		13,00		F25TL SOL -Left	PTFE+ACM
412276-V	EUROTECH-190-440E SERİSİ	KRANK ARKA Crank Shaft Rear	40003010	-	12014877	562.920	120,00	140,00		13,00		L13L SOL -Left	FKM
415236-VK	STRALIS-TRAKKER-EUROSTAR-EURO-TECH 13 F3BE MOT.	KRANK ARKA Crank Shaft Rear	40102690	504244493	12029820	454.050	130,00	160,00		14,00		SC ETS1	FKM +YÜN-NW
415208-V	EUROTECH-EUROSTAR-400-440	KRANK ARKA Crank Shaft Rear	98494987	98467213	12031045	811011800	140,00	165,00		13,00		L13TL SOL -Left	FKM
415108-S	190-697-330	KRANK ARKA Crank Shaft Rear	40000740	40100600	12011323	-	140,00	165,00		15,00		L1L SOL-Left	VMQ

MOTOR GRUBU / Engine Group

SKT NO	KULLANILAN MODELLER Models	KULLANIM YERİ Place Of Use	ORJİNAL NO 1 Original No 1	ORJİNAL NO 2 Original No 2	EŞDEĞER NO 1 Equivalent No 1	EŞDEĞER NO 2 Equivalent No 2	ÖLÇÜLER - MM. Dimensions - MM.					TİP Type	MALZEME Material
417126-FPK	KAMYON-CEKİCİ SERİSİ	KRANK ARKA Crank Shaft Rear	42537151	-	20029788	233.530	160,00	190,00	-	13,00	-	F25TL SOL -Left	PTFE+ACM +YÜN-NW
45-030-V	STRALIS-440	SUPAP Valve Stem Seal	40101573	4749394	12015512	104.380	8,00	12,00	15,20	9,50		LSY2T	FKM
040281	650-50NC	YAKIT POMPASI Fuel Pump	79023584	9982785	12015322	-	17,00	28,00		7,00		L1	NBR
040592	EUROCARGO-100-130-150	YAKIT POMPASI Fuel Pump	79045965	-	12001623	-	20,00	30,00		7,00		L3L	NBR
040760	EUROCARGO-85-100-130-150	YAKIT POMPASI Fuel Pump	79071380	-	12014600	-	20,00	31,00		7,00		L1B	NBR
040942-V	EUROCARGO-150	YAKIT POMPASI Fuel Pump	42530258	42551388	12019586	-	20,00	31,00		7,30		L13TL	FKM
045372	682	YAKIT POMPASI Fuel Pump	10043490	-	12010860	12011126	25,00	52,00	-	7,00	-	L3	NBR
040850	EUROSTAR-EUROTECH-400-440-BOSCH	YAKIT POMPASI Fuel Pump	8194388	-	01001681	11014231	30,00	42,00		6,00	6,50	L3BTL	NBR
045504	643	YAKIT POMPASI Fuel Pump	-	-	-	-	32,00	62,00		10,00		L3	NBR
040180	643	REGÜLATÖR MİLİ Regulator Shaft	759371	-	12010826	12011118	20,00	40,00		7,00		L3	NBR
040084	644	SU POMPASI Water Pump	25450612	-	12010828	12012842	20,00	42,00		7,00		L3	NBR
040250	642	SU POMPASI Water Pump	4026520	-	-	-	22,00	45,00		7,00		L3	NBR
045153	642	SU POMPASI Water Pump	10014290	-	-	-	28,00	52,00		10,00		L3	NBR
040450	50 NC	HAVA KOMPRESÖRÜ Air Compressor	40000560	40002280	12011665	-	25,00	47,00		10,00		L1L	NBR
041049-V	50 NC-75.-80-85-85-M23-24-29-50-35.9 EUROCARGO 85-100	HAVA KOMPRESÖRÜ Air Compressor	79043163	42551646	12011676	797IFL	28,00	47,00		7,00		L3 SS-RL	FKM
040922-V	EUROCARGO/STAR/TECH-85-100-130-150- 400-440 BENDİX	HAVA KOMPRESÖRÜ Air Compressor	7980955	1307817	12001192	15000581	30,00	47,00		7,00		L3	FKM

AKS GRUBU / Axle Group

SKT NO	KULLANILAN MODELLER Models	KULLANIM YERİ Place Of Use	ORJİNAL NO 1 Original No 1	ORJİNAL NO 2 Original No 2	EŞDEĞER NO 1 Equivalent No 1	EŞDEĞER NO 2 Equivalent No 2	ÖLÇÜLER - MM. Dimensions - MM.					TİP Type	MALZEME Material
047852-VN	EUROCARGO-EURO STAR-STRALIS SERİSİ	ÖN AKS Front Axle	40102293	40102290	12015928	-	65,00	90,00	-	13,00	14,50	SC65S-RL	FKM+NBR
047810-VN	EURO CARGO 120 SERİSİ	ÖN AKS Front Axle	40102833	40102830	12016648	-	67,00	100,00		13,00	15,00	SCL13TL SS-RL	FKM+NBR
047648-P	EUROCARGO-85-100	ÖN AKS Front Axle	40100483	40100480	12014289	-	70,00	90,00		12,00		L1L SS-RL	ACM
047544	50 NC	ÖN AKS Front Axle	80220021	80384548	12011203	-	75,00	100,00		10,00		L3L	NBR
047520	50 NC	ÖN AKS Front Axle	40001883	8836666	12011411	13197P	75,00	100,00		13,00		SLL	NBR
047520-P	50 NC-75.12-80.12-85.12- 85.14-M23-24-29-50-35.9	ÖN AKS Front Axle	40001883	40001880	12011411	13197P	75,00	100,00		13,00		SLL	ACM
412312-VN	TÜM MODELLER-85-100-150-400-440- 250E21	ÖN AKS Front Axle	40102143	40102140	12015509	454.000	95,00	130,00		16,00		SCL13TL SS-RL	FKM+NBR
410121	650 E	ÖN AKS Front Axle	974123	-	12011047	-	100,00	120,00		12,00		L3	NBR
412196	643 E	ÖN AKS Front Axle	40001030	4551424	12011364	12017368	110,00	130,00		13,00		L1L	NBR
412159	190-330	ÖN AKS Front Axle	40001930	40001933	12011419	022.560	125,00	150,00		13,00		L1L	NBR
415084	697-330	ÖN AKS Front Axle	40000480	-	12011373	-	145,00	170,00		13,00		L1L	NBR
417031	697-331	ÖN AKS Front Axle	8527970	-	12011091	109.657	150,00	180,00		13,00		L3	NBR
040534	50 NC-75.12-80.12-85.12- 85.14-M23-24-29-50-35.9	ÖN AKS KİNG PİMİ Front Axle King Pin	7163000	7170630	12001732	-	27,00	33,70		4,00		L5	NBR
040970	75.12-80.12-85.12-85.14-M23-24-29-50	ÖN AKS KİNG PİMİ Front Axle King Pin	40101041	-	01030541	-	28,00	35,00		5,00		L5	NBR
040535	75.12-80.12-85.12-85.14-M23-24-29-50-35.9	ÖN AKS ALT PİMİ Front Axle King Pim	7162882	-	12006465	-	34,00	41,20		3,50	5,70	L5R	NBR
040971	75.12-80.12-85.12-85.14-M23-35.9	ÖN AKS KİNG PİMİ Front Axle King Pin	40101051	-	-	-	35,00	42,00		3,50	5,70	L5R	NBR
410442-PN	EUROCARGO-100	ARKA AKS Rear Axle	7984661	7149488	12006485	-	63,50	98,45	108,00	15,00	17,90	SC	ACM+NBR
410053	35NC-50 NC	ARKA AKS Rear Axle	540727	-	12011031	-	80,00	110,00		13,00		L3	NBR

AKS GRUBU / Axle Group

SKT NO	KULLANILAN MODELLER Models	KULLANIM YERİ Place Of Use	ORJİNAL NO 1 Original No 1	ORJİNAL NO 2 Original No 2	EŞDEĞER NO 1 Equivalent No 1	EŞDEĞER NO 2 Equivalent No 2	ÖLÇÜLER - MM. Dimensions - MM.					TİP Type	MALZEME Material
410228	50 NC	ARKA AKS Rear Axle	40001590	40001670	12011358	13129PIAC	80,00	110,00		13,00		L1L	NBR
410265	50 NC-75.12-80.12-85.12- 85.14-M23-24-29-50-35.9	ARKA AKS Rear Axle	40001903	40001900	12011412	01032790	90,00	110,00		13,00		SLL	NBR
410265-P	50 NC-75.12-80.12-85.12- 85.14-M23-24-29-50-35.9	ARKA AKS Rear Axle	40001903	40001900	12011412	13454P	90,00	110,00		13,00		SLL	ACM
410265-V	190	ARKA AKS Rear Axle	40001903	40001900	12011412	12002888	90,00	110,00		13,00		SLL	FKM
410265-V	50 NC-75.12-80.12-85.12- 85.14-M23-24-29-50-35.9	ARKA AKS Rear Axle	40001903	40001900	12011412	13454P	90,00	110,00		13,00		SLL	FKM
412361-VN	EUROBUS SERİSİ	ARKA AKS Rear Axle	830417	0Y983859	-	-	98,40	144,50		16,50		SC	FKM+NBR
412195	697 N	ARKA AKS Rear Axle	TA1118	-	-	-	107,72	146,05		12,70		CL3	NBR
412170	KAMYON	ARKA AKS Rear Axle	2475845	4459071	12012064	042.935	120,00	140,00		13,00		L1L	NBR
415239-V	ZF AKSLI MODELLER	ARKA AKS Rear Axle	42548295	93163213	12019945	-	130,00	170,00		18,00	20,00	SC12	FKM
415223-V	TGA-TGM-L SERİSİ	ARKA AKS Rear Axle	42554907	-	12020156	485.890	132,00	160,00		10,00		L1	FKM
417114	190-330	ARKA AKS Rear Axle	40101540	41296800	-	-	166,00	186,00		15,00	23,00	L3TLLR	NBR
417091	EUROTECH-EUROSTAR-400-440-190-330	ARKA AKS Rear Axle	40100443	40100439	12012049	348.376	180,00	200,00		12,00		L3L	NBR
417045	EUROTECH-EUROSTAR-400-440 - 190-697 MOD.	ARKA AKS Rear Axle	7163592	40000690	12011379	-	180,00	200,00		15,00		L1L	NBR
047189	642 SERİSİ	ARKA AKS DIŞ Rear Axle Outer	14536	-	-	-	65,00	90,00		12,00		L3	NBR
047104	682 N SERİSİ	ARKA AKS DIŞ Rear Axle Outer	38510549	843075	12011021	530.107	75,00	100,00		10,00		L3	NBR
412149	650 E	ARKA AKS DIŞ Rear Axle Outer	40001060	4566052	12011347	-	118,00	136,00		13,00		L1	NBR
415054	643 E	ARKA AKS DIŞ Rear Axle Outer	4560719	-	12011349	255.637	140,00	160,00		13,00		L3	NBR
415078	643 E	ARKA AKS DIŞ Rear Axle Outer	4560719	-	12011349	255.637	140,00	160,00		13,00		L1	NBR

AKS GRUBU / Axle Group

SKT NO	KULLANILAN MODELLER Models	KULLANIM YERİ Place Of Use	ORJİNAL NO 1 Original No 1	ORJİNAL NO 2 Original No 2	EŞDEĞER NO 1 Equivalent No 1	EŞDEĞER NO 2 Equivalent No 2	ÖLÇÜLER - MM. Dimensions - MM.					TİP Type	MALZEME Material
415128-P	190-643	ARKA AKS DIŞ Rear Axle Outer	40000950	4573796	12011278	-	150,00	168,00		13,00		L1	ACM
417109	EURO TECH/STAR 440 SERISI	ARKA AKS DIŞ Rear Axle Outer	40101733	40101730	12015265	453.990	180,00	200,00		17,00		SL13TLL SS-RL	NBR
417109-V	EURO TECH/STAR 400-440 SERISI	ARKA AKS DIŞ Rear Axle Outer	40101733	40101730	12015265	453.990	180,00	200,00		17,00		SL13TLL SS-RL	FKM
415006	682 N	ARKA AKS İÇ Rear Axle Inner	28431822	381856	12011082	-	130,00	160,00		12,00		L3	NBR
417041	643 E-684	ARKA AKS İÇ Rear Axle Inner	4580400	38529750	12011376	-	160,00	185,00		13,00		L1L	NBR
045650	697	ARKA AKS KOVAN İÇ Rear Axle	40000390	-	-	-	42,00	64,00		12,00	16,00	SPSL	NBR
4D-406-S	IVECO YENİ MOD.(ROCKWELL SIMP. 410)	FREN MİLİ Brake Pad Dust Seal	42531677	42531677	-	-	14,70	42,90	53,00	28,00		D	VMQ
4D-410-S	IVECO YENİ MOD.(ROCKWELL 410)	FREN MİLİ Brake Pad Dust Seal	42537841	1205E2683	-	-	25,00	47,85		11,70		D	VMQ

DİFERANSİYEL GRUBU / Differential Group

SKT NO	KULLANILAN MODELLER Models	KULLANIM YERİ Place Of Use	ORJİNAL NO 1 Original No 1	ORJİNAL NO 2 Original No 2	EŞDEĞER NO 1 Equivalent No 1	EŞDEĞER NO 2 Equivalent No 2	ÖLÇÜLER - MM. Dimensions - MM.					TİP Type	MALZEME Material
047199	50 NC	MAHRUTİ (DİFER.ÖN) Differential - Front	543637	90407400	12010974	01029597	50,00	80,00		13,00		L3	NBR
047576	75.12-80.12-85.12-M23-24-29-50-35.9	MAHRUTİ (DİFER.ÖN) Differential - Front	40003710	40003713	12011432	13502PAC	50,00	81,00		13,00		L3L	NBR
047655-P	50 NC-75.12-80.12-85.12- 85.14-M23-24-29-50-35.9	MAHRUTİ (DİFER.ÖN) Differential - Front	40003713	40003710	12011432	13502PAC	50,00	81,00		13,00		L1L	ACM
047655-V	50 NC-75.12-80.12-85.12- 85.14-M23-24-29-50-35.9	MAHRUTİ (DİFER.ÖN) Differential - Front	40003713	40003710	12011432	13502PAC	50,00	81,00		13,00		L1L	FKM
047237	642 SERISI	MAHRUTİ (DİFER.ÖN) Differential - Front	555076	-	12011003	-	62,00	85,00		10,00		L3	NBR
410173	643 E	MAHRUTİ (DİFER.ÖN) Differential - Front	4545571	40000750	12011283	-	70,00	112,00		12,00		L1	NBR
410046	642	MAHRUTİ (DİFER.ÖN) Differential - Front	862273	-	-	-	75,00	112,00		12,00		L3	NBR

DİFERANSİYEL GRUBU / Differential Group

SKT NO	KULLANILAN MODELLER Models	KULLANIM YERİ Place Of Use	ORJİNAL NO 1 Original No 1	ORJİNAL NO 2 Original No 2	EŞDEĞER NO 1 Equivalent No 1	EŞDEĞER NO 2 Equivalent No 2	ÖLÇÜLER - MM. Dimensions - MM.					TİP Type	MALZEME Material
412334-PN	TECTOR	MAHRUTİ (DİFER.ÖN) Differential - Front	-	-	-	-	75,50	126,00	135,00	19,50	-	SPSC SS-RL	ACM+NBR
410364-V	EUROCARGO-130-150	MAHRUTİ (DİFER.ÖN) Differential - Front	93160191	93193136	12013643	UH0327E	76,20	114,43	120,65	10,90	19,05	SPL1LLR SS-RL	FKM
410319-P	190	MAHRUTİ (DİFER.ÖN) Differential - Front	40002160	40000620	12011302	-	80,00	110,00		13,00		L1L SAĞ -Right	ACM
415161-VN	EUROTECH-EUROSTAR-400-440	MAHRUTİ (DİFER.ÖN) Differential - Front	7984287	42531764	12006484	457.270	82,61	139,70		16,50	19,40	SPL3LL4 SS-RL	FKM+NBR
410489-V	-	MAHRUTİ (DİFER.ÖN) Differential - Front	42534214	-	01029710	-	90,00	125,00		12,00	19,00	L3TLR SAĞ -Right	FKM
415191-V	FH12-FH16	MAHRUTİ (DİFER.ÖN) Differential - Front	42554790	-	01016886	435.990	90,00	151,00		10,00	15,00	L13TLR SAĞ -Right	FKM
412388-V	EUROSTAR-EUROTECH-STRALIS-EUROTECH	MAHRUTİ (DİFER.ÖN) Differential - Front	42534850	42538856	01031695	-	110,23	145,00		10,00	12,00	SPSC10	FKM

ŞANZİMAN GRUBU / Gearbox Group

SKT NO	KULLANILAN MODELLER Models	KULLANIM YERİ Place Of Use	ORJİNAL NO 1 Original No 1	ORJİNAL NO 2 Original No 2	EŞDEĞER NO 1 Equivalent No 1	EŞDEĞER NO 2 Equivalent No 2	ÖLÇÜLER - MM. Dimensions - MM.					TİP Type	MALZEME Material
041050-P	KAMYON-ÇEKİCİ	ŞANZİMAN ÖN Gearbox Front	40100791	-	12012768	-	30,00	47,00	-	8,00	-	L1L	ACM
045329	50 NC	ŞANZİMAN ÖN Gearbox Front	595985	40002510	12011496	13072AC	35,00	55,00		10,00		L1	NBR
045329-P	50 NC-75.12-80.12-85.12- 85.14-M23-24-29-50-35.9	ŞANZİMAN ÖN Gearbox Front	595985	10015690	12011496	13072AC	35,00	55,00		10,00		L1	ACM
046087-V	MASCOT 5S 200/270	ŞANZİMAN ÖN Gearbox Front	40102760	40102763	12029812	-	35,00	64,00		9,00		L13TL SAĞ -Right	FKM
045606-P	75.12-80.12-85.12-M23-24-29-50-35.9	ŞANZİMAN ÖN Gearbox Front	X10889	37H4667	-	-	39,69	60,50		9,52		L3	ACM
045505	643	ŞANZİMAN ÖN Gearbox Front	815835	4044664	12010946	040.355	42,00	62,00	-	10,00	-	L3	NBR
045149	642	ŞANZİMAN ÖN Gearbox Front	28106922	3345907	12011168	-	45,00	65,00		10,00		L3	NBR
046081-V	75.12-80.12-85.12-M23-24-29-50-35.9	ŞANZİMAN ÖN Gearbox Front	40100513	40100510	12012045	586.676	48,00	65,00		6,90	10,00	SPL13TL SAĞ-Right	FKM

ŞANZIMAN GRUBU / Gearbox Group

SKT NO	KULLANILAN MODELLER Models	KULLANIM YERİ Place Of Use	ORJİNAL NO 1 Original No 1	ORJİNAL NO 2 Original No 2	EŞDEĞER NO 1 Equivalent No 1	EŞDEĞER NO 2 Equivalent No 2	ÖLÇÜLER - MM. Dimensions - MM.					TİP Type	MALZEME Material
045827-V	EUROCARGO-STRALIS-85-100-130-150/9S75-16S 109	ŞANZIMAN ÖN Gearbox Front	40100513	8193021	20016209	586.676	48,00	65,00		10,00		L13TL SAĞ -Right	FKM
045840-V	190 SERİSİ	ŞANZIMAN ÖN Gearbox Front	42480940	42485652	12011307	033.472	48,00	75,00		8,00		L1 SAĞ-Right	FKM
045964-V	ZF 16S151	ŞANZIMAN ÖN Gearbox Front	42484086	-	12018806	141.960	52,00	68,00		8,00		L13TL SAĞ -Right	FKM
047196	650 E	ŞANZIMAN ÖN Gearbox Front	40958	-	-	-	54,00	82,00		11,00		L3	NBR
045990-V	EUROTECH-STARALIS-440 12AS2301	ŞANZIMAN ÖN Gearbox Front	42531636	40003650	12015120	NP067	55,00	70,00		8,00		L13TL SAĞ -Right	FKM
045851-V	EUROSTAR-EUROTECH-STRALIS-400-440 ZF 16S221-151-181	ŞANZIMAN ÖN Gearbox Front	42533218	7982064	12011308	284.645	55,00	75,00		8,00		L1 SAĞ-Right	FKM
046115-P	STRALIS-440-16S-151 2. SERİ	ŞANZIMAN ÖN Gearbox Front	42545936	-	01031969	515.340	55,00	75,00		8,00	9,20	L1R SAĞ -Right	ACM
047591-P	190 - EUROTECH/EUROSTAR 440	ŞANZIMAN ÖN Gearbox Front	40000520	42486609	12011282	446.602	55,00	80,00		10,00		L1L	ACM
045880-V	S6-85-F16	ŞANZIMAN ÖN İÇ Gearbox Front	42487486	9933054	12011306	284.662	48,00	69,00		10,00		L1 SAĞ-Right	FKM
046011	ZF 9S75 - 9S109 ŞANZ.	ŞANZIMAN ÖN Gearbox Front	0501311146	-	01017792	-	60,00	74,80		4,70		SPL5	NBR
046086-V	-	ŞANZIMAN ARKA Gearbox Rear	40102770	40102773	12029813	-	40,00	52,00		9,00		L3TL SOL -Left	FKM
047554-P	75.12-80.12-85.12-85.14-M23-24-29-50-35.9	ŞANZIMAN ARKA Gearbox Rear	X13072	-	-	-	53,98	76,40		9,52		L3L SOL-Left	ACM
047591	50 NC	ŞANZIMAN ARKA Gearbox Rear	40000520	42486609	12011282	-	55,00	80,00		10,00		L1L	NBR
047591-P	50 NC-75.12-80.12-85.12-85.14-M23-24-29-50-35.9	ŞANZIMAN ARKA Gearbox Rear	40000520	42486609	12011282	446.602	55,00	80,00		10,00		L1L	ACM
047101	642	ŞANZIMAN ARKA Gearbox Rear	4655211	741605	12010988	-	55,00	90,00		10,00		L3	NBR
047647-V	EURO CARGO 85-120-130-150 SERİSİ	ŞANZIMAN ARKA Gearbox Rear	40100503	42538259	12014424	-	65,00	85,00		13,00	9,50	L13L SOL -Left	FKM
047839-VAE	KAMYON-ÇEKİCİ SERİSİ ZF S5-423	ŞANZIMAN ARKA Gearbox Rear	2965403	42487487	20027594	12014436	70,00	90,00	-	10,00	-	L3TL SOL -Left	FKM+AEM
047511	190-643	ŞANZIMAN ARKA Gearbox Rear	40000410	-	12011439	-	70,00	100,00		12,00		L1	NBR

ŞANZIMAN GRUBU / Gearbox Group

SKT NO	KULLANILAN MODELLER Models	KULLANIM YERİ Place Of Use	ORJİNAL NO 1 Original No 1	ORJİNAL NO 2 Original No 2	EŞDEĞER NO 1 Equivalent No 1	EŞDEĞER NO 2 Equivalent No 2	ÖLÇÜLER - MM. Dimensions - MM.					TİP Type	MALZEME Material
047645-V	EURO CARGO 120 SERİSİ EATON 8209	ŞANZIMAN ARKA Gearbox Rear	40100490	-	12013860	034.347	78,00	100,00		10,00		L13TL SOL -Left	FKM
047650-V	400-440 SERİSİ ZF 9S75	ŞANZIMAN ARKA Gearbox Rear	750111334	-	20027765	587.966	80,00	100,00		8,00		L3TL SOL -Left	FKM
047711-V	400-440 SERİSİ ZF 9S75	ŞANZIMAN ARKA Gearbox Rear	750111334	-	01020467	587.966	80,00	100,00		10,00		L13TL SS-RL	FKM
410227	KAMYON SERİSİ	ŞANZIMAN ARKA Gearbox Rear	42486028	42493818	12011340	556.807	85,00	105,00		10,00		L1	NBR
410348-V	S6-90/S5	ŞANZIMAN ARKA Gearbox Rear	42485827	9931649	12013757	033.464	85,00	105,00		10,00		L1 SOL-Left	FKM
410386-V	260-330 SERİSİ	ŞANZIMAN ARKA Gearbox Rear	42482827	9931649	12013757	033.464	85,00	105,00		10,00		L3TL SOL -Left	FKM
410435-V	EURO CARGO SERİSİ	ŞANZIMAN ARKA Gearbox Rear	7981666	-	20034608	-	90,00	125,00		12,00		L3TL SOL -Left	FKM
410368-V	FULLER RTOX-R340 T1	ŞANZIMAN ARKA Gearbox Rear	1905085	42490447	12012235	967.850	95,30	114,29		11,88		L13TL SS-RL	FKM
410403-V	EURO-CARGO/TECH-STRALIS-440-ZF 9S16S-109/221	ŞANZIMAN ARKA Gearbox Rear	93193253	42492379	01026691	314.994	105,00	125,00		12,00	9,50	L13TL SOL -Left	FKM
412344-V	300-320- EURO 440 TÜM SERİLER	ŞANZIMAN ARKA Gearbox Rear	8198823	-	01018282	-	105,00	130,00		12,00		L13TL SOL -Left	FKM
412100	190-26 KAMYON SERİSİ	ŞANZIMAN ARKA Gearbox Rear	38515091	-	12011062	282.200	105,00	130,00	-	13,00	-	L3	NBR
412290-V	-	ŞANZIMAN ARKA-DIŞ Gearbox Rear - Outer	93094330	93094331	01016923	490.840	105,00	130,00		11,00		L13L SOL -Left	FKM
047830-P	TÜM MODELLER ZF 16S 151-181	ŞANZIMAN YARDIMCI MİLİ Gearbox Auxiliary Shaft	0501314060	0501320435	01017789	-	77,00	95,30		6,00		L5	ACM
041113	STRALIS-441 12AS2301-16S151	ŞANZIMAN MİLİ Gearbox Axle	93190507	-	12015561	01026544	30,00	37,00		4,00		L2T	NBR
045058	642	ŞANZIMAN MİLİ Gearbox Axle	745332	9006457	12010928	-	38,00	60,00		10,00		L3	NBR
040774-V	ZF 9S75 ŞANZ.	ŞANZIMAN KLM.ÇIKIŞ MİLİ Speedometer Shaft	1122949	1273109	01002259	010.804	10,00	15,00		3,00		L5	FKM
045575-P	697	PTO MİLİ Power Take Off Shaft	40000370	-	12001744	-	45,00	65,00		10,00		L1	ACM
047349	EUROCARGO-85-100-130	PTO MİLİ Power Take Off Shaft	93163800	-	12014929	-	50,00	80,00		8,00		L3	NBR

ŞANZIMAN GRUBU / Gearbox Group

SKT NO	KULLANILAN MODELLER Models	KULLANIM YERİ Place Of Use	ORJİNAL NO 1 Original No 1	ORJİNAL NO 2 Original No 2	EŞDEĞER NO 1 Equivalent No 1	EŞDEĞER NO 2 Equivalent No 2	ÖLÇÜLER - MM. Dimensions - MM.				TİP Type	MALZEME Material	
047591-P	EUROSTAR-EUROTECH-STRALIS-400-440	PTO MİLİ Power Take Off Shaft	42486609	40000520	12011282	446.602	55,00	80,00		10,00		L1L	ACM
415207-V	EUROCARGO/EUROTRAK	PTO MİLİ Power Take Off Shaft	40101430	40101200	12015780	121.680	140,00	165,00		13,00	12,00	L13TL SOL -Left	FKM
415209-V	EURO TECH-CARGO-STRALIS-TRAKKER- STAR-440 SERİSİ	PTO MİLİ Power Take Off Shaft	40101770	-	12029761	-	140,00	167,00		13,00		L13TL SAĞ -Right	FKM
040182	110-130 SERİSİ	ŞANZ. DEBRİYAJ KEÇESİ Clutch Shaft Seal	01273789	-	01002369	164.500	14,00	24,00		7,00		L3	NBR
040713	EUROSTAR-EUROTECH-400-440-FULLER	ŞANZ. DEBRİYAJ KEÇESİ Clutch Shaft Seal	8193879	-	12002188	120.103	22,00	35,00		7,00		L3L	NBR
041177	TÜM MODELLER-400-440 ZF 9S75-109- 16S109-221-151-181	ŞANZ. DEBRİYAJ KEÇESİ Clutch Shaft Seal	40101080	2961557	12014616	038.083	25,00	35,00		7,00		L13TL	NBR
041174	8S-151	ŞANZ. DEBRİYAJ KEÇESİ Clutch Shaft Seal	-	-	12010846	125.208	25,00	35,00		7,00		L3	NBR
041051-V	EUROCARGO-130-150-250E21	ŞANZIMAN KULESİ Gearbox Tower	40101723	40101720	12015769	457.290	25,00	38,00	49,50	14,50		SPL3TL	FKM
041109-V	EURO CARGO 85-120-130 SERİSİ (ZF TİP)	ŞANZIMAN KULESİ Gearbox Tower	40101723	40101720	12015769	457.290	25,00	38,00	49,50	14,50		SPL3CTL	FKM
041106-V	STRALIS-440-16S151	ŞANZIMAN KULESİ Gearbox Tower	93191207	-	01029609	733.480	25,00	40,00	49,00	15,00		SPL13CTL	FKM
041108-NL	STRALIS-EUROSTAR CURSOR 440 ZF16S151	ŞANZ. DEBRİYAJ KEÇESİ Clutch Shaft Seal	42534650	-	01030095	-	28,00	42,00		11,00		SPL13TLL	NBR+TPU
4MH-415-H	KERAX-MAGNUM-PREMIUM ZF 16S 151	VİTES KUMANDA KULESİ Gear Control System	93193359	-	01034594	-	55,00	63,00		9,40		L	HNBR
041110-V	STRALIS-440-ZF9S-16S-109	ŞANZIMAN KULESİ Gearbox Tower	8193161	-	01029805	-	22,00	36,00	48,00	14,50		SPL3CTL	FKM
041111-V	400-440 SERİSİ ZF 9S75 ŞANZ.	ŞANZIMAN KULESİ Gearbox Tower	0501316333	-	01032393	-	22,00	36,00	57,00	14,50		SPL3CTL	FKM
4P-228-H	ZF 16S 151-181-221-2220-2221-2521-2330-2331 ŞANZ.	ŞANZ. AKTAR. PİSTONU Gearbox Piston	42530451	0734307294	49378203	-	50,00	90,00		7,50		PC	HNBR
4P-262-V	STRALIS-CURSOR 9S109-16S109-130-150-151-181-221 ŞANZ.	ŞANZIMAN PİSTON KEÇESİ Gearbox U Packing Seal	0750112089	-	504.540	5045400	53,00	63,00		16,20		PCX4	FKM
047101	50 NC	KARDAN MİLİ SİSTEMİ Propeller Shaft	4655211	741605	12010988	-	55,00	90,00		10,00		L3	NBR
047101-V	50 NC	KARDAN MİLİ SİSTEMİ Propeller Shaft	4655211	741605	12010988	-	55,00	90,00		10,00		L3	FKM

ŞANZİMAN GRUBU / Gearbox Group

SKT NO	KULLANILAN MODELLER Models	KULLANIM YERİ Place Of Use	ORJİNAL NO 1 Original No 1	ORJİNAL NO 1 Original No 2	EŞDEĞER NO 1 Equivalent No 1	EŞDEĞER NO 1 Equivalent No 2	ÖLÇÜLER - MM. Dimensions - MM.					TİP Type	MALZEME Material
412101	697 N	KARDAN MİLİ SİSTEMİ Propeller Shaft	25383362	5109079	12011070	-	115,00	140,00		13,00		L3	NBR

DİREKSİYON GRUBU / Steering Group

SKT NO	KULLANILAN MODELLER Models	KULLANIM YERİ Place Of Use	ORJİNAL NO 1 Original No 1	ORJİNAL NO 1 Original No 2	EŞDEĞER NO 1 Equivalent No 1	EŞDEĞER NO 1 Equivalent No 2	ÖLÇÜLER - MM. Dimensions - MM.					TİP Type	MALZEME Material
040847	50 NC	DİREKSİYON MİLİ Steering Shaft	2982310	767755	12011123	038.164	25,00	40,00		7,00		L3BTL	NBR
040519	50 NC	DİREKSİYON MİLİ Steering Shaft	217018	-	-	-	25,00	40,00		8,00		L3L	NBR
040848	130-697-50NM	DİREKSİYON MİLİ Steering Shaft	40000561	-	01001676	-	25,00	47,00		6,00		L3BTL	NBR
040694	50 NC	DİREKSİYON MİLİ Steering Shaft	1268104	01167498	12011143	251402	35,00	47,00		7,00		L3BTL	NBR
040466	50 NC (HEMA TİP POMPA)	DİREKSİYON MİLİ Steering Shaft	4P100023	-	-	-	17,46	30,25		7,93		L1BL	NBR
040820	EUROCARGO S542 ŞANZ.	VİTES SEÇİCİ MİLİ Gear Selection Shaft	42550913	-	12016820	-	20,00	30,00		7,00	8,00	L3BTL	NBR
040519	50 NC	DİREKSİYON ÜST KUTU Steering Box	-	-	19033769	-	25,00	40,00		8,00		L3L	NBR
040743	-	DİREKSİYON KUTUSU Steering Box	42488743	-	12014826	006.408	26,00	37,00		7,00	8,00	L3BTL	NBR
040847	50 NC	DİREK. SEKTÖR MİLİ Steering Sector Shaft	2982310	767755	12011123	038.164	25,00	40,00		7,00		L3BTL	NBR
040929	EUROTRAKKER KAMYON-ÇEKİCİ SERİSİ	DİREKSİYON KUTUSU Steering Box	0770080252	0770198134	01020066	-	26,00	34,00		4,50	7,00	SPL3BL	NBR
040320	650	DİREK. SEKTÖR MİLİ Steering Sector Shaft	1484523	-	-	-	31,75	42,95		7,93		L3L	NBR

DİĞER ÜRÜNLER / Other Parts

SKT NO	KULLANILAN MODELLER Models	KULLANIM YERİ Place Of Use	ORJİNAL NO 1 Original No 1	ORJİNAL NO 1 Original No 2	EŞDEĞER NO 1 Equivalent No 1	EŞDEĞER NO 1 Equivalent No 2	ÖLÇÜLER - MM. Dimensions - MM.				TİP Type	MALZEME Material	
4P-249	75.12-80.12-85.12-M23-24-29-50-35.9	HAVALI KAPI PİSTON KEÇESİ Air Door Sytem	8018B	-	-	-	12,00	60,00		22,00		PCX3	NBR
040166	75.12-80.12-85.12-M23-24-29-50-35.9	KAPI SİSTEMİ Air Door System	30187487	-	12010827	-	20,00	40,00		10,00		L3	NBR

MOTOR GRUBU / Engine Group

SKT NO	KULLANILAN MODELLER Models	KULLANIM YERİ Place Of Use	ORJİNAL NO 1 Original No 1	ORJİNAL NO 2 Original No 2	EŞDEĞER NO 1 Equivalent No 1	EŞDEĞER NO 2 Equivalent No 2	ÖLÇÜLER - MM. Dimensions - MM.					TİP Type	MALZEME Material
047873-FP	L-TGA-TGL-TGM SERİSİ	KRANK ÖN Crank Shaft Front	51015107000	51015100219	15027677	061.680	66,00	90,00		12,00		F25TL SAĞ -Right	PTFE+ACM
412360-FP	TGA	KRANK ÖN Crank Shaft Front	51015100236	51015100273	20034797	20031177	100,00	130,00		12,00		F25TL SAĞ -Right	PTFE+ACM
412275-V	TÜM MODELLER	KRANK ÖN Crank Shaft Front	81965020350	81965030092	01016267	524.973	105,00	130,00		11,00		L13L SAĞ -Right	FKM
412359-FP	TGA-E-F-SL200-33372	KRANK ÖN Crank Shaft Front	51015106004	51015016018	01017541	766.853	105,00	130,00		12,00		F25TL SAĞ -Right	PTFE+ACM
412391-V	TÜM MODELLER	KRANK ÖN Crank Shaft Front	-	-	12014447	524.972	105,00	130,00		12,00		L13TL SAĞ -Right	FKM
047643-S	M90 SERİSİ	KRANK ARKA Crank Shaft Rear	81965030139	-	12013361	587.966	80,00	100,00		10,00		L1L SOL-Left	VMQ
412368-FP	TGA/TGL/TGM-L SERİSİ	KRANK ARKA Crank Shaft Rear	51015100218	51015100281	20029606	503.208	110,00	130,00		13,00		F25TL SOL -Left	PTFE+ACM
412189-S	KAMYON - OTOBÜS SERİSİ	KRANK ARKA Crank Shaft Rear	51015100151	-	12.015.384	323.772	110,00	130,00	-	13,00	-	L1L SOL-Left	VMQ
412357-FP	TGA-E15-T12 SERİSİ	KRANK ARKA Crank Shaft Rear	51015100272	-	20029785	445.600	115,00	140,00		13,00		F25TL SOL -Left	PTFE+ACM
412276-V	TÜM MODELLER	KRANK ARKA Crank Shaft Rear	51015100133	-	12014877	562.920	120,00	140,00		13,00		LL13 SOL -Left	FKM
412358-FP	TGA-E-F19372,19422, 33372, SL200	KRANK ARKA Crank Shaft Rear	51015100206	51015100141	01016688	766.829	120,00	140,00		13,00		F25TL SOL -Left	PTFE+ACM
415200-V	SG272 BELEDİYE TİP OTOBÜS	KRANK ARKA Crank Shaft Rear	-	-	-	-	143,00	158,00		11,00		L13TL SOL -Left	FKM
045990-V	TGA SERİSİ	EKSANTRİK MİLİ Cam Shaft	06562790359	-	12015120	419.730	55,00	70,00		8,00		L13TL SAĞ -Right	FKM
45-050-V	TGA SERİSİ	SUPAP Valve Stem Seal	51049020033	-	19031083	814.882	9,00	12,00	15,00	10,50		LSY2T	FKM
45-035-V	KAMYON - OTOBÜS SERİSİ	SUPAP Valve Stem Seal	51049020028	-	12014525	562.298	12,00	16,00	20,00	15,00		LSY	FKM
045567-V	M2000-M90	Yağ Pompası Oil Pump	81965010410	90900991024	12013365	-	60,00	74,00		10,00		L1	FKM
040724	ESKİ MODEL-BOSCH TİPİ	YAKIT POMPASI Fuel Pump	-	-	-	-	10,00	17,00		4,00		L3	NBR
040281	ESKİ MODELLER	YAKIT POMPASI Fuel Pump	79023584	-	12015322	-	17,00	28,00		7,00		L1	NBR

MOTOR GRUBU / Engine Group

SKT NO	KULLANILAN MODELLER Models	KULLANIM YERİ Place Of Use	ORJİNAL NO 1 Original No 1	ORJİNAL NO 1 Original No 2	EŞDEĞER NO 1 Equivalent No 1	EŞDEĞER NO 1 Equivalent No 2	ÖLÇÜLER - MM. Dimensions - MM.					TİP Type	MALZEME Material
040717	415 SERİSİ	YAKIT POMPASI Fuel Pump	6562601106	-	12011112	107.794	17,00	28,00		7,00		L3L	NBR
040343	ESKİ MODELLER	YAKIT POMPASI Fuel Pump	131511	-	12010822	-	20,00	30,00		5,00		L3	NBR
040745-V	E-F-TGA-TGL SERİSİ	YAKIT POMPASI Fuel Pump	81965010702	06562690606	12011122	038.075	25,00	35,00		7,00		L3TL	FKM
040186	ESKİ MODELLER	YAKIT POMPASI Fuel Pump	06562601912	-	12010880	203.408	30,00	42,00		7,00		L3	NBR
040388	ESKİ MODELLER	YAKIT POMPASI Fuel Pump	-	-	46081151	302.430	30,00	42,00		10,00		L3L	NBR
045202	ESKİ MODELLER	YAKIT POMPASI Fuel Pump	87660302810	-	-	-	45,00	60,00		7,00		L1	NBR
040844-V	-	HAVA KOMPRESÖRÜ Air Compressor	06562611609	81965010521	12014616	038.083	25,00	35,00		7,00		L3BTL	FKM
041177	YENİ MODELLER	HAVA KOMPRESÖRÜ Air Compressor	06562611609	81965010521	12014616	038.083	25,00	35,00		7,00		L13TL	NBR
040147	ESKİ MODELLER	HAVA KOMPRESÖRÜ Air Compressor	0049971646	-	12010848	12010847	25,00	37,00		7,00		L3	NBR

AKS GRUBU / Axle Group

SKT NO	KULLANILAN MODELLER Models	KULLANIM YERİ Place Of Use	ORJİNAL NO 1 Original No 1	ORJİNAL NO 1 Original No 2	EŞDEĞER NO 1 Equivalent No 1	EŞDEĞER NO 1 Equivalent No 2	ÖLÇÜLER - MM. Dimensions - MM.					TİP Type	MALZEME Material
045731	TGA	ÖN AKS Front Axle	06562790138	06562710807	01020676	041.114	50,00	65,00		8,00		L1L	NBR
410232	NEOPLAN CITYLINER	ÖN AKS Front Axle	06562890216	-	12014000	592.609	100,00	120,00		13,00		SL	NBR
410200	1513 L/LK SERİSİ	ÖN AKS Front Axle	06562890009	-	12014001	81-35096-00	100,00	125,00		13,00		SL	NBR
412287	SL200,6281, 26281, 26321,33372	ÖN AKS Front Axle	06562890315	06562710324	12016930	01018440	100,00	130,00		12,00		L13TL	NBR
412212-V	KAMYON - OTOBÜS SERİSİ	ÖN AKS Front Axle	83965010007	06562890368	-	-	100,00	130,00	-	13,00	-	L1	FKM
412212	E2000-F2000 OTOBÜS	ÖN AKS Front Axle	83965010007	06568200605	-	-	100,00	130,00		13,00		L1	NBR

AKS GRUBU / Axle Group

SKT NO	KULLANILAN MODELLER Models	KULLANIM YERİ Place Of Use	ORJİNAL NO 1 Original No 1	ORJİNAL NO 2 Original No 2	EŞDEĞER NO 1 Equivalent No 1	EŞDEĞER NO 2 Equivalent No 2	ÖLÇÜLER - MM. Dimensions - MM.					TİP Type	MALZEME Material
412019	KAMYON OTOBÜS EM	ÖN AKS Front Axle	06562890113	-	01001450	-	105,00	130,00		13,00		SL	NBR
412313	ESKİ MODELLER	ÖN AKS Front Axle	06562890035	87660304800	12012065	12017368	110,00	130,00		13,00		SLL	NBR
412285	TGA SERİSİ	ÖN AKS Front Axle	06562821007	90752241153	12016441	457.710	120,00	150,00		15,00		L13TL SS-RL	NBR
045675	16190-22190-16281-26281	ÖN AKS KİNG PİMİ Front Axle King Pin	81965010750	06562790278	01029642	01025733	45,00	52,00		3,00		L5	NBR
045973	F90-F2000	ÖN AKS KİNG PİMİ Front Axle King Pin	06562790353	-	01012190	-	50,00	58,00		4,00		L2	NBR
412146	L2000-M2000-M90 SERİSİ	ARKA AKS Rear Axle	06562890236	-	01003701	105.422	110,00	140,00		13,00		SL	NBR
412025	L SERİSİ	ARKA AKS Rear Axle	06562890223	-	12000556	-	120,00	140,00		13,00		L3	NBR
412214	TGA SERİSİ	ARKA AKS Rear Axle	06562890333	-	12014739	768.057	125,00	150,00		15,00		SL	NBR
415239-V	OTOBÜS SERİSİ-ZF AKS	ARKA AKS Rear Axle	36965030001	-	12019945	-	130,00	170,00		18,00	20,00	SC12	FKM
415223-V	TGA-TGM-L SERİSİ	ARKA AKS Rear Axle	06562890387	-	12020156	485.890	132,00	160,00		10,00		L1	FKM
415225-V	TGA-TGL-L-OTOBÜS	ARKA AKS Rear Axle	1965030333	81965030399	19036785	426.930	132,00	172,00		12,00		SC - ABS	FKM
415070	ESKİ MODELLER	ARKA AKS Rear Axle	06562890039	-	12011371	-	135,00	160,00		13,00		SL	NBR
420072-VP	L2000-M2000-NM-SM SERİSİ	ARKA AKS ABS Lİ Rear Axle with Abs	81965030298	-	19036752	-	135,00	175,00	205,00	18,00		SPSC ABS	FKM+ACM
415078	KAMYON SERİSİ EM	ARKA AKS Rear Axle	06562890185	06562890186	12011349	255.637	140,00	160,00		13,00		L1	NBR
415098	ESKİ MODELLER	ARKA AKS Rear Axle	83965010005	-	-	-	145,00	175,00		13,00	15,00	L1L	NBR
415117	E-F-L SERİSİ	ARKA AKS Rear Axle	06562890063	06562890065	12011407	-	145,00	175,00		13,00		SL	NBR
415117-V	26321, 33372, SL200, 26270, 16281	ARKA AKS Rear Axle	06562890033	-	12014739	768.057	145,00	175,00		13,00		SL	FKM
415141	TGA-E-F-L SERİSİ	ARKA AKS Rear Axle	06562890027	06562890064	12011374	208.210	145,00	175,00		14,00		L1L	NBR

AKS GRUBU / Axle Group

SKT NO	KULLANILAN MODELLER Models	KULLANIM YERİ Place Of Use	ORJİNAL NO 1 Original No 1	ORJİNAL NO 2 Original No 2	EŞDEĞER NO 1 Equivalent No 1	EŞDEĞER NO 2 Equivalent No 2	ÖLÇÜLER - MM. Dimensions - MM.					TİP Type	MALZEME Material
417116	E-F-L-TGA SERİSİ	ARKA AKS DIŞ Rear Axle Outer	06562890335	81965010861	12014740	768.065	145,00	175,00		14,00	12,00	L13L	NBR
415172-V	26321, 33372, SL200, 26270, 16281	ARKA AKS Rear Axle	06562890309	06562890386	01016689	826.774	145,00	175,00		16,00		L13TL SS-RL	FKM
420063	TGA-E-F-L SERİSİ	ARKA AKS Rear Axle	06562890371	-	01027787	147.730	145,00	175,00	205,00	9,00	14,00	SPL1 ABS	NBR
4SP-004	SETRA-TRAVEGO SERİSİ	ARKA AKS SACI-4TM-163	3858500068	-	19035979	-	147,20	173,70		1,50		SP	SAC
417113	TGA-TGL-F-L-E SERİSİ	ARKA AKS İÇ Rear Axle Inner	06562890366	06562890050	01019887	104.480	160,00	180,00		10,00		L13TL SS-RL	NBR
415237-V	TGA-TGM-TGL-TGX-33.360	ARKA AKS DIŞ Rear Axle Outer	81965030530	81965030445	12020154	517.131	139,00	170,00		11,00		L13TL	FKM
420070-V	TGA-TGM-TGL-TGX-33.360 SERİSİ	ARKA AKS-İÇ KEÇE-ABS Lİ Rear Axle With Abs	81965036000	-	12019683	457.300	139,00	175,00	205,00	11,00	16,30	SPSC ABS	FKM
4TM-164	TGA-TGL-TGS-TGX-M2000 (415223-V+415225-V)	ARKA AKS TAMİR TAKIMI Rear Axle Repair Kit	-	-	-	-	-	-	-	-	-	TM	-
4TM-056	ESKİ MODELLER (KEÇE+O-RING SETİ)	ARKA AKS KEÇE TAM.TK. Rear Axle Repair Kit	346 334 0080 S	6243560080/M	19030143	208.230						TM	-
4TM-156	ESKİ MODELLER (FULL SET)	ARKA AKS KEÇE TAM.TK. Rear Axle Repair Kit	06563414254	6243560080/M	19025771	315.621						TM	-
4TM-106	SETRA OTOBÜS (4TM-163+4SP-004)	ARKA AKS KEÇE TAM.TAK. Rear Axle Repair Kit	-	-	-	-						TM	
4H-498	E-F-ESKİ MODELLER	ARKA AKS ORİNGİ Rear Axle O-ring	06563414254	-	19019093	315.621	250,00			5,00		O	NBR
045656-V	E-TGA-TGL SERİSİ	ARKA AKS FREN MİLİ Rear Axle Brake Shaft	06562790297	-	01017009	-	42,00	55,00		9,00		SPL1	FKM
045676	ESKİ MODELLER	ARKA AKS FREN MİLİ Rear Axle Brake Shaft	06562790133	06562790311	01017010	010.197	42,00	58,00		7,00		L1	NBR

DİFERANSİYEL GRUBU / Differential Group

SKT NO	KULLANILAN MODELLER Models	KULLANIM YERİ Place Of Use	ORJİNAL NO 1 Original No 1	ORJİNAL NO 2 Original No 2	EŞDEĞER NO 1 Equivalent No 1	EŞDEĞER NO 2 Equivalent No 2	ÖLÇÜLER - MM. Dimensions - MM.					TİP Type	MALZEME Material
410267-V	M2000-M90	MAHRUTİ (DİFER.ÖN) Differential - Front	06562790275	-	01016915	-	66,67	116,02	125,40	11,90	19,25	SPL1L SS-RL	FKM

DİFERANSİYEL GRUBU / Differential Group

SKT NO	KULLANILAN MODELLER Models	KULLANIM YERİ Place Of Use	ORJİNAL NO 1 Original No 1	ORJİNAL NO 2 Original No 2	EŞDEĞER NO 1 Equivalent No 1	EŞDEĞER NO 2 Equivalent No 2	ÖLÇÜLER - MM. Dimensions - MM.					TİP Type	MALZEME Material
047757-V	26321-33372-E SERİSİ	MAHRUTİ (DİFER.ÖN) Differential - Front	06562790323	06562790323	12012575	198.420	68,00	90,00		10,00		L13TL SS-RL	FKM
410318	F2000 SERİSİ	MAHRUTİ (DİFER.ÖN) Differential - Front	06562790312	06562790328	12012573	000.559	72,00	105,00		13,00		L1L	NBR
410320	TGL-L-E SERİSİ	MAHRUTİ (DİFER.ÖN) Differential - Front	06562790073	06562790366	12014743	000.745	72,00	105,00		13,00		SL	NBR
410318-V	F SERİSİ	MAHRUTİ (DİFER.ÖN) Differential - Front	06562790312	-	12014743	000.745	72,00	105,00		13,00		L1L	FKM
410320-V	TGL-L-E SERİSİ	MAHRUTİ (DİFER.ÖN) Differential - Front	06562790073	06562790366	12014743	000.745	72,00	105,00		13,00		SL	FKM
410396-VN	TGL-L-E SERİSİ	MAHRUTİ (DİFER.ÖN) Differential - Front	06562790362	-	01026188	023.330	72,00	105,00		19,00		SPL13L SS-RL	FKM+NBR
047756	TGA-E SERİSİ	MAHRUTİ (DİFER.ÖN) Differential - Front	06562790335	-	01020042	104.320	75,00	95,00		10,00		L13TL SS-RL	NBR
047756-V	TGA-E SERİSİ	MAHRUTİ (DİFER.ÖN) Differential - Front	06562790331	-	01019480	451.140	75,00	95,00		10,00		L13TL SS-RL	FKM
412363-VN	TGA-L2000	MAHRUTİ (DİFER.ÖN) Differential - Front	81965030385	-	01030117	221.710	78,00	135,00		12,00	21,50	SPL13L SS-RL	FKM+NBR
047650-V	E-26321-33372-F-TGA-TGL ZF 9S75	MAHRUTİ (DİFER.ÖN) Differential - Front	06562790349	-	01020467	587.966	80,00	100,00		8,00		L3TL SOL -Left	FKM
410397	E-F-TGA-S220 SERİSİ	MAHRUTİ (DİFER.ÖN) Differential - Front	06562890361	-	01029595	198.430	85,00	105,00		13,00		L13TL SS-RL	NBR
410397-V	E-F-TGA-S220 SERİSİ	MAHRUTİ (DİFER.ÖN) Differential - Front	06562890357	-	01019594	198.440	85,00	105,00		13,00		L13TL SS-RL	FKM
410450-V	TGA-TGM SERİSİ	MAHRUTİ (DİFER.ÖN) Differential - Front	06562890394	-	01017056	504.560	85,00	110,00		12,00	17,00	L13LLR	FKM
412327-VN	TGA/L SERİSİ	MAHRUTİ (DİFER.ÖN) Differential - Front	81965030415	81965030415	12019701	NA5238	85,00	120,00		10,00	21,00	SLL13TL SS-RL	FKM+NBR
415254-VN	TGA-18.410-TGM-TGS-TGX	MAHRUTİ (DİFER.ÖN) Differential - Front	81965030442	81965030332	19037255	-	85,00	150,00		16,35	20,00	SPSCL13R	FKM+NBR
410489-V	OTOBÜS SERİSİ	MAHRUTİ (DİFER.ÖN) Differential - Front	81965030326	11015616	01029710	-	90,00	125,00		12,00	19,00	L3TLR SAĞ -Right	FKM
410356-V	F SERİSİ	MAHRUTİ-TAHRİKLİ AKS Differential	06562890357	06562890048	12012549	008.680	85,00	105,00		13,00		L1	FKM
047047-V	ESKİ MODELLER	MAHRUTİ-GEÇİT DİFR. Middle Rear AXLE	06562790323	-	01020466	198.420	68,00	90,00		10,00		L3	FKM

ŞANZIMAN GRUBU / Gearbox Group

SKT NO	KULLANILAN MODELLER Models	KULLANIM YERİ Place Of Use	ORJİNAL NO 1 Original No 1	ORJİNAL NO 2 Original No 2	EŞDEĞER NO 1 Equivalent No 1	EŞDEĞER NO 2 Equivalent No 2	ÖLÇÜLER - MM. Dimensions - MM.					TİP Type	MALZEME Material
							80,00	100,00		12,00			
047434	33372-26321	MAHRUTİ-GEÇİT DİFR. Middle Rear AXLE	06562890179	06562890179	01025712	008.354	80,00	100,00		12,00		L1L	NBR
046021-VK	TGL-F2000-F90 ZF55-42	ŞANZIMAN ÖN Gearbox Front	81965030431	-	01029649	12019650	40,00	52,00		8,50		L3TL SAĞ -Right	FKM +YÜN-NW
045713	ESKİ TİP-MEKANİK ŞANZ.	ŞANZIMAN ÖN Gearbox Front	90801320115	-	12011157	039.993	40,00	55,00		8,00		L3TL	NBR
046132-P	L - TGL SERİSİ	ŞANZIMAN ÖN Gearbox Front	81.96502.0200	-	12013896	040.363	42,00	62,00		10,00		L3TL SAĞ -Right	ACM
045366	ESKİ MODELLER	ŞANZIMAN ÖN Gearbox Front	07660302710	-	-	-	42,00	65,00		10,00		L3	NBR
045198	ESKİ MODELLER	ŞANZIMAN ÖN Gearbox Front	87660302811	-	01035276	-	45,00	62,00		10,00		L3	NBR
045702	ESKİ MODELLER	ŞANZIMAN ÖN Gearbox Front	06562790042	-	19019082	-	48,00	65,00		10,00		L1L	NBR
045827-V	F-TGL-TGA ZF 9S75-109	ŞANZIMAN ÖN Gearbox Front	81965020934	-	20016209	586.676	48,00	65,00		10,00		L13TL SAĞ -Right	FKM
045880-V	M90 SERİSİ	ŞANZIMAN ÖN İÇ Gearbox Front	81965020226	90900952043	12011306	284.662	48,00	69,00		10,00		L1 SAĞ-Right	FKM
045840-V	F SERİSİ	ŞANZIMAN ÖN Gearbox Front	81965020225	06562790084	12011307	033.472	48,00	75,00		8,00		L1 SAĞ-Right	FKM
045964-V	E SERİSİ	ŞANZIMAN ÖN Gearbox Front	81965020403	-	12018806	141.960	52,00	68,00		8,00		L13TL SAĞ -Right	FKM
045851-V	E-F-TGA SERİSİ ZF 16S 151	ŞANZIMAN ÖN Gearbox Front	81965030342	81965020761	12011308	284.645	55,00	75,00		8,00		L1 SAĞ-Right	FKM
046115-P	E-F-TGA-NEOPLAN SERİSİ	ŞANZIMAN ÖN Gearbox Front	81965030475	-	01031969	515.340	55,00	75,00		8,00	9,20	L1R SAĞ -Right	ACM
047343	ESKİ MODELLER	ŞANZIMAN ÖN Gearbox Front	81965010308	-	01002684	12011533	70,00	90,00		10,00		L1	NBR
047811-V	26321	ŞANZIMAN ÖN Gearbox Front	81965010308	-	12014700	763.144	70,00	90,00		10,00		L13TL SAĞ -Right	FKM
046011	ZF ŞANZ. ZF 9S75-9S109	ŞANZIMAN ÖN Gearbox Front	0501311146	-	01017792	-	60,00	74, 80		4, 70		SPL5	NBR
045567	ESKİ MODELLER	ŞANZIMAN ARKA Gearbox Rear	06562790131	-	-	-	60,00	74,00		10,00		L1	NBR
047647-V	M2000 OTOBÜS-EATON 4106-8209 ŞANZ.	ŞANZIMAN ARKA Gearbox Rear	81965030229	-	12014424	-	65,00	85,00		13,00	9,50	L3L SOL-Left	FKM

ŞANZIMAN GRUBU / Gearbox Group

SKT NO	KULLANILAN MODELLER Models	KULLANIM YERİ Place Of Use	ORJİNAL NO 1 Original No 1	ORJİNAL NO 2 Original No 2	EŞDEĞER NO 1 Equivalent No 1	EŞDEĞER NO 2 Equivalent No 2	ÖLÇÜLER - MM. Dimensions - MM.					TİP Type	MALZEME Material
047581	KAMYON-OTOBÜS	ŞANZIMAN ARKA Gearbox Rear	-	-	12011410	246.891	70,00	90,00		10,00		SLL	NBR
047839-VAE	KAMYON-ÇEKİCİ SERİSİ ZF S5-424	ŞANZIMAN ARKA Gearbox Rear	81965020251	-	20027594	12014336	70,00	90,00	-	10,00	-	L3TL SOL -Left	FKM+AEM
047645-V	TGL SERİSİ	ŞANZIMAN ARKA Gearbox Rear	81320500451	-	12013860	034.347	78,00	100,00		10,00		L13TL SOL -Left	FKM
047859-V	YENİ MODELLER	ŞANZIMAN ARKA Gearbox Rear	-	-	01033293	-	80,00	100,00		10,00	15,50	L13LL SOL -Left	FKM
047711-V	E-26321-33372-F-TGA-TGL ZF 9S75	ŞANZIMAN ARKA Gearbox Rear	06562790349	-	01020467	587.966	80,00	100,00		10,00		L13TL SS-RL	FKM
410237	ESKİ MODELLER	ŞANZIMAN ARKA Gearbox Rear	06562890181	-	12014732	12011340	85,00	105,00		10,00		SL	NBR
410386-V	M90-M2000 SERİSİ	ŞANZIMAN ARKA Gearbox Rear	06562890067	81965010451	12013757	033.464	85,00	105,00		10,00		L3TL SOL -Left	FKM
410348-V	MEKANİK ŞANZ.	ŞANZIMAN ARKA Gearbox Rear	81965010966	-	01011312	12013757	85,00	105,00		10,00		L1 SOL-Left	FKM
410376-V	ZF-9S109 ŞANZ.	ŞANZIMAN ARKA Gearbox Rear	-	-	01029684	222.830	95,00	115,00		13,00		L13TL SOL -Left	FKM
410368-V	F90-ESKİ MODELLER	ŞANZIMAN ARKA Gearbox Rear	81965020451	-	12012235	967.850	95,30	114,29		11,28		L13TL SS-RL	FKM
410403-V	E-F-TGA-TGL -NEOPLAN SERİSİ 9S-109-16S109	ŞANZIMAN ARKA Gearbox Rear	81965030220	-	01026691	-	105,00	125,00		12,00	9,50	L13TL SOL -Left	FKM
412344-P	E-F-TGA SERİSİ-F2000	ŞANZIMAN ARKA Gearbox Rear	81965030236	-	01016923	515.350	105,00	130,00		12,00		L13TL SOL -Left	ACM
412344-V	OTOBÜS-KAMYON SERİSİ-ZF TİPŞANZ	ŞANZIMAN ARKA Gearbox Rear	81965030092	81965020350	01018282	314.994	105,00	130,00		12,00		L13TL SOL -Left	FKM
412019	F SERİSİ	ŞANZIMAN ARKA Gearbox Rear	81965020349	-	12011062	282.200	105,00	130,00		12,00		SL	NBR
412100	F90 SERİSİ-EM	ŞANZIMAN ARKA Gearbox Rear	81965020349	-	12011062	282.200	105,00	130,00	-	13,00	-	L3	NBR
047521	TGA SERİSİ	ŞANZIMAN ARKA-DIŞ Gearbox Rear - Outer	06562890353	-	01020468	104.320	80,00	100,00		10,00		L1L	NBR
412290-V	ZF-16S 151	ŞANZIMAN ARKA-DIŞ Gearbox Rear - Outer	81965020350	81965030092	01018282	314.994	105,00	130,00		11,00		L13L SOL -Left	FKM
047830-P	TÜM MODELLER ZF 16S 151-181	ŞANZIMAN YARDIMCI MİLİ Gearbox Auxiliary Shaft	0501314060	0501320435	01017789	-	77,00	95,30		6,00		L5	ACM

ŞANZIMAN GRUBU / Gearbox Group

SKT NO	KULLANILAN MODELLER Models	KULLANIM YERİ Place Of Use	ORJİNAL NO 1 Original No 1	ORJİNAL NO 2 Original No 2	EŞDEĞER NO 1 Equivalent No 1	EŞDEĞER NO 2 Equivalent No 2	ÖLÇÜLER - MM. Dimensions - MM.					TİP Type	MALZEME Material
040774-V	E-F-TGA-TGL ZF 9S75 ŞANZ.	ŞANZIMAN KLM.ÇIKIŞ MİLİ Speedometer Shaft	06562690479	06562690527	01002259	010.804	10,00	15,00		3,00		SPL5	FKM
040188	ESKİ MODELLER	ŞANZIMAN KLM.ÇIKIŞ MİLİ Speedometer Shaft	06562611207	-	12010817	-	18,00	30,00		7,00		L3	NBR
410227	M90-M2000 SERİSİ	ŞANZIMAN ARKA Gearbox Rear	06562890132	81965010446	12011340	556.807	85,00	105,00		10,00		L1	NBR
040182	ESKİ MODELLER	ŞANZ. DEBRİYAJ KEÇESİ Clutch Shaft Seal	06562610804	-	12010784	164.500	14,00	24,00		7,00		L3	NBR
040769	KAMYON-ÇEKİCİ SERİSİ	VİTES SEÇİCİ MİLİ Gear Selection Shaft	112300870019	06562890550	-	-	12,00	20,00	-	5,00	-	L1	NBR
040820	TGA SERİSİ	VİTES SEÇİCİ MİLİ Gear Selection Shaft	81965030452	-	12016820	-	20,00	30,00		7,00	8,00	L3BTL	NBR
040844	TGA SERİSİ	VİTES SEÇİCİ MİLİ Gear Selection Shaft	06562611609	81965010521	12014616	038.083	25,00	35,00	-	6,00	-	L3BTL	NBR
040745	ZF-9S109 ŞANZ.	ŞANZ. DEBRİYAJ KEÇESİ Clutch Shaft Seal	06562690606	81965010702	12011122	038.075	25,00	35,00		7,00		L3TL	NBR
041177	E-F-TGA-TGL SERİSİ ZF 9S75	ŞANZ. DEBRİYAJ KEÇESİ Clutch Shaft Seal	06562611609	81965010521	12014616	038.083	25,00	35,00		7,00		L13TL	NBR
041051-V	E-L SERİSİ	ŞANZIMAN KULESİ Gearbox Tower	81964010148	-	12015769	457.290	25,00	38,00	49,50	14,50		SPL3TL	FKM
041109-V	F-TGA SERİSİ	ŞANZIMAN KULESİ Gearbox Tower	81964010148	-	12015769	-	25,00	38,00	49,50	14,50		SPL3CTL	FKM
041106-V	E-F-TGA SERİSİ	ŞANZIMAN KULESİ Gearbox Tower	81964010163	-	01029609	733.480	25,00	40,00	49,00	15,00		SPL13CTL	FKM
040765-V	KAMYON GRUBU	ŞANZIMAN KULESİ Gearbox Tower	0059973547	-	01026333	-	30,00	40,00	-	7,00	-	L3L	FKM
041108-NL	NEOPLAN-EUROLINER (ZF TİP)	ŞANZ. DEBRİYAJ KEÇESİ Clutch Shaft Seal	0734309765	0734309376	01030095	-	28,00	42,00		11,00		SPL13TLL	NBR+TPU
4MH-415-H	TGA SERİSİ	VİTES KUMANDA KULESİ Gear Control System	81325270022	-	01034594	-	55,00	63,00		9,40		L	HNBR
041113	NEOPLAN-EUROLINER (ZF TİP)	ŞANZ. DEBRİYAJ KEÇESİ Clutch Shaft Seal	0750111575	-	12015561	01026544	30,00	37,00		4,00		L2T	NBR
041110-V	TGA SERİSİ ZF 9S109-16S109	ŞANZIMAN KULESİ Gearbox Tower	0750112047	89200221038	01029805	-	22,00	36,00	48,00	14,50		SPL3CTL	FKM
041111-V	E-F-TGA-TGL ZF 9S75 ŞANZ.	ŞANZIMAN KULESİ Gearbox Tower	0501316333	-	01032393	-	22,00	36,00	57,00	14,50		SPL3CTL	FKM

ŞANZİMAN GRUBU / Gearbox Group

SKT NO	KULLANILAN MODELLER Models	KULLANIM YERİ Place Of Use	ORJİNAL NO 1 Original No 1	ORJİNAL NO 1 Original No 2	EŞDEĞER NO 1 Equivalent No 1	EŞDEĞER NO 1 Equivalent No 2	ÖLÇÜLER - MM. Dimensions - MM.					TİP Type	MALZEME Material
4P-228-H	ZF 16S 151-181-221-2220-2221-2521-2330-2331 ŞANZ.	ŞANZ. AKTAR. PİSTONU Gearbox Piston	81965030230	0734307294	49378203	-	50,00	90,00		7,50		PC	HNBR
4P-262-V	10-153 19-422 32-270 19-360 - 95109-165109-130-150-151-181-221 ŞANZ.	ŞANZİMAN PİSTON KEÇESİ Gearbox U Packing Seal	81965030019	81965030019	504.540	5045400	53,00	63,00		16,20		PCX4	FKM
4P-260-H	ZF 9S75 ŞANZ.	TAKVİYE PİSTON KEÇESİ Reinforcement Piston Seal	81965030377	0734309380	12014454	-	63,00	16,00		10,50		LS	HNBR
047456	ESKİ MODELLER	KARDAN MİLİ SİSTEMİ Propeller Shaft	87660900301	-	12011192	12010999	60,00	80,00		10,00	12,00	L3L	NBR

DİREKSİYON GRUBU / Steering Group

SKT NO	KULLANILAN MODELLER Models	KULLANIM YERİ Place Of Use	ORJİNAL NO 1 Original No 1	ORJİNAL NO 1 Original No 2	EŞDEĞER NO 1 Equivalent No 1	EŞDEĞER NO 1 Equivalent No 2	ÖLÇÜLER - MM. Dimensions - MM.					TİP Type	MALZEME Material
040744	ESKİ MODELLER	DİREKSİYON KUTUSU Steering Box	-	-	237.744	-	28,00	40,00		7,00	8,00	L3BTL	NBR
041093-V	KAMYON - OTOBÜS SERİSİ	DİREKSİYON POMPASI Power Steering Pump	0770198101	0770080228	-	-	17,00	28,00		6,50	0,00	L13X	FKM
040975	-	DİREKSİYON POMPASI Power Steering Pump	81965020116	-	12015495	-	17,00	30,00		7,00	8,00	L1BL	NBR
041159-V	NEOPLAN - ZF TİP POMPA	DİREKSİYON POMPASI Power Steering Pump	0770 080 437	-	-	-	20,00	35,00	-	8,00	-	L13XT	FKM
040506	ZF TİP	DİREKSİYON POMPASI Power Steering Pump	-	-	-	-	20,00	35,00		8,00		L3X	NBR
040441	ESKİ MODELLER	DİREKSİYON POMPASI Power Steering Pump	-	-	12000583	-	25,00	35,00		8,00		L3X	NBR
040929	ESKİ MODELLER	DİREKSİYON POMPASI Power Steering Pump	770080252	0770198134	01020066	-	26,00	34,00		4,50	7,00	SPL3BL	NBR
041179	YENİ MODELLER	DİREKSİYON POMPASI Power Steering Pump	-	-	12012574	237.744	28,00	40,00		8,00	10,00	L13TL	NBR

MOTOR GRUBU / Engine Group

SKT NO	KULLANILAN MODELLER Models	KULLANIM YERİ Place Of Use	ORJİNAL NO 1 Original No 1	ORJİNAL NO 2 Original No 2	EŞDEĞER NO 1 Equivalent No 1	EŞDEĞER NO 2 Equivalent No 2	ÖLÇÜLER - MM. Dimensions - MM.					TİP Type	MALZEME Material
047383-V	312-321-327-1413-2517-2521-2524-3224	KRANK ÖN Crank Shaft Front	0149971647	0179977547	01016759	553.272	65,00	90,00		13,00		L3L	FKM
047768-V	1817-1821-1824-OM 352-A OM 353-1513 LK	KRANK ÖN Crank Shaft Front	0069975446	0069978547	12014380	283.983	65,00	90,00		13,00		L13TL SAĞ -Right	FKM +YÜN-NW
047463-S	1513-UNIMOG-OM.352.A ESKİ MOD. MOT.	KRANK ÖN Crank Shaft Front	0099977747	-	20027937	283.983	65,00	90,00		15,00		L1 SAĞ-Right	VMQ
047653-V	302-2624-2628	KRANK ÖN Crank Shaft Front	0119975747	0049973947	12011674	525.316	75,00	100,00		12,00	13,00	L1CL SAĞ -Right	FKM
410447-FP	AXOR-ATEGO 904-906 MOT.	KRANK ÖN Crank Shaft Front	0229977647	0139976046	20025510	445.591	78,00	104,00		11,00		F25TL SAĞ -Right	PTFE+ACM
412360-FP	AXOR-ACTROS 457 TİP MOT.	KRANK ÖN Crank Shaft Front	0259973947	-	20034797	20031177	100,00	130,00		12,00		F25TL SAĞ -Right	PTFE+ACM
412275-V	AXOR-ACTROS-303-304-403-404-1844	KRANK ÖN Crank Shaft Front	0149974647	0099970747	01016267	524.973	105,00	130,00		12,00		L13L SAĞ -Right	FKM
412359-FP	AXOR-ACTROS 501-541 MOT.	KRANK ÖN Crank Shaft Front	0149944647	-	01017541	766.853	105,00	130,00		12,00		F25TL SAĞ -Right	PTFE+ACM
412391-V	TÜM MODELLER	KRANK ÖN Crank Shaft Front	0039970747	0039971747	12014447	524.972	105,00	130,00		12,00		L13TL SAĞ -Right	FKM
415240-FPK	AXOR II (10-04)	KRANK ÖN Crank Shaft Front	-	-	20036083	000.270	136,00	159,00		13,00		F2TK SAĞ -Right	PTFE+ACM +YÜN-NW
412357-FP	AXOR-ACTROS-ATEGO 457-904-906 MOT.	KRANK ARKA Crank Shaft Rear	0219975347	-	20029785	445.600	115,00	140,00		13,00		F25TL SOL -Left	PTFE+ACM
412252-V	1626-1632-OM.402/OM.403	KRANK ARKA Crank Shaft Rear	0069973347	0139971447	12014877	562.920	120,00	140,00		13,00		LL1 SOL-Left	FKM
412276-V	AXOR-ACTROS-303-304-403-404-1844	KRANK ARKA Crank Shaft Rear	0139971447	0079972446	12014877	562.920	120,00	140,00		13,00		L13L SOL -Left	FKM
412358-FP	AXOR-ACTROS 501-541 MOT.	KRANK ARKA Crank Shaft Rear	0149971347	-	01016688	766.829	120,00	140,00		13,00		F25TL SOL -Left	PTFE+ACM
415072-V	1517, 1519 4X4	KRANK ARKA Crank Shaft Rear	0049979347	0099975146	12012432	316.385	125,00	160,00		18,00		L1L SOL-Left	FKM
047383-S	312-321-327-1413-2517-2521-2524-3224	EKSANTRİK MİLİ Cam Shaft	0099975446	0069978547	12014380	283.983	65,00	90,00		13,00		L3L	VMQ
047513-V	1920 LP/LPS SERİSİ OM.346 MOT.	EKSANTRİK MİLİ Cam Shaft	0119977046	0049973947	12011674	525.316	75,00	100,00		12,00	13,00	LL1C SAĞ -Right	FKM
45-030-V	ATEGO-814	SUPAP Valve Stem Seal	9060530458	9060530358	12015512	104.380	8,00	12,00	15,20	5,70	9,50	LSY2T	FKM

MOTOR GRUBU / Engine Group

SKT NO	KULLANILAN MODELLER Models	KULLANIM YERİ Place Of Use	ORJİNAL NO 1 Original No 1	ORJİNAL NO 2 Original No 2	EŞDEĞER NO 1 Equivalent No 1	EŞDEĞER NO 2 Equivalent No 2	ÖLÇÜLER - MM. Dimensions - MM.					TİP Type	MALZEME Material
4S-051-V	AXOR-ATEGO-ACTROS 904-906 MOT.	SUPAP Valve Stem Seal	9060530458	9060530258	12015512	143.930	8,00	12,00	15,20	9,50		LSY2T	FKM
4S-050-V	AXOR-ACTROS-ATECO-TRAVEGO-457-541 MOT.	SUPAP Valve Stem Seal	0000533558	9060534958	19031083	814.882	9,00	12,00	15,40	10,50		LSY2T	FKM
4S-035-V	1844-2517-2521-1824-303-403-304-404	SUPAP Valve Stem Seal	4220530196	-	12014525	562.298	12,00	16,00	20,00	9,00	15,00	LSY	FKM
4S-018-V	2521-25171817-1821-1824-OM352/364/366 MOT.	SUPAP Valve Stem Seal	3660530058	3410530096	12015881	577.898	9,00	15,00	19,00	9,00	15,00	LSY	FKM
4S-118-V	1817-1821-1824-OM352/364/366 MOT.	SUPAP Valve Stem Seal	3660530158	3520530396	577.901	12010400	10,00	15,00	19,00	9,00	15,00	LSY	FKM
040183	312-321 SERİSİ	FAN KASNAĞI Fan Pulley	-	-	12010829	-	20,00	42,00	-	10,00	-	L3	NBR
045240	322 SERİSİ	FAN KASNAĞI Fan Pulley	35870	-	12001169	-	30,00	52,00		10,00		L3	NBR
045299	1920 LP/LPS SERİSİ OM.346 MOT.	FAN KASNAĞI Fan Pulley	0049974247	-	-	-	40,00	55,00	-	10,00	-	L3	NBR
040953	1317, 1319	YAKIT POMPASI Fuel Pump	0049974947	-	01002391	-	17,00	28,00		6,00		L1L	NBR
040745-V	1120, 1121, 1124 4x2/4x4	YAKIT POMPASI Fuel Pump	0109976947	-	12010846	135.208	25,00	35,00		7,00		L3TL	FKM
040474	ESKİ MODELLER-1517-1519	YAKIT POMPASI Fuel Pump	0039974046	-	12011330	038.490	26,00	45,00		10,00		L1L	NBR
040850	3035	YAKIT POMPASI Fuel Pump	0099971147	-	11014231	01001681	30,00	42,00		6,00	6,80	L3BTL	NBR
040150	322 SERİSİ	REGÜLATÖR MİLİ Regulator Shaft	0009979546	0029973046	12010885	-	30,00	50,00		10,00		L3	NBR
040759	305 OTOBÜS	REGÜLATÖR MİLİ Regulator Shaft	005 997 7746	-	-	-	20,00	28,00	-	6,00	-	L1	NBR
040180	643	REGÜLATÖR MİLİ Regulator Shaft	0099976947	-	12010826	12011118	20,00	40,00		7,00		L3	NBR
040260	UNIMOĞ	SU POMPASI Water Pump	1369970047	-	12010794	-	15,00	30,00		7,00		L3	NBR
040272	O309	SU POMPASI Water Pump	0029978446	0059970147	12010810	054.003	17,00	35,00		7,00		L3	NBR
040084		SU POMPASI Water Pump	0039978147	-	12010828	12012842	20,00	42,00		7,00		L3	NBR

MOTOR GRUBU / Engine Group

SKT NO	KULLANILAN MODELLER Models	KULLANIM YERİ Place Of Use	ORJİNAL NO 1 Original No 1	ORJİNAL NO 2 Original No 2	EŞDEĞER NO 1 Equivalent No 1	EŞDEĞER NO 2 Equivalent No 2	ÖLÇÜLER - MM. Dimensions - MM.					TİP Type	MALZEME Material
040204	1920-2220-2620 LP/LPS SERİSİ-OM.346	SU POMPASI Water Pump	0009974147	-	12010875	038.660	28,00	47,00		10,00		L3	NBR
045645	UNIMOG1300/1500/1700-OM-352-A	SU POMPASI Water Pump	0039975146	0059970047	12010943	344.400	42,00	56,00		7,00		L3T	NBR
040765-V	ACTROS-SK SERİSİ	YAĞ POMPASI Oil Pump	0059973547	-	01026333	-	30,00	40,00	-	7,00	-	L3L	FKM
040507	OM402 MOT.	ŞARJ DİNAMOSU Charge System	004 997 4647	-	-	-	32,00	42,00	-	7,00	10,00	L1C	NBR
045713	322 SERİSİ	ŞARJ DİNAMOSU Charge System	0029972546	-	12011157	039.993	40,00	55,00		8,00		L3TL	NBR
040506-V	ESKİ MODELLER	HAVA KOMPRESÖRÜ Air Compressor	-	-	-	-	20,00	35,00		8,00		L3X	FKM
040844-V	1120, 1121, 1124 4x2/4x4	HAVA KOMPRESÖRÜ Air Compressor	0159972947	0169972547	01026501	01034100	25,00	35,00		6,00		L3BTL	FKM
041177	AXOR-ACTROS-ATEGO	HAVA KOMPRESÖRÜ Air Compressor	0069974946	-	12014616	038.083	25,00	35,00		7,00		L13TL	NBR
040441	OTOBÜS-KAMYON EM	HAVA KOMPRESÖRÜ Air Compressor	-	-	12000583	-	25,00	35,00		8,00		L3X	NBR
040147	1317, 1319	HAVA KOMPRESÖRÜ Air Compressor	0049971646	-	12010848	12010847	25,00	37,00		7,00		L3	NBR
040144	327/1413/1513 SERİSİ	HAVA KOMPRESÖRÜ Air Compressor	0004312886	006504025201	12010859	-	25,00	47,00		10,00		L3	NBR

AKS GRUBU / Axle Group

SKT NO	KULLANILAN MODELLER Models	KULLANIM YERİ Place Of Use	ORJİNAL NO 1 Original No 1	ORJİNAL NO 2 Original No 2	EŞDEĞER NO 1 Equivalent No 1	EŞDEĞER NO 2 Equivalent No 2	ÖLÇÜLER - MM. Dimensions - MM.					TİP Type	MALZEME Material
045731	1935, 1936, 1945, 2436, 2536 4X4	ÖN AKS Front Axle	0109979746	0109979646	01020676	041.114	50,00	65,00		8,00		L1L	NBR
045742	327/1413/1513 SERİSİ	ÖN AKS Front Axle	-	-	12016509	-	50,00	65,00		10,00		L1L	NBR
045496	327/1413/1513 SERİSİ	ÖN AKS Front Axle	-	-	01032123	-	50,00	65,00	-	10,00	-	L3	NBR

AKS GRUBU / Axle Group

SKT NO	KULLANILAN MODELLER Models	KULLANIM YERİ Place Of Use	ORJİNAL NO 1 Original No 1	ORJİNAL NO 2 Original No 2	EŞDEĞER NO 1 Equivalent No 1	EŞDEĞER NO 2 Equivalent No 2	ÖLÇÜLER - MM. Dimensions - MM.					TİP Type	MALZEME Material
045653	1922, 1925, 2222, 2422, 2622 4X4	ÖN AKS Front Axle	0089979746	0069979046	01020675	108.642	50,00	70,00		9,00		L1L	NBR
047310	2624, 2628 6x4/6x6	ÖN AKS Front Axle	0099971646	3049970947	12011000	069.440	60,00	85,00		10,00		L3	NBR
047455	0302 OTOBÜS	ÖN AKS Front Axle	011 997 9846-	-	003 997 4446	-	68,00	90,00	-	13,00	10,00	L1L	NBR
047659	740.01 TİP AKS	ÖN AKS Front Axle	002 997 6547-	-	002997 8847	-	70,00	81,50	-	6,00	-	L3BT	NBR
047659-V	ACTROS-1831/35/40/43/48	ÖN AKS Front Axle	0029978847	0029976547	20016779	331.163	70,00	81,50		6,00		L3BTL	FKM
047754	ATECO-814/14 L/15/15 L/17/17	ÖN AKS Front Axle	0249976847	0139970747	01031066	-	75,00	90,00		10,00	12,30	L3TL	NBR
047756	1935-2635	ÖN AKS Front Axle	0179978347	0179973047	01020042	104.320	75,00	95,00		10,00		L3	NBR
410398	AXOR-ATEGO-ACTROS 1840-1843-1848	ÖN AKS Front Axle	0219978947	0129970846	12016794	059.480	86,00	105,00		5,00	6,00	L2TR	NBR
412147	312-321 SERİSİLP321	ÖN AKS Front Axle	0009973446	0039974047	12011399	042.714	95,00	130,00		13,00		SL	NBR
410232	302-303-1513 L/LK SERİSİ	ÖN AKS Front Axle	0079973646	-	12014000	592.609	100,00	120,00		13,00		SL	NBR
410200	1513 L/LK SERİSİ	ÖN AKS Front Axle	0069979346	-	12014001	81-35096-00	100,00	125,00		13,00		SL	NBR
412272	1823/23 L/28/28 L-	ÖN AKS Front Axle	0099976747	0109979046	12000552	814.172	100,00	130,00		13,00		L3TL	NBR
412287	303-304-403-404-1844-2517-2521-2524	ÖN AKS Front Axle	0199974747	-	12016930	01018440	100,00	130,00		13,00		L13TL	NBR
412019	312-321 SERİSİLAP321	ÖN AKS Front Axle	0039974546	0009976447	12011403	042.846	105,00	130,00		13,00		SL	NBR
412335	AXOR-ACTROS-TRAVEGO	ÖN AKS Front Axle	0219976947	-	01028965	220.450	120,00	150,00		14,30	20,00	SC L13TR	NBR
412285	AXOR-ACTROS-303-304-403-404-1844	ÖN AKS Front Axle	0199974847	0049971847	12016441	457.710	120,00	150,00		15,00		L13TL SS-RL	NBR
417031	1626-1632	ÖN AKS Front Axle	3179970047	-	12011091	109.657	150,00	180,00		13,00		L3	NBR
045973	1622-1625-1628-1733-2225-2425-2428	ÖN AKS KİNG PİMİ Front Axle King Pin	0119973546	0109974146	01012190	-	50,00	58,00		4,00		L2	NBR

AKS GRUBU / Axle Group

SKT NO	KULLANILAN MODELLER Models	KULLANIM YERİ Place Of Use	ORJİNAL NO 1 Original No 1	ORJİNAL NO 2 Original No 2	EŞDEĞER NO 1 Equivalent No 1	EŞDEĞER NO 2 Equivalent No 2	ÖLÇÜLER - MM. Dimensions - MM.					TİP Type	MALZEME Material
4047104	UNIMOG1300/1500/1700	ARKA AKS Rear Axle	0049971347	-	12011021	530.107	75,00	100,00		10,00		L3	NBR
410299	ACTROS-1831/35/40/43/48	ARKA AKS Rear Axle	0179976847	0179978447	01029129	01020678	90,00	110,00		10,00		L3L	NBR
410263	1313, 1313 4X4	ARKA AKS Rear Axle	0129979147	0119974247	12015406	562.874	100,00	125,00		13,00		L3L	NBR
412196	917/25 AF	ARKA AKS Rear Axle	0119975847	0099973947	12019646	12017368	110,00	130,00		12,00		L1L	NBR
412146	312-321 SERİSİ	ARKA AKS Rear Axle	0009977446	0089976246	12011404	612.103	110,00	140,00		13,00		SL	NBR
412190	327/1413/1513 SERİSİ327/1413/1513	ARKA AKS Rear Axle	-	-	-	-	115,00	150,00	-	15,00	-	L3	NBR
412171	ATECO-302-1513-1831-1513	ARKA AKS Rear Axle	0069970546	0079972546	12011405	044.679	120,00	145,00		15,00		SL	NBR
412326	1513-1831-1834-1840-1843	ARKA AKS Rear Axle	0109978147	0109978047	12015886	567.108	120,00	145,00		15,00		L13TL	NBR
412265	KAMYON VE ÇEKİCİ SERİSİ	ARKA AKS Rear Axle	004 997 1747	002 997 1847	12011418	010.901	120,00	150,00	-	15,00	-	SLL	NBR
412362-V	ATEGO KAMYON 1517-1518	ARKA AKS Rear Axle	0229975247	0239975947	01027682	451.100	125,00	150,00		14,00		SL13TL	FKM
412214	1513 L/LK SERİSİ	ARKA AKS Rear Axle	0069972147	0139975947	12014739	768.057	125,00	150,00		15,00		SL	NBR
412298	ATEGO-304-403-403-404-1517-1518	ARKA AKS Rear Axle	0159974647	-	12015501	210.294	125,00	150,00		15,00	13,00	L13TL SS-RL	NBR
412298-V	ATEGO-304-403-403-404-1517-1518	ARKA AKS Rear Axle	0169977747	-	19020065	457.620	125,00	150,00		15,00		L13TL SS-RL	FKM
415069	302-OTOBÜS 1513, 1517-322	ARKA AKS Rear Axle	0019973847	0029974046	12011406	044.687	125,00	152,40		15,00		SL	NBR
415239-V	CITARO-CONNECTO OTOBÜS-ZF MODEL AKS	ARKA AKS Rear Axle	0139975946	0239972647	12019945	-	130,00	170,00		18,00	20,00	SC12	FKM
415078	1425, 1428, 1429, 1442 4x2/4X4	ARKA AKS Rear Axle	0029973247	-	12011349	255.637	140,00	160,00		13,00		L1	NBR
415165	UNIMOG1300/1500/1700-747-1/2/3	ARKA AKS Rear Axle	0089975847	0169973347	01017574	-	142,50	175,00		13,00	16,00	L3TLL SS-RL	NBR
420063	ACTROS ÇEKİCİ	ARKA AKS Rear Axle	0159974947	-	01027787	147.730	145,00	175,00	205,00	9,00	14,00	SPL1L ABS	NBR

AKS GRUBU / Axle Group

SKT NO	KULLANILAN MODELLER Models	KULLANIM YERİ Place Of Use	ORJİNAL NO 1 Original No 1	ORJİNAL NO 2 Original No 2	EŞDEĞER NO 1 Equivalent No 1	EŞDEĞER NO 2 Equivalent No 2	ÖLÇÜLER - MM. Dimensions - MM.					TİP Type	MALZEME Material
415117-V	AXOR-ACTROS-1817-1821-1824-303-304	ARKA AKS Rear Axle	0139979447	0069972147	12014739	768.057	145,00	175,00		12,00	13,00	SL	FKM
415117	AXOR-ACTROS-1817-1821-1824-303-304	ARKA AKS Rear Axle	0119970146	0119971246	12011407	-	145,00	175,00		13,00		SL	NBR
415141	AXOR-ACTROS-1817-1821-1824-303-304	ARKA AKS Rear Axle	0039976647	0119974446	12011374	208.210	145,00	175,00		14,00		L1L	NBR
415172-V	AXOR-ACTROS-1817-1821-1824-303-304	ARKA AKS Rear Axle	0139978946	-	01016689	826.774	145,00	175,00		16,00		L13TLL SS-RL	FKM
420061-V	AXOR-ACTROS ÇEKİCİ-304-403 OTB.	ARKA AKS ABS'Lİ Rear Axle With ABS	0209970547	-	01019245	147.731	145,00	175,00	205,00	18,00	20,00	LL13TLSS-RL ABS	FKM
420017	1626-1632	ARKA AKS Rear Axle	3049971747	0099970046	12011099	563.617	185,00	210,00		13,00		L3T	NBR
417032	2220-2620 SERİSİ-LAK	ARKA AKS Rear Axle	0039974846	0079978246	346.640	-	165,00	190,00		13,00		L3	NBR
417094	26-35-40 SERİSİ	ARKA AKS Rear Axle	0059978447	-	12012576	327.247	170,00	190,00	-	8,50	9,50	L3L	NBR
4SP-004	304-404-TOURISMO	ARKA AKS (4TM-163 SACI) Rear Axle	3463560027	9463560127	19035979	-	147,20	173,70		1,50		SP	SAC
4H-498	AXOR-ACTROS-1817-1821-1824-303-304	ARKA AKS ORİNGİ Rear Axle O-ring	0169974048	0019976848	19019093	315.621	250,00	0,00		5,00		O	NBR
417116	AXOR-ACTROS-1513 LK SERİSİ	ARKA AKS DIŞ Rear Axle Outer	0169975647	0139970547	12014740	768.065	145,00	175,00		14,00	12,00	L13L	NBR
415205-V	AXOR-ACTROS-TRAVEGO HO 6 DİFR.	ARKA AKS DIŞ Rear Axle Outer	0139973546	-	01033415	451.110	145,00	175,00		15,00		L3T	FKM
045656-V	ACTROS ÇEKİCİ	ARKA AKS FREN MİLİ Rear Axle Brake Shaft	0129973747	0129973647	01017009	-	42,00	55,00		9,00		SPL1	FKM
045676-V	ACTROSS-RL-1835-1840-1843 1996 >	ARKA AKS FREN MİLİ Rear Axle Brake Shaft	0039970547	0099973046	01017010	010.197	42,00	58,00		7,00		L1	FKM
412263-V	MB100 KAMYON	ARKA AKS İÇ Rear Axle Inner	-	-	-	-	86,00	127,00	112,00	12,00	21,00	SPLSL	FKM
415206	AXOR-ACTROS-TRAVEGO HO 6 DİFR.	ARKA AKS İÇ Rear Axle Inner	0139973646	0149970546	01034120	451.130	145,00	175,00		8,00		SPL1	NBR
415222-V	AXOR-ACTROS ÇEKİCİ	ARKA AKS İÇ Rear Axle Inner	0209973947	0119975546	01019352	022.851	145,00	175,00		17,00	21,00	L13TLL SS-RL	FKM
417113	2629/1935-2635	ARKA AKS İÇ Rear Axle Inner	0159975847	0119971746	01019888	008.818	160,00	180,00		10,00		L13TL SS-RL	NBR

AKS GRUBU / Axle Group

SKT NO	KULLANILAN MODELLER Models	KULLANIM YERİ Place Of Use	ORJİNAL NO 1 Original No 1	ORJİNAL NO 2 Original No 2	EŞDEĞER NO 1 Equivalent No 1	EŞDEĞER NO 2 Equivalent No 2	ÖLÇÜLER - MM. Dimensions - MM.					TİP Type	MALZEME Material
415178	1317 A (970.362/363) 4x4, 1017	ARKA AKS KOVAN İÇ Rear Axle	0199979047	-	19032103	-	145,00	165,00		13,00		SL	NBR
4TM-056	2521-3021 EM (KEÇE+O-RİNG KISA SET)	ARKA AKS KEÇE TAM.TK. Rear Axle Repair Kit	6243560080 S	-	19030143	-						TM	-
4TM-156	2521-3021 EM (KEÇE+O-RİNG+CONTA - FULL SET)	ARKA AKS KEÇE TAM.TK. Rear Axle Repair Kit	6243560080	0089977545	19025771	315.621						TM	-
4TM-163	AXOR-ATECO-ACTROS-TRAVEGO SERİSİ (415205-V+415206)	ARKA AKS TAMİR TAKIMI Rear Axle Repair Kit	-	-	-	-						TM	-
4TM-106	TRAVEGO OTOBÜS (4TM-163+4SP-004)	ARKA AKS KEÇE TAM.TAK. Rear Axle Repair Kit	-	-	-	-						TM	-

DİFERANSİYEL GRUBU / Differential Group

SKT NO	KULLANILAN MODELLER Models	KULLANIM YERİ Place Of Use	ORJİNAL NO 1 Original No 1	ORJİNAL NO 2 Original No 2	EŞDEĞER NO 1 Equivalent No 1	EŞDEĞER NO 2 Equivalent No 2	ÖLÇÜLER - MM. Dimensions - MM.					TİP Type	MALZEME Material
046145-V	814 DA, 815 DA	MAHRUTİ (DİFER.ÖN) Differential - Front	0009975146	-	12011460	706.035	42,00	65,00		12,00		L3TL SAĞ -Right	FKM
045244	327/1413/1513 SERİSİ	MAHRUTİ (DİFER.ÖN) Differential - Front	0009976647	-	01002858	006.564	52,00	72,00		12,00		L3	NBR
047757-V	1935-2635	MAHRUTİ (DİFER.ÖN) Differential - Front	0169976847	0029971047	01016880	-	68,00	90,00		10,00		L13TL SS-RL	FKM
410318	ACTROS ÇEKİCİ 1831-1840-1843-3224	MAHRUTİ (DİFER.ÖN) Differential - Front	0129977047	0099974546	12012573	000.559	72,00	105,00		13,00		L1L	NBR
410318-V	ACTROS ÇEKİCİ 1831-1840-1843-3224	MAHRUTİ (DİFER.ÖN) Differential - Front	0139974947	0109973746	12012573	008.745	72,00	105,00		13,00		L1L	FKM
410320-V	3-113 SERİSİ	MAHRUTİ (DİFER.ÖN) Differential - Front	0109973746	0119976847	12014743	000.745	72,00	105,00		13,00		SL	FKM
410396-VN	ACTROS ÇEKİCİ-1817-1821-1834-2524-AXOR- ECONIC	MAHRUTİ (DİFER.ÖN) Differential - Front	0209970647	-	01026188	023.330	72,00	105,00		19,00		SPL13L SS-RL	FKM+NBR
047272	1920 LP/LPS SERİSİ	MAHRUTİ (DİFER.ÖN) Differential - Front	0009975046	-	12011201	-	75,00	95,00	-	10,00	-	L3	NBR
412363-VN	ATEGO KAMYON 1517-1518	MAHRUTİ (DİFER.ÖN) Differential - Front	0189977647	-	01030117	221.710	78,00	135,00		12,00	21,50	SPL13L SS-RL	FKM+NBR

DİFERANSİYEL GRUBU / Differential Group

SKT NO	KULLANILAN MODELLER Models	KULLANIM YERİ Place Of Use	ORJİNAL NO 1 Original No 1	ORJİNAL NO 2 Original No 2	EŞDEĞER NO 1 Equivalent No 1	EŞDEĞER NO 2 Equivalent No 2	ÖLÇÜLER - MM. Dimensions - MM.					TİP Type	MALZEME Material
410397	1935-2635-3031	MAHRUTİ (DİFER.ÖN) Differential - Front	0179972847	-	01029595	198.430	85,00	105,00		13,00		L13TL SS-RL	NBR
410356-V	ACTROS SERİSİ	MAHRUTİ-TAHRİKLİ AKS Differential	0109973646	0109975446	12012549	008.680	85,00	105,00		13,00		L1	FKM
410397-V	1935-2635-3031	MAHRUTİ (DİFER.ÖN) Differential - Front	0179972947	-	01029594	198.440	85,00	105,00		13,00		L13TL SS-RL	FKM
410450-V	AXOR KAMYON 2523-2528-3228-3240	MAHRUTİ (DİFER.ÖN) Differential - Front	0149971246	-	01017056	504.560	85,00	110,00		12,00	17,00	L13LLR	FKM
412327-VN	AXOR-ATECO-3028	MAHRUTİ (DİFER.ÖN) Differential - Front	9423530159	-	12019701	NA5238	85,00	120,00		10,00	21,00	SLL13TL SS-RL	FKM+NBR
412321-VN	AXOR-ACTROS-1840-304-403	MAHRUTİ (DİFER.ÖN) Differential - Front	0159974747	0219975947	01017059	447.080	85,00	145,00		12,00	37,00	SPL13L SS-RL	FKM+NBR
415199-VN	AXOR-ACTROS-TRAVEGO HO 6 DİFR.	MAHRUTİ (DİFER.ÖN) Differential - Front	0219978547	0239977947	01027938	220.660	85,00	155,00		12,00	33,00	SPL13TLLR SAĞ-Right	FKM+NBR
410489-V	CONNECTO OTOBÜS	MAHRUTİ (DİFER.ÖN) Differential - Front	0239972747	-	01029710	-	90,00	125,00		12,00	19,00	L3TLR SAĞ -Right	FKM
047047	1735, 1929, 1935, 1945, 1948, 2529	MAHRUTİ -DIŞ Differential Outside	0179972647	0179974847	01020465	008.304	68,00	90,00		10,00		L3	NBR
047758-V	2517-1817-1821-1824-303-304-403-404	MAHRUTİ-İÇ Differential - Inner	0169976747	0059976847	01016877	830.798	68,00	85,00		10,00		L13TL SAĞ -Right	FKM
047756-V	AXOR KAMYON 2523-2528-3228-3240	MAHRUTİ-İÇ Differential - Inner	0179973147	0079974747	01019480	451.140	75,00	95,00		10,00		L13TL SS-RL	FKM
047047-V	NG-SK SERİSİ	MAHRUTİ-GEÇİT DİFR. Middle Rear AXLE	0029971047	0169976847	01016880	198.420	68,00	90,00		10,00		L3	FKM
047434	33372-26321	MAHRUTİ-GEÇİT DİFR. Middle Rear AXLE	0079978446	0099970746	01025712	008.354	80,00	100,00		12,00		L1L	NBR

ŞANZIMAN GRUBU / Gearbox Group

SKT NO	KULLANILAN MODELLER Models	KULLANIM YERİ Place Of Use	ORJİNAL NO 1 Original No 1	ORJİNAL NO 2 Original No 2	EŞDEĞER NO 1 Equivalent No 1	EŞDEĞER NO 2 Equivalent No 2	ÖLÇÜLER - MM. Dimensions - MM.					TİP Type	MALZEME Material
046021-VK	MB800	ŞANZIMAN ÖN Gearbox Front	0229972947	0734310396	01029649	12019650	40,00	52,00		8,50		L3TL SAĞ -Right	FKM +YÜN-NW
046022-V	1817-1821-1824-2521-303-304-ATEGO AXOR-ACTRO	ŞANZIMAN ÖN Gearbox Front	0159970447	0089971947	12015259	283.827	46,00	64,00		8,00		L13TL SAĞ -Right	FKM
045827-V	1817-1821-1824-ATECO-AXOR-ZF 9S75-109	ŞANZIMAN ÖN Gearbox Front	0219971247	-	20016209	586.676	48,00	65,00		10,00		L13TL SAĞ -Right	FKM
045880-V	303-ZF S6-90	ŞANZIMAN ÖN Gearbox Front	0079975447	-	12011306	284.662	48,00	69,00		10,00		L1 SAĞ-Right	FKM
045840-V	2628 S 6X4-ZF 16S-130	ŞANZIMAN ÖN Gearbox Front	0049940747	0079975447	12011307	033.472	48,00	75,00		8,00		L1 SAĞ-Right	FKM
045964-V	AXOR-ACTROS-ATEGO-TRAVEGO-TOUR- ISMO	ŞANZIMAN ÖN Gearbox Front	0159970647	0119976247	12018806	141.960	52,00	68,00		8,00		L13TL SAĞ -Right	FKM
046027-V	ATEGO-AXOR-1838-2524-2527 ZF 16S-151	ŞANZIMAN ÖN Gearbox Front	0734310104	-	12018806	141.960	52,00	68,00		8,00		L3T SAĞ -Right	FKM
045851-V	1735-2628 S 6X4-ZF 16S-151-160	ŞANZIMAN ÖN Gearbox Front	0049976946	0079972247	12011308	284.645	55,00	75,00		8,00		L1 SAĞ-Right	FKM
046115-P	KAMYON SERİSİ	ŞANZIMAN ÖN Gearbox Front	0239979447	-	01031969	515.340	55,00	75,00		8,00	9,20	L1R SAĞ -Right	ACM
046020-V	AXOR-ACTROS-ATEGO-304-403-404- TRAVEGO	ŞANZIMAN ÖN Gearbox Front	0199970647	0199970547	12019647	220.900	56,00	72,00		8,00		L13TL SAĞ -Right	FKM
045330	1626-1632-S6-90	ŞANZIMAN ÖN Gearbox Front Outer	0079972147	-	12011331	040.991	48,00	65,00		10,00		L1	NBR
045702	2226, 2232 6x2/6x4	ŞANZIMAN ÖN İÇ Gearbox Front	0079972147	-	12011331	040.991	48,00	65,00		10,00		L1L	NBR
047741-P	ATECO-1317	ŞANZIMAN ÖN İÇ Gearbox Front	0219972547	0139972646	01033903	456.970	55,00	80,00		8,00		L3TLR SAĞ -Right	ACM
047049	2628 S 6X4-ZF 16S-130	ŞANZIMAN ÖN İÇ Gearbox Front	0039976847	0039976847	12011015	-	70,00	90,00		10,00		L3	NBR
045361	322 SERİSİ	ŞANZIMAN ARKA Gearbox Rear	0099975147	6504035100	12010908	258.407	35,00	52,00		10,00		L3L	NBR
045226-V	3228, 3244, 3250, 3538, 3544, 3550	ŞANZIMAN ARKA Gearbox Rear	0089975047	0109979147	01019886	-	40,00	60,00		10,00		L3L	FKM
046103-V	ACTROS-1831-1835-1840	ŞANZIMAN ARKA Gearbox Rear	0139977145	-	12017069	-	50,00	65,00		10,00		L3TL	FKM
045636	2220-2620 SERİSİ	ŞANZIMAN ARKA Gearbox Rear	0079972347	0049970946	12011333	041.335	55,00	75,00		10,00		L1	NBR

ŞANZIMAN GRUBU / Gearbox Group

SKT NO	KULLANILAN MODELLER Models	KULLANIM YERİ Place Of Use	ORJİNAL NO 1 Original No 1	ORJİNAL NO 2 Original No 2	EŞDEĞER NO 1 Equivalent No 1	EŞDEĞER NO 2 Equivalent No 2	ÖLÇÜLER - MM. Dimensions - MM.					TİP Type	MALZEME Material
045477	0309-1513 L/LK SERİSİ	ŞANZIMAN ARKA Gearbox Rear	0089971146	-	01003273	043.932	58,00	75,00		12,00		SL	NBR
047647-V	CONECTO-TOURINO	ŞANZIMAN ARKA Gearbox Rear	-	-	12014424	-	65,00	85,00		13,00	9,50	L3L SOL-Left	FKM
047581	1922-1925-2222-2622	ŞANZIMAN ARKA Gearbox Rear	0109979647	0079979546	12011410	246.891	70,00	90,00		10,00		SLL	NBR
047859-V	AXOR-ATEGO-TRAVEGO-ZF 9S75	ŞANZIMAN ARKA Gearbox Rear	0239978847	-	01033293	-	80,00	100,00		15,50		L13LL SOL -Left	FKM
410227	2220-2620 SERİSİ	ŞANZIMAN ARKA Gearbox Rear	0049970646	0119974347	12011340	556.807	85,00	105,00		10,00		L1	NBR
410348-V	1626-1632-56-90/S5-110-GP	ŞANZIMAN ARKA Gearbox Rear	0049972246	0099975947	12013757	033.464	85,00	105,00		10,00		L1 SOL-Left	FKM
410435-V	KAMYON-ÇEKİCİ	ŞANZIMAN ARKA Gearbox Rear	0189978648	-	20034608	-	90,00	125,00		12,00		L3TL SOL -Left	FKM
410121	3025-303-ZF 56-90	ŞANZIMAN ARKA Gearbox Rear	5108159	-	12011055	-	100,00	120,00		12,00		L3	NBR
412344-V	1622-1625-1628-1733-2225-2425-2428	ŞANZIMAN ARKA Gearbox Rear	0219976447	-	01016923	490.840	105,00	130,00		12,00		L13TL SOL -Left	FKM
047684-V	ATECO	ŞANZIMAN ARKA-DIŞ Gearbox Rear - Outer	0159978247	0139977746	12035746	-	55,00	80,00		8,00		L3L	FKM
047343-V	2628 S 6X4-ZF 16S-130	ŞANZIMAN ARKA-DIŞ Gearbox Rear - Outer	0079979546	0109972446	12011533	246.891	70,00	90,00		10,00		L1 SOL-Left	FKM
047650-V	AXOR-ATEGO ZF 9S75	ŞANZIMAN ARKA-DIŞ Gearbox Rear - Outer	0179972547	0079979847	19016678	587.966	80,00	100,00		8,00		L3TL SOL -Left	FKM
047521	1224-1226-1227-1228-1231-1234	ŞANZIMAN ARKA-DIŞ Gearbox Rear - Outer	0179977947	0089970047	01020468	104.320	80,00	100,00		10,00		L1L	NBR
410426-V	1844-ACTROS	ŞANZIMAN ARKA-DIŞ Gearbox Rear - Outer	0149971947	-	01002889	457.450	90,00	115,00	-	14,00	-	L13TL SS-RL	FKM
410281	AXOR-ACTROS ÇEKİCİ	ŞANZIMAN ARKA-DIŞ Gearbox Rear - Outer	0149971947	0139977247	01002889	-	95,00	115,00		13,00		SL	NBR
410402	1735, 1929, 1935, 1945, 1948, 2529-1844-AC-TROS	ŞANZIMAN ARKA-DIŞ Gearbox Rear - Outer	0149971947	0139975547	01002889	457.450	95,00	115,00		13,00		L13TL SS-RL	NBR
410402-V	2529-1844-ACTROS-ATEGO-AXOR-TOUR-ISMO	ŞANZIMAN ARKA-DIŞ Gearbox Rear - Outer	0139977247	0199975547	01002889	457.450	95,00	115,00		13,00		L13TL SS-RL	FKM
410451-V	AXOR-ACTROS-TRAVEGO-TOURISMO	ŞANZIMAN ARKA-DIŞ Gearbox Rear - Outer	0239971647	0159977846	01029684	222.830	95,00	115,00		15,50		L13LL SOL -Left	FKM

ŞANZIMAN GRUBU / Gearbox Group

SKT NO	KULLANILAN MODELLER Models	KULLANIM YERİ Place Of Use	ORJİNAL NO 1 Original No 1	ORJİNAL NO 2 Original No 2	EŞDEĞER NO 1 Equivalent No 1	EŞDEĞER NO 2 Equivalent No 2	ÖLÇÜLER - MM. Dimensions - MM.					TİP Type	MALZEME Material
412019	2628 S 6X4-ZF 16S-130	ŞANZIMAN ARKA-DIŞ Gearbox Rear - Outer	0634309117	-	01001450	-	105,00	130,00		13,00		SL	NBR
410376-V	AXOR-ACTROS-TRAVEGO-TOURISMO	ŞANZIMAN ARKA-DIŞ Gearbox Rear - Outer	0159974247	0139975647	01017136	141.950	95,00	115,00		13,00		L13TL SOL -Left	FKM
412290-V	2628 S 6X4-ZF 16S-130	ŞANZIMAN ARKA-DIŞ Gearbox Rear - Outer	0219976447	-	01016923	490.840	105,00	130,00		11,00		L13L SOL -Left	FKM
412092-V	AXOR-ATEGO-ECONIC	ŞANZIMAN ARKA-DIŞ Gearbox Rear - Outer	0179977347	0139978646	12032089	-	115,00	140,00		12,00		L3	FKM
412100	2628 S 6X4-ZF 16S-130	ŞANZIMAN ARKA-DIŞ Gearbox Rear - Outer	0634309117	-	12011062	282.200	105,00	130,00	-	13,00	-	L3	NBR
047711-V	AXOR-ATEGO-TRAVEGO-ZF 9S75	ŞANZIMAN ARKA Gearbox Rear	0179972547	0079979847	01020467	587.966	80,00	100,00		10,00		L13TL SS-RL	FKM
410386-V	1419 4x4	ŞANZIMAN ARKA Gearbox Rear	0089973347	0049970647	12013757	033.464	85,00	105,00		10,00		L3TL SOL -Left	FKM
040769	KAMYON-ÇEKİCİ SERİSİ	VİTES SEÇİCİ MİLİ Gear Selection Shaft	003 997 8747	-	-	-	12,00	20,00	-	5,00	-	L1	NBR
040844	1735, 1929, 1935, 1945, 1948, 2529	VİTES SEÇİCİ MİLİ Gear Selection Shaft	0069974946	-	12014616	038.083	25,00	35,00	-	6,00	-	L3BTL	NBR
040267	2220-2620 SERİSİ	ŞANZIMAN MİLİ Gearbox Axle	0059975846	3760020100	12011115	12010824	20,00	32,00		7,00		L3	NBR
040287	UNIMOĞ1300/1500/1700-UST MİLİ	ŞANZIMAN MİLİ Gearbox Axle	0009971147	-	12000157	227.609	32,00	45,00		7,00		L3	NBR
045660	1513 L/LK SERİSİ	KARDAN MİLİ SİSTEMİ Propeller Shaft	0079977446	-	-	-	36,00	54,00		7,00		L1	NBR
045229	312-321 SERİSİ	KARDAN MİLİ SİSTEMİ Propeller Shaft	0059978546	0009972247	12010971	418.501	50,00	72,00		10,00		L3	NBR
046171-V	AXOR-ACTROS VOITH TİP	RETARDER MİLİ Retarder Axle	H457300	-	-	-	55,00	70,00		7,00		L3B	FKM
046172-V	AXOR-ACTROS VOITH TİP	RETARDER MİLİ Retarder Axle	H457300	-	-	-	55,00	70,00		8,00	21,00	SPL3B	FKM
047887-V	TRAVEGO - ECONIC OTOBÜS (VOITH R115)	RETARDER MİLİ Retarder Axle	0209971347	-	12019242	-	60,00	80,00		7,50	21,00	SPL3B	FKM
047886-V	TRAVEGO - ECONIC OTOBÜS (VOITH R115)	RETARDER MİLİ Retarder Axle	0209971247	-	12019243	065.490	60,00	80,00		7,50		L3B	FKM
412322-V	303-304-403 SERİSİ - VOITH-115-R	RETARDER MİLİ Retarder Axle	0089978447	-	01033427	NA5269	115,00	140,00		10,00		L3B	FKM

ŞANZIMAN GRUBU / Gearbox Group

SKT NO	KULLANILAN MODELLER Models	KULLANIM YERİ Place Of Use	ORJİNAL NO 1 Original No 1	ORJİNAL NO 2 Original No 2	EŞDEĞER NO 1 Equivalent No 1	EŞDEĞER NO 2 Equivalent No 2	ÖLÇÜLER - MM. Dimensions - MM.					TİP Type	MALZEME Material
4TM-103	AXOR-ATECO-ACTROS (046171-V+046172-V)	RETARDER KEÇE TM.TK. Retarder Sys.Seal Rep. Kit	H457300	-	-	-						TM	
4TM-104	TRAVEGO-ECONIC SERİSİ (047886-V + 047887-V) Voith Retarde R115	RETARDER KEÇE TM.TK. Retarder Sys.Seal Rep. Kit	-	-	-	-						TM	
4TM-107	AXOR-ATECO-ACTROS (046171-V+046172-V+PTFE RING)	RETARDER KEÇE TM.TK. Retarder Sys.Seal Rep. Kit	H457300	-	-	-						TM	
4TM-108	AXOR-ATECO-ACTROS (046171-V+046172-V+PTFE RING+...)	RETARDER SIZD. TM.TK. Retarder Seal Kit	H457300	-	-	-						TM	
040774-V	ZF 9S75 ŞANZ. KULLANILAN MOD.	ŞANZIMAN KLM.ÇIKIŞ MİLİ Speedometer Shaft	0039979846	-	01002259	010.804	10,00	15,00		3,00		SPL5	FKM
040182	1626-1632-56-90	ŞANZ. DEBRİYAJ KEÇESİ Clutch Shaft Seal	0019978346	-	12010784	164.500	14,00	24,00		7,00		L3	NBR
045744-V	ACTROS-1831/35/40/43/48	PTO MİLİ Power Take Off Shaft	0089978547	-	01034643	12014056	45,00	62,00		10,00	8,00	L1L	FKM
046209-V	AXOR-ATEGO-NK-SK SERİSİ	ŞANZIMAN PTO KEÇESİ Gearbox PTO	0139976846	0109977246	01012588	-	52,00	72,00		8,00		L3T	FKM
040278	TOURINO-CONECTO ZFS5-42	ŞANZ. DEBRİYAJ KEÇESİ Clutch Shaft Seal	0009972546	0079975846	12010836	01034676	22,00	35,00		7,00		L3	NBR
040713	FULLER ŞANZ.	ŞANZ. DEBRİYAJ KEÇESİ Clutch Shaft Seal	0229972847	-	12002188	120.103	22,00	35,00		7,00		L3L	NBR
040149	1626-1632-56-90/S5-110-GP	ŞANZ. DEBRİYAJ KEÇESİ Clutch Shaft Seal	0069974946	-	12014616	038.083	25,00	35,00		7,00		L3	NBR
040745	1817-1821-1824-ZF 9S-75	ŞANZ. DEBRİYAJ KEÇESİ Clutch Shaft Seal	0099979746	0119974746	12011122	038.075	25,00	35,00		7,00		L3TL	NBR
041174	85-151	ŞANZ. DEBRİYAJ KEÇESİ Clutch Shaft Seal	0049976347	-	12010846	125.208	25,00	35,00		7,00		L3	NBR
040610	1622-1625-1628-1733-2225-2425-2428	ŞANZ. DEBRİYAJ KEÇESİ Clutch Shaft Seal	0109977346	0029973846	12011127	12010865	26,00	37,00		7,00		L3L	NBR
045812-S	ACTROS-1831/35/40/43/48	ŞANZ. DEBRİYAJ KEÇESİ Clutch Shaft Seal	0129978247	0189975647	01026706	221.970	40,00	52,00		7,00		L1L SS-RL	VMQ
045059	1920 LP/LPS SERİSİOM.346	ŞANZ. DEBRİYAJ KEÇESİ Clutch Shaft Seal	0039971646	-	12010944	040.320	42,00	60,00		10,00		L3	NBR
045753-P	UNIMOG1300/1500/1700	ŞANZ. DEBRİYAJ KEÇESİ Clutch Shaft Seal	0239975447	0239978747	01031902	-	42,00	62,00		8,00		LL3T	ACM
041110-V	ZF 9S109-16S109TİP ŞANZ.	ŞANZIMAN KULESİ Gearbox Tower	0750112047	-	01029805	-	22,00	36,00	48,00	14,50		SPL3CTL	FKM

ŞANZIMAN GRUBU / Gearbox Group

SKT NO	KULLANILAN MODELLER Models	KULLANIM YERİ Place Of Use	ORJİNAL NO 1 Original No 1	ORJİNAL NO 1 Original No 2	EŞDEĞER NO 1 Equivalent No 1	EŞDEĞER NO 1 Equivalent No 2	ÖLÇÜLER - MM. Dimensions - MM.					TİP Type	MALZEME Material
041111-V	1817-1821-1824-ZF 9S-75	ŞANZIMAN KULESİ Gearbox Tower	0501316333	-	01032393	-	22,00	36,00	57,00	14,50		SPL3CTL	FKM
041051-V	-	ŞANZIMAN KULESİ Gearbox Tower	0002670697	-	12015769	457.290	25,00	38,00	49,50	14,50		SPL3TL	FKM
4P-262-V	MB800-ATECO 1517	ŞANZIMAN PİSTON KEÇESİ Gearbox U Packing Seal	0002670997	0750112089	504.540	5045400	53,00	63,00		16,20		PCX4	FKM
4P-326-H	AXOR-ACTROS-ECONIC-1840-G210-G240-G221	ŞANZ. AKTAR. PİSTONU Gearbox Piston	0249978347	-	175.480	-	80,00	90,00		17,00		LS	HNBR
4P-260-H	ZF 9S75 ŞANZ.	TAKVİYE PİSTON KEÇESİ Reinforcement Piston Seal	0002671918	0734309378	12014452	-	63,00	16,00		10,50		LS	HNBR

DİREKSİYON GRUBU / Steering Group

SKT NO	KULLANILAN MODELLER Models	KULLANIM YERİ Place Of Use	ORJİNAL NO 1 Original No 1	ORJİNAL NO 1 Original No 2	EŞDEĞER NO 1 Equivalent No 1	EŞDEĞER NO 1 Equivalent No 2	ÖLÇÜLER - MM. Dimensions - MM.					TİP Type	MALZEME Material
040541	1513-1844 L/LK SERİSİZ TIP	DİREKSİYON MİLİ Steering Shaft	0770198002	-	12011381	-	17,00	28,00		8,00		L1X	NBR
041178-H	AXOR-ACTROS	DİREKSİYON MİLİ Steering Shaft	0239971947	0004600300	01029608	-	28,00	40,00		5,50	7,00	L3BL	HNBR
041179	ATEGO KAMY ON1517-1518-2521-2524-403-404	DİREKSİYON MİLİ Steering Shaft	0149976947	-	01020082	237.744	28,00	40,00		8,00		L3BLL	NBR
040758	322 SERİSİ ZF TIP	DİREKSİYON MİLİ Steering Shaft	0009970246	-	12001680	-	30,00	40,00		7,00		L3BTL	NBR
045380	312-321 SERİSİ	DİREKSİYON MİLİ Steering Shaft	-	-	01002057	-	38,00	52,00		10,00		L3	NBR
045559	1620 LP	DİREKSİYON MİLİ Steering Shaft	-	-	-	-	50,00	72,00		8,00	-	L1	NBR

DİREKSİYON GRUBU / Steering Group

SKT NO	KULLANILAN MODELLER Models	KULLANIM YERİ Place Of Use	ORJİNAL NO 1 Original No 1	ORJİNAL NO 2 Original No 2	EŞDEĞER NO 1 Equivalent No 1	EŞDEĞER NO 2 Equivalent No 2	ÖLÇÜLER - MM. Dimensions - MM.					TİP Type	MALZEME Material
4TM-098	AXOR-ACTROS (041178-H + SEGMAN)	DİREKSİYON MİLİ Steering Shaft Repair Kit	0239971947	-	-	-						TM	-
041159-V	ESKİ MODELLER - ZF TİP POMPA	DİREKSİYON POMPA Steering Pump	0770 080 437	-	-	-	20,00	35,00	-	8,00	-	L13XT	FKM
040743	UNIMOG1300/1500/1700-ZF-8033	DİREKSİYON KUTUSU Steering Box	0059973747	0089979447	12014826	006.408	26,00	37,00		7,00	8,00	L3BTL	NBR
040744	302-303-1626-1632-UNIMOG	DİREKSİYON KUTUSU Steering Box	0029974446	0119977246	01020082	237.744	28,00	40,00		7,00	8,00	L3BTL	NBR
045930	1513 L/LK SERİSİZF TİP	HİDROLİK DİREKSİYON SİST. Hydraulic Steering System	8060033101	-	12001698	01031633	45,00	62,00		7,00		L3BTL	NBR

MOTOR GRUBU / Engine Group

SKT NO	KULLANILAN MODELLER Models	KULLANIM YERİ Place Of Use	ORJİNAL NO 1 Original No 1	ORJİNAL NO 2 Original No 2	EŞDEĞER NO 1 Equivalent No 1	EŞDEĞER NO 2 Equivalent No 2	ÖLÇÜLER - MM. Dimensions - MM.					TİP Type	MALZEME Material
047730-V	CANTER FE 304-449	KRANK ÖN Crank Shaft Front	013384	-	-	-	55,00	78,00		8,00		LL3T SAĞ -Right	FKM
047767-VK	CANTER FE 515-519-635-639-659	KRANK ÖN Crank Shaft Front	ME017208	-	19035864	-	56,00	78,00	84,00	11,50	16,00	SPL2LR	FKM
417115-S	CANTER FE 515-519-635-639-659	KRANK ARKA Crank Shaft Rear	ME240010	-	-	-	100,00	123,00	158,00	14,00		SPL5R	VMQ
415179-V	CANTER FE 304-449	KRANK ARKA Crank Shaft Rear	-	-	-	-	100,00	158,00	7,00	141,00	14,50	SPL1L SOL -Left	FKM
45-039-V	CANTER FE 515-519-639-659	SUPAP Valve Stem Seal	-	-	-	-	8,00	16,00		13,50		LSY1	FKM
45-017-V	MARATON V8-275	SUPAP Valve Stem Seal	ME061574	-	-	-	11,90	17,00	18,60	10,00	15,00	LSY1	FKM
040873	CANTER FE 304-FE 449	MARŞ MOTORU Starter Engine	ME701024	-	BF306	-	18,70	30,00		4,50		L5	NBR

AKS GRUBU / Axle Group

SKT NO	KULLANILAN MODELLER Models	KULLANIM YERİ Place Of Use	ORJİNAL NO 1 Original No 1	ORJİNAL NO 2 Original No 2	EŞDEĞER NO 1 Equivalent No 1	EŞDEĞER NO 2 Equivalent No 2	ÖLÇÜLER - MM. Dimensions - MM.					TİP Type	MALZEME Material
047728	CANTER FE 304-515-519-639-959	ÖN AKS Front Axle	327029	-	-	-	56,00	81,00		8,00		L1L	NBR
047550	CANTER FE 635	ÖN AKS Front Axle	-	-	12016141	12012575	68,00	90,00		13,00		L1L	NBR
047729	CANTER FE 449-FE 659	ÖN AKS Front Axle	MB025295	-	VKS6451	-	72,00	94,00		10,00		L1L	NBR
412257	MARATON V8-275	ÖN AKS Front Axle	MH034092	-	-	-	130,00	150,00		14,00		L1L	NBR
415181	SAFİR	ÖN AKS Front Axle	MH034180	-	-	-	140,00	158,00		11,00		L13TL	NBR
412303	CANTER FE 449-FE 659	ARKA AKS Rear Axle	MB308965	-	19035300	-	85,00	127,00		13,00		SPSLL	NBR
415152	MARATON V8-275 - SAFİR	ARKA AKS PORYA Rear Axle	MC807438	-	-	-	155,00	172,00		14,00		L1L	NBR
410378	CANTER FE 304-515-519-635-639-959	ARKA AKS PORYA DIŞ Rear Axle Outer	MB308933	-	VKS6429	-	46,00	102,00		10,00	16,00	SPL3	NBR

AKS GRUBU / Axle Group

SKT NO	KULLANILAN MODELLER Models	KULLANIM YERİ Place Of Use	ORJİNAL NO 1 Original No 1	ORJİNAL NO 2 Original No 2	EŞDEĞER NO 1 Equivalent No 1	EŞDEĞER NO 2 Equivalent No 2	ÖLÇÜLER - MM. Dimensions - MM.					TİP Type	MALZEME Material
410379	CANTER FE 449-FE 659	ARKA AKS PORYA DIŞ Rear Axle Outer	MB308966	-	VKS6475	-	56,00	114,00		10,00		SPL3	NBR
410377	CANTER FE 304-515-519-635-639-959	ARKA AKS PORYA İÇ Rear Axle Inner	MB161152	-	19019081	-	70,00	112,00		10,00	18,50	SPL1L	NBR
045795	MARATON V8-275	ARKA AKS KOVAN İÇ Rear Axle	MH034079	-	-	-	60,00	72,00		8,00		L3L	NBR
045470	MARATON V8-275	ARKA AKS KOVAN İÇ Rear Axle	MH034079	-	-	-	60,00	72,00	-	10,00	-	L3	NBR
040703	MARATON V8-275	ARKA AKS FREN MİLİ Rear Axle Brake Shaft	MC815684	-	-	-	40,00	49,00		6,00		LL5	NBR
045790	MARATON V8-275	ARKA AKS FREN MİLİ Rear Axle Brake Shaft	MC804949	19016498	-	-	40,00	52,00		5,00		L5	NBR

DİFERANSİYEL GRUBU / Differential Group

SKT NO	KULLANILAN MODELLER Models	KULLANIM YERİ Place Of Use	ORJİNAL NO 1 Original No 1	ORJİNAL NO 2 Original No 2	EŞDEĞER NO 1 Equivalent No 1	EŞDEĞER NO 2 Equivalent No 2	ÖLÇÜLER - MM. Dimensions - MM.					TİP Type	MALZEME Material
047732-P	CANTER FE 304-515-519-635-639-959	MAHRUTİ (DİFER.ÖN) Differential - Front	MH034213	-	-	-	52,00	84,00		14,00		L1L SS-RL	ACM
047731-P	CANTER FE 449-FE 659	MAHRUTİ (DİFER.ÖN) Differential - Front	MH034205	-	-	-	56,00	99,00	81,00	10,00	34,00	SPL1LR SS-RL	ACM

ŞANZİMAN GRUBU / Gearbox Group

SKT NO	KULLANILAN MODELLER Models	KULLANIM YERİ Place Of Use	ORJİNAL NO 1 Original No 1	ORJİNAL NO 2 Original No 2	EŞDEĞER NO 1 Equivalent No 1	EŞDEĞER NO 2 Equivalent No 2	ÖLÇÜLER - MM. Dimensions - MM.					TİP Type	MALZEME Material
040287	CANTER FE 449	ŞANZİMAN ÖN Gearbox Front	MH034067	44881597	12000157	227609	32,00	45,00		7,00		L3	NBR
040877-P	CANTER FE 304-449	ŞANZİMAN ÖN Gearbox Front	ME622400	-	19016672	-	34,00	50,00		7,00		L3L SAÇ -Right	ACM
045681-P	CANTER FE515-519-635-659	ŞANZİMAN ÖN Gearbox Front	ME642211	-	01033472	01030363	40,00	58,00		8,00		L3L SAÇ -Right	ACM

ŞANZIMAN GRUBU / Gearbox Group

SKT NO	KULLANILAN MODELLER Models	KULLANIM YERİ Place Of Use	ORJİNAL NO 1 Original No 1	ORJİNAL NO 1 Original No 2	EŞDEĞER NO 1 Equivalent No 1	EŞDEĞER NO 1 Equivalent No 2	ÖLÇÜLER - MM. Dimensions - MM.				TİP Type	MALZEME Material	
045681-S	CANTER FE515-519-635-659	ŞANZIMAN ÖN Gearbox Front	ME642211	-	19026206	01030363	40,00	58,00		8,00		L3L SAĞ -Right	VMQ
045897-P	CANTER FE 304	ŞANZIMAN ARKA Gearbox Rear	-	-	-	-	48,00	65,00		9,00		L1L SOL-Left	ACM
045770	CANTER FE 449	ŞANZIMAN ARKA Gearbox Rear	-	-	12000519	096.091	48,00	65,00		10,00		L3L	NBR
045967-P	CANTER FE 515-519-635-639-659	ŞANZIMAN ARKA Gearbox Rear	MH034181	-	-	-	50,00	65,00		9,00		L3L SOL-Left	ACM

DİREKSİYON GRUBU / Steering Group

SKT NO	KULLANILAN MODELLER Models	KULLANIM YERİ Place Of Use	ORJİNAL NO 1 Original No 1	ORJİNAL NO 1 Original No 2	EŞDEĞER NO 1 Equivalent No 1	EŞDEĞER NO 1 Equivalent No 2	ÖLÇÜLER - MM. Dimensions - MM.				TİP Type	MALZEME Material	
040927	CANTER FE 449-FE 659	HİD.DİREK.POMPASI Power Steering Pump	-	-	-	-	20,00	34,00		8,00		L3X	NBR

MOTOR GRUBU / Engine Group

SKT NO	KULLANILAN MODELLER Models	KULLANIM YERİ Place Of Use	ORJİNAL NO 1 Original No 1	ORJİNAL NO 2 Original No 2	EŞDEĞER NO 1 Equivalent No 1	EŞDEĞER NO 2 Equivalent No 2	ÖLÇÜLER - MM. Dimensions - MM.					TİP Type	MALZEME Material
047868-V	FL912-913 MOT. MİDİBÜS SERİSİ	KRANK ÖN Crank Shaft Front	02234133	04150782	12012095	-	65,00	85,00		13,00		SPL1L SAĞ -Right	FKM
410491-VK	1013 TİP MOT. MİDİBÜS SERİSİ	KRANK ÖN Crank Shaft Front	04253373	20412568	01027762	084.920	81,00	104,00		11,00		L13TL SAĞ -Right	FKM +YÜN-NW
412364-V	FL912-913 MOT. MİDİBÜS SERİSİ	KRANK ARKA Crank Shaft Rear	042300392	04232267	20020867	-	115,00	140,00		13,50		SPL3TL SOL -Left	FKM
412384-VAEK	1013 TİP MOT. MİDİBÜS SERİSİ	KRANK ARKA Crank Shaft Rear	04253333	20412286	01027763	NA5475	130,00	150,00		13,00		L3TL SOL -Left	FKM+AEM+ YÜN-NW
45-041-V	FL912-913-1013 MOT. MİDİBÜS SERİSİ	SUPAP Valve Stem Seal	04153728	-	12015512	-	8,00	12,00	15,50	9,50		LSY4T	FKM
45-051-V	FL912-913-1013 MOT. MİDİBÜS SERİSİ	SUPAP Valve Stem Seal	04179944	-	49472020	143.930	8,00	12,00	15,20	9,50		LSY2T	FKM

AKS GRUBU / Axle Group

SKT NO	KULLANILAN MODELLER Models	KULLANIM YERİ Place Of Use	ORJİNAL NO 1 Original No 1	ORJİNAL NO 2 Original No 2	EŞDEĞER NO 1 Equivalent No 1	EŞDEĞER NO 2 Equivalent No 2	ÖLÇÜLER - MM. Dimensions - MM.					TİP Type	MALZEME Material
046106-V	SULTAN SERİSİ	ÖN AKS Front Axle	83A1105022AA	-	-	-	50,80	69,80		12,00		L3TLL	FKM
045395	ATLAS KAMYON E5-E6 8,5 TON	ÖN AKS DIŞ Front Axle Outer	-	-	-	-	45,00	72,00		12,00		L3	NBR
047497	ATLAS KAMYON E5-E6 8,5 TON	ARKA AKS Rear Axle	-	-	-	-	70,00	90,00		10,00	12,00	L3LL	NBR
047863-H	ASKERİ ARAÇ	ARKA AKS Rear Axle	-	-	-	-	50,00	78,00	-	9,00	14,50	SC6	HNBR
410431-V	COBRA 4X4 - SULTAN OTOBÜSS-RLERİSİ	ARKA AKS Rear Axle	83A1105020AA	-	-	-	89,00	107,70		12,00		L3TLL	FKM
410390-V	SULTAN-DORUK MİDİBÜS - OTOBÜS SERİSİ	ARKA AKS DIŞ Rear Axle Outer	13C0205260AA	-	-	-	56,00	112,00		8,00	10,00	SPL3	FKM
410357	ATLAS KAMYON E5-E6 8,5 TON	ARKA AKS DIŞ Rear Axle Outer	9828-57103-A	-	-	-	57,00	124,00		13,00	15,00	SPLL3	NBR
412308-V	SULTAN SERİSİ	ARKA AKS DIŞ Rear Axle Outer	12E0005050AA	-	-	-	70,00	148,00		11,50		SPL1L	FKM
412263-V	SULTAN-DORUK MİDİBÜS - OTOBÜS SERİSİ	ARKA AKS İÇ Rear Axle Inner	13C025060AA	-	-	-	86,00	127,00	112,00	12,00	21,00	SPLSL	FKM

AKS GRUBU / Axle Group

SKT NO	KULLANILAN MODELLER Models	KULLANIM YERİ Place Of Use	ORJİNAL NO 1 Original No 1	ORJİNAL NO 2 Original No 2	EŞDEĞER NO 1 Equivalent No 1	EŞDEĞER NO 2 Equivalent No 2	ÖLÇÜLER - MM. Dimensions - MM.					TİP Type	MALZEME Material
412263	SULTAN-DORUK MİDİBÜS - OTOBÜS SERİSİ	ARKA AKS İÇ Rear Axle Inner	13C025060AA	-	-	-	86,00	127,00	112,00	12,00	21,00	SPLSL	NBR
412307	SULTAN SERİSİ	ARKA AKS İÇ Rear Axle Inner	12A1405032AA	-	-	-	120,00	140,00		10,00	7,50	L3BTL	NBR
412284	ATLAS KAMYON E5-E6 8,5 TON	ARKA AKS İÇ Rear Axle Inner	9828-01203-A	-	-	-	127,00	147,00		11,00		LL1	NBR
412353-V	ZF AKSLI MODELLER	ARKA AKS RULMANI Rear Axle Bearing Seal	16N00-05707-AA	-	-	-	125,00	148,00		7,00	9,70	SPLL135S-RL	FKM
412354-V	ZF AKSLI MODELLER	ARKA AKS RULMANI Rear Axle Bearing Seal	16N00-05706-AA	-	-	-	125,00	148,30	156,00	8,10	9,30	SC	FKM
4TM-089	ZF AKSLI MODELLER (412353-V+412354-V+4MH-425)	ARKA AKS TAMİR TAKIMI Rear Axle Repair Kit	3095043	3095042	19037007	735.540						TM	-
4TM-162	ZF AKSLI MODELLER (412353-V+412354-V)	ARKA AKS TAMİR TAKIMI Rear Axle Repair Kit	3095043	3095042	19037007	-						TM	-

ŞANZİMAN GRUBU / Gearbox Group

SKT NO	KULLANILAN MODELLER Models	KULLANIM YERİ Place Of Use	ORJİNAL NO 1 Original No 1	ORJİNAL NO 2 Original No 2	EŞDEĞER NO 1 Equivalent No 1	EŞDEĞER NO 2 Equivalent No 2	ÖLÇÜLER - MM. Dimensions - MM.					TİP Type	MALZEME Material
047647-V	SULTAN-DORUK MİDİBÜS-OTOBÜS SERİSİ	ŞANZİMAN ARKA Gearbox Rear	5000824292	X13711	12014424	6.46910	65,00	85,00		13,00	9,50	L13L SOL -Left	FKM

DİĞER ÜRÜNLER / Other Parts

SKT NO	KULLANILAN MODELLER Models	KULLANIM YERİ Place Of Use	ORJİNAL NO 1 Original No 1	ORJİNAL NO 2 Original No 2	EŞDEĞER NO 1 Equivalent No 1	EŞDEĞER NO 2 Equivalent No 2	ÖLÇÜLER - MM. Dimensions - MM.					TİP Type	MALZEME Material
4P-049	SULTAN SERİSİ	HAVALI KAPI PİSTON KEÇESİ Air Door Piston	-	-	-	-	12,00	60,00		27,00		PCX3	NBR

MOTOR GRUBU / Engine Group

SKT NO	KULLANILAN MODELLER Models	KULLANIM YERİ Place Of Use	ORJİNAL NO 1 Original No 1	ORJİNAL NO 2 Original No 2	EŞDEĞER NO 1 Equivalent No 1	EŞDEĞER NO 2 Equivalent No 2	ÖLÇÜLER - MM. Dimensions - MM.					TİP Type	MALZEME Material
046195-FPK	MAJOR-R SERİLERİ	KRANK ÖN Crank Shaft Front	5010550614	5000684699	20031971	344.480	60,00	75,00		10,00		F2TL SAĞ -Right	PTFE+ACM +YÜN-NW
417107-V	8140-MASCOT	KRANK ÖN Crank Shaft Front	7701044093	-	12016918	199.220	70,00	159,00	179,00	16,00		SPL1L SAĞ -Right	FKM
047498-S	R310	KRANK ÖN Crank Shaft Front	5000787287	-	19031102	-	80,00	100,00		13,00		L1L SAĞ -Right	VMQ
410491-VK	PREMIUM-MIDLUM DEUTZ 1013 MOT	KRANK ÖN Crank Shaft Front	7420412568	04253373	01027762	084.920	81,00	104,00		11,00		L13TL SAĞ -Right	FKM +YÜN-NW
410472-FPK	PREMIUM-MAGNUM-KERAX-MIDLUM	KRANK ÖN Crank Shaft Front	5003087031-	5000670508	15026914	453.930	90,00	110,00	-	11,00	-	F25TL SAĞ -Right	PTFE+ACM +YÜN-NW
410471-FPK	PREMIUM-MAGNUM-KERAX-MIDLUM	KRANK ÖN Crank Shaft Front	5010295829	5010550791	20029789	243.550	90,00	120,00	-	13,00	-	F25TL SAĞ -Right	PTFE+ACM +YÜN-NW
410473-V	F8L-BF714	KRANK ÖN Crank Shaft Front	0024472539	-	01016938	-	95,00	120,00	-	12,00	-	L3TL	FKM
415240-FPK	KERAX-MAGNUM--PREMIUM-RVI MOT.	KRANK ÖN Crank Shaft Front	7485108423	-	20036083	000.270	136,00	159,00		13,00		F2TK SAĞ -Right	PTFE+ACM +YÜN-NW
417108-V	8140-MASCOT	KRANK ARKA Crank Shaft Rear	7701044092	5001860798	12016920	199.230	114,00	171,00	177,00	13,00		SPL1L SS-RL	FKM
412384-VAEK	PREMIUM-MIDLUM DEUTZ 1013 MOT	KRANK ARKA Crank Shaft Rear	7420412286	04253333	01027763	NA5475	130,00	150,00		13,00		L3TL SOL -Left	FKM+AEM +YÜN-NW
417134-FPK	RVI MOT. - KERAX-PREMIUM	KRANK ARKA Crank Shaft Rear	7408148259	-	19037091	-	150,00	180,00		15,00		F25TK SOL -Left	PTFE+ACM +YÜN-NW
415230-FPK	PREMIUM-MAGNUM-KERAX-MIDLUM	KRANK ARKA Crank Shaft Rear	5003087029-	5010359807	20026913	457.220	150,00	172,00	-	13,00	-	F25TL SOL -Left	PTFE+ACM +YÜN-NW
417126-FPK	PREMIUM-MAGNUM-KERAX-MIDLUM	KRANK ARKA Crank Shaft Rear	5003087029-	5010295831	20029788	233.530	160,00	190,00	-	13,00	-	F25TL SOL -Left	PTFE+ACM +YÜN-NW
045990-V	MASCOT	EKSANTRİK MİLİ Cam Shaft	7701035740	-	12014728	419.730	55,00	70,00		8,00		L13TL SAĞ -Right	FKM
45-026-V	DX1 3-MASCOT	SUPAP Valve Stem Seal	7701064021	-	19026181	012.150	7,00	11,00		11,50		LSY4T	FKM
45-021-V	DX1 - 11/12-PREMIUM-MAGNUM	SUPAP Valve Stem Seal	7420864662	7400859171	12035707	-	8,00	10,80	14,20	9,00		LSY2T	FKM
45-030-V	8140-MIDLUM-MASCOT-PREMIUM	SUPAP Valve Stem Seal	7701040023	5000809085	12015512	104.380	8,00	12,00	15,20	9,50		LSY2T	FKM
45-035-V	MAJOR-R340 TI	SUPAP Valve Stem Seal	5001859093	-	12014524	453.650	12,00	16,00	20,00	15,00		LSY2T	FKM

MOTOR GRUBU / Engine Group

SKT NO	KULLANILAN MODELLER Models	KULLANIM YERİ Place Of Use	ORJİNAL NO 1 Original No 1	ORJİNAL NO 2 Original No 2	EŞDEĞER NO 1 Equivalent No 1	EŞDEĞER NO 2 Equivalent No 2	ÖLÇÜLER - MM. Dimensions - MM.					TİP Type	MALZEME Material
040942-V	EUROCARGO-150	YAKIT POMPASI Fuel Pump	5000294951	5001833971	12019586	-	20,00	31,00		7,30		L13TL	FKM
045372	KAMYON SERİSİ	YAKIT POMPASI Fuel Pump	5001848037	-	12010860	12011126	25,00	52,00	-	7,00	-	L3	NBR
040844-V	KAMYON SERİSİ	HAVA KOMPRESÖRÜ Air Compressor	5001826534	-	01026501	01034100	25,00	35,00		6,00		L3BTL	FKM

AKS GRUBU / Axle Group

SKT NO	KULLANILAN MODELLER Models	KULLANIM YERİ Place Of Use	ORJİNAL NO 1 Original No 1	ORJİNAL NO 2 Original No 2	EŞDEĞER NO 1 Equivalent No 1	EŞDEĞER NO 2 Equivalent No 2	ÖLÇÜLER - MM. Dimensions - MM.					TİP Type	MALZEME Material
410258	R340 TI-MIDLINER	ÖN AKS Front Axle	0024472286	-	07016683	-	100,00	120,00		12,00		L3TLL	NBR
410263	R340 TI	ÖN AKS Front Axle	5010067534	0024472569	12014731	12015406	100,00	125,00		13,00		L3L	NBR
412010	ESKİ MODEL	ÖN AKS Front Axle	5000675159	5516015599	12011065	12017368	110,00	130,00	-	13,00	-	L3	NBR
412285	MIDLUM	ÖN AKS Front Axle	5010443189	-	12016441	457.710	120,00	150,00		15,00		L13TL SS-RL	NBR
040970	MASCOT-MIDLINER	ÖN AKS KİNG PİMİ Front Axle King Pin	5010439191	-	01030541	-	28,00	35,00		4,00		L5	NBR
040536	MIDLUM-MIDLINER	ÖN AKS KİNG PİMİ Front Axle King Pin	5010439192	-	12016519	-	35,00	42,00		4,00		L5	NBR
045675	MIDLUM	ÖN AKS KİNG PİMİ Front Axle King Pin	5010439194	5000439732	01025733	01029642	45,00	52,00		4,00		L5	NBR
045973	PREMIUM-MAGNUM-KERAX-MIDLUM	ÖN AKS KİNG PİMİ Front Axle King Pin	5010439195	5003087037	01012190	-	50,00	58,00		4,00		L2	NBR
047756-V	MASCOT-MIDLINER	ARKA AKS Rear Axle	5010319684	-	01019480	451.140	75,00	95,00		10,00		L13TL SS-RL	FKM
415255-V	C-G-KERAX-MAGNUM-MJOR MIDLUM-PREMIUM	ARKA AKS Rear Axle	5010566199	-	12014707	12019138	120,00	160,00		15,00	16,00	L13TLL SS-RL	FKM
415226	PREMIUM-MAGNUM-KERAX-MIDLUM	ARKA AKS Rear Axle	5000788490	0024472667	01016684	081.570	120,00	160,00	-	15,00	16,00	L3TLL	NBR

AKS GRUBU / Axle Group

SKT NO	KULLANILAN MODELLER Models	KULLANIM YERİ Place Of Use	ORJİNAL NO 1 Original No 1	ORJİNAL NO 1 Original No 2	EŞDEĞER NO 1 Equivalent No 1	EŞDEĞER NO 1 Equivalent No 2	ÖLÇÜLER - MM. Dimensions - MM.				TİP Type	MALZEME Material	
415117	KAMYON SERİSİ	ARKA AKS Rear Axle	5000281014	-	12011407	-	145,00	175,00		13,00		SL	NBR
415141	KAMYON SERİSİ	ARKA AKS Rear Axle	5000281015	-	12011374	208.210	145,00	175,00		14,00		L1L	NBR
412393-V	YENİ MOD. (FAG RULMAN İÇİN)	ÖN-ARKA AKS RULMANI Front-Rear Axle Bearing	356014382 SET	-	0293 V30	-	125,00	142,00		8,00	9,20	SC	FKM
045676-V	KAMYON SERİSİ	ARKA AKS FREN MİLİ Rear Axle Brake Shaft	5000284157	-	01017010	010.197	42,00	58,00		7,00		L1	FKM

DİFERANSİYEL GRUBU / Differential Group

SKT NO	KULLANILAN MODELLER Models	KULLANIM YERİ Place Of Use	ORJİNAL NO 1 Original No 1	ORJİNAL NO 1 Original No 2	EŞDEĞER NO 1 Equivalent No 1	EŞDEĞER NO 1 Equivalent No 2	ÖLÇÜLER - MM. Dimensions - MM.				TİP Type	MALZEME Material	
045706-V	MASCOT-MIDLINER-MESS-RENGER	MAHRUTİ (DİFER.ÖN) Differential - Front	5000786509	-	07034632	-	50,00	72,00		10,00	8,00	L3L	FKM
412388-V	MAGNUM-MIDLUM-PREMIUM	MAHRUTİ (DİFER.ÖN) Differential - Front	7420832385	7422468905	01031695	-	110,23	145,00		10,00	12,00	SPSC10	FKM
410450-V	MAGNUM	MAHRUTİ (DİFER.ÖN) Differential - Front	5010319134	5010319135	01017056	504.560	85,00	110,00		12,00	17,00	L13LLR	FKM

ŞANZİMAN GRUBU / Gearbox Group

SKT NO	KULLANILAN MODELLER Models	KULLANIM YERİ Place Of Use	ORJİNAL NO 1 Original No 1	ORJİNAL NO 1 Original No 2	EŞDEĞER NO 1 Equivalent No 1	EŞDEĞER NO 1 Equivalent No 2	ÖLÇÜLER - MM. Dimensions - MM.				TİP Type	MALZEME Material	
046087-V	MASCOT 5S 200/270	ŞANZİMAN ÖN Gearbox Front	5001847619	-	12029812	-	35,00	64,00		9,00		L13TL SAĞ -Right	FKM
046021-VK	MIDLUM ZFS5-42	ŞANZİMAN ÖN Gearbox Front	5001856970	-	01029649	12019650	40,00	52,00		8,50		L3TL SAĞ -Right	FKM +YÜN-NW
045827-V	PREM..MIDLUM ZF9S75-16S109-EATON 4106-8209	ŞANZİMAN ÖN Gearbox Front	5000819719	5000824252	20016209	586.676	48,00	65,00		10,00		L13TL SAĞ -Right	FKM
045840-V	330.26 SERİSİ	ŞANZİMAN ÖN Gearbox Front	5000283802	5000803107	12011307	033.472	48,00	75,00		8,00		L1 SAĞ-Right	FKM
045990-V	MIDLUM 9S-110	ŞANZİMAN ÖN Gearbox Front	5001868096	-	12015120	419.730	55,00	70,00		8,00		L13TL SAĞ -Right	FKM

ŞANZIMAN GRUBU / Gearbox Group

SKT NO	KULLANILAN MODELLER Models	KULLANIM YERİ Place Of Use	ORJİNAL NO 1 Original No 1	ORJİNAL NO 2 Original No 2	EŞDEĞER NO 1 Equivalent No 1	EŞDEĞER NO 2 Equivalent No 2	ÖLÇÜLER - MM. Dimensions - MM.					TİP Type	MALZEME Material
045851-V	PREMIUM-MAGNUM-KERAX ZF85-151-165-151	ŞANZIMAN ÖN Gearbox Front	5001847325	5001865529	12011308	284.645	55,00	75,00		8,00		L1 SAÇ-Right	FKM
046115-P	MAGNUM-PREMIUM-ZF85-151-165 SERİSİ	ŞANZIMAN ÖN Gearbox Front	0734310387	-	01031969	515.340	55,00	75,00		8,00		L1 SAÇ-Right	ACM
047751-V	MAGNUM-PREMIUM 440-480-R340 T1 VT241-2B	ŞANZIMAN ÖN Gearbox Front	7420476025	-	01030098	435.820	64,90	90,00		10,00		SPL5	FKM
045880-V	S6-85-F16 MIDLINER	ŞANZIMAN ÖN Gearbox Front	5000590828	-	12011306	284.662	48,00	69,00		10,00		L1 SAÇ-Right	FKM
046011	PREMIUM-MAGNUM ZF 9S75 - 9S109 ŞANZ.	ŞANZIMAN ÖN Gearbox Front	0501311146	-	01017792	-	60,00	74,80		4,70		SPL5	NBR
046086-V	MASCOT 5S 200/270	ŞANZIMAN ARKA Gearbox Rear	5001847628	-	12029813	-	40,00	52,00		9,00		L3TL SOL -Left	FKM
047647-V	PREMIUM-MIDLUM-MIDLINER	ŞANZIMAN ARKA Gearbox Rear	5000824292	-	12014424	-	65,00	85,00		13,00	9,50	L3L SOL-Left	FKM
047839-VAE	KAMYON-ÇEKİCİ SERİSİ ZF 5S-421	ŞANZIMAN ARKA Gearbox Rear	-	-	20027594	12014636	70,00	90,00	-	10,00	-	L3TL SOL -Left	FKM+AEM
047645-V	MAGNUM EATON 8209-420 19T	ŞANZIMAN ARKA Gearbox Rear	5001836249	-	12013860	034.347	78,00	100,00		10,00		L13TL SOL -Left	FKM
047650-V	PREMIUM - MIDLUM ZF 9S75	ŞANZIMAN ARKA Gearbox Rear	750111334	-	01020467	587.966	80,00	100,00		8,00		L3TL SOL -Left	FKM
047711-V	PREMIUM - MIDLUM ZF 9S75	ŞANZIMAN ARKA Gearbox Rear	0750111334	-	01020467	587.966	80,00	100,00		10,00		L13TL SS-RL	FKM
410227	390 SERİSİ	ŞANZIMAN ARKA Gearbox Rear	5000250088	5000587182	12011340	556.807	85,00	105,00		10,00		L1	NBR
410386-V	-	ŞANZIMAN ARKA Gearbox Rear	5000240135	5000802711	12013757	033.464	85,00	105,00		10,00		L3TL SOL -Left	FKM
410341-V	MAGNUM EATON.8209	ŞANZIMAN ARKA Gearbox Rear	7700619238	7700718505	12012579	702.994	90,00	110,00		12,00		L13TL SOL -Left	FKM
412315-V	MAGNUM VT241 2B-440-480	ŞANZIMAN ARKA Gearbox Rear	7401652776	-	12016675	-	90,00	145,00		10,00		L13TL SOL -Left	FKM
410219-V	MAGNUM-PREMIUM B9-B18-340 T1	ŞANZIMAN ARKA Gearbox Rear	5010242655	5003087025	12015304	-	95,00	120,00		13,00		L1L SOL-Left	FKM
410368-V	MAJOR R - FULLER RTOX-R340 T1	ŞANZIMAN ARKA Gearbox Rear	5001831130	5000814109	12012235	967.850	95,30	114,29		11,88		L13TL SS-RL	FKM
410403-V	PREMIUM-MAGNUM-MIDLUM-KERAX ZF 9S/16S109	ŞANZIMAN ARKA Gearbox Rear	5001850333	5001850333	01026691	-	105,00	125,00		12,00	9,50	L13TL SOL -Left	FKM

ŞANZIMAN GRUBU / Gearbox Group

SKT NO	KULLANILAN MODELLER Models	KULLANIM YERİ Place Of Use	ORJİNAL NO 1 Original No 1	ORJİNAL NO 2 Original No 2	EŞDEĞER NO 1 Equivalent No 1	EŞDEĞER NO 2 Equivalent No 2	ÖLÇÜLER - MM. Dimensions - MM.				TİP Type	MALZEME Material	
412344-V	PREMIUM-MAGNUM ZF 8S / 16S 151	ŞANZIMAN ARKA Gearbox Rear	5000289673	-	01016923	490.840	105,00	130,00		12,00		L13TL SOL -Left	FKM
045820-V	8140-MASCOT	ŞANZIMAN YARDIMCI MİLİ Gearbox Auxiliary Shaft	7701042340	-	12014726	419.660	50,00	70,00		10,00		L3TL SS-RL	FKM
047830-P	MAGNUM ZF 16S 151-181	ŞANZIMAN YARDIMCI MİLİ Gearbox Auxiliary Shaft	5001831661	-	01017789	-	77,00	95,30		6,00		L5	ACM
040774-V	B9- B9A-R340TI	ŞANZIMAN KLM.ÇIKIŞ MİLİ Speedometer Shaft	0024472657	5000056491	01002259	010.804	10,00	15,00		3,00		SPL5	FKM
040520	ESKİ MODELLER	ŞANZIMAN KLM.ÇIKIŞ MİLİ Speedometer Shaft	7701006169	-	01002914	-	18,00	30,00		7,00		L1L	NBR
045768-P	MAGNUM-MIDLUM-KERAX-PREMIUM	PTO MİLİ Power Take Off Shaft	5001859800	-	12010967	-	50,00	68,00		8,00		L3TL	ACM
047684-V	KERAX-MAGNUM-PREMIUM ZF 16S151-1300	PTO MİLİ Power Take Off Shaft	5000803548	-	01026471	-	55,00	80,00		8,00		L3L	FKM
040182	MIDLINER-G SERİSİ	ŞANZ. DEBRİYAJ KEÇESİ Clutch Shaft Seal	5001860239	0024417804	12010784	164.500	14,00	24,00		7,00		L3	NBR
040592	PREMIUM-MAGNUM-MIDLUM ZF8S/16S151	ŞANZ. DEBRİYAJ KEÇESİ Clutch Shaft Seal	5001853396	-	12011114	-	20,00	30,00		7,00		L3L	NBR
040591	MIDLINER	ŞANZ. DEBRİYAJ KEÇESİ Clutch Shaft Seal	5000241665	-	01002918	-	22,00	32,00		7,00		L3L	NBR
040713	FULLER RTOX-R340 TI	ŞANZ. DEBRİYAJ KEÇESİ Clutch Shaft Seal	5000242594	-	12002188	120.103	22,00	35,00		7,00		L3L	NBR
040278	MIDLUM-MIDLINER ZF55-42	ŞANZ. DEBRİYAJ KEÇESİ Clutch Shaft Seal	5000294202	-	12010836	01034676	22,00	35,00		7,00		L3	NBR
040465	PREMIUM-MAGNUM ZF8S-151-16S-151	ŞANZ. DEBRİYAJ KEÇESİ Clutch Shaft Seal	5001830956	-	12011487	038.083	25,00	35,00		7,00		L1L	NBR
040745	PREMIUM-MAGNUM-MIDLUM EATON 4106-8210	ŞANZ. DEBRİYAJ KEÇESİ Clutch Shaft Seal	5001860153	-	12011122	038.075	25,00	35,00		7,00		L3TL	NBR
041174	8S-151-MAGNUM 420	ŞANZ. DEBRİYAJ KEÇESİ Clutch Shaft Seal	5001861999	-	12010846	125.208	25,00	35,00		7,00		L3	NBR
041177	PREMIUM-MAGN.-MIDL.EATON 4106-8209- ZF 9S75	ŞANZ. DEBRİYAJ KEÇESİ Clutch Shaft Seal	5000824272	5000240259	12014616	038.083	25,00	35,00		7,00		L13TL	NBR
041109-V	PREMIUM-MAGNUM ZF 16S151	ŞANZIMAN KULESİ Gearbox Tower	0501306439	-	12015769	457.290	25,00	38,00	49,50	14,50		SPL3CTL	FKM
041108-NL	PREMIUM-MAGNUM-MIDLUM-KERAX ZF8S-16S	ŞANZ. DEBRİYAJ KEÇESİ Clutch Shaft Seal	5001853240	7485113941	01030095	-	28,00	42,00		11,00		SPL13TLL	NBR+TPU

ŞANZİMAN GRUBU / Gearbox Group

SKT NO	KULLANILAN MODELLER Models	KULLANIM YERİ Place Of Use	ORJİNAL NO 1 Original No 1	ORJİNAL NO 2 Original No 2	EŞDEĞER NO 1 Equivalent No 1	EŞDEĞER NO 2 Equivalent No 2	ÖLÇÜLER - MM. Dimensions - MM.				TİP Type	MALZEME Material	
4MH-415-H	TÜM MODELLER ZF 16S 151	VİTES KUMANDA KULESİ Gear Control System	5001843026	-	01034594	-	55,00	63,00		9,40		L	HNBR
4FM-112-CA	MAGNUM EATON 8209	ŞANZ. DEBRİYAJ KEÇESİ Clutch Shaft Seal	X8875532	-	-	-	65,00	70,00		2,10		L KARE	PTFE
040844	KERAX-MIDLUM-PREMIUM	VİTES SEÇİCİ MİLİ Gear Selection Shaft	5000240259	5000283659	12014616	038.083	25,00	35,00	-	6,00	-	L3BTL	NBR
041113	PREMIUM-MAGNUM-KERAX -ZF-16S-SERİSİ	ŞANZ. DEBRİYAJ KEÇESİ Clutch Shaft Seal	5001842902	5010439193	12015561	01026544	30,00	37,00		4,00		L2T	NBR
041111-V	PREMIUM - MIDLUM ZF 9S75 ŞANZ.	ŞANZİMAN KULESİ Gearbox Tower	0501316333	-	01032393	-	22,00	36,00	57,00	14,50		SPL3CTL	FKM
041106-V	KAMYON SERİSİ	ŞANZİMAN KULESİ Gearbox Tower	5001843024	-	01029609	733.480	25,00	40,00	49,00	15,00		SPL13CTL	FKM
4P-228-H	ZF 16S 151-181-221-2220-2221-2521-2330-2331 ŞANZ.	ŞANZ. AKTAR. PİSTONU Gearbox Piston	5001843136	0734307294	49378203	-	50,00	90,00		7,50		PC	HNBR
4P-262-V	MIDLUM-PREMIUM 9S109-16S109-130-150-151-181-221 ŞANZ.	ŞANZİMAN PİSTON KEÇESİ Gearbox U Packing Seal	5000289803	0750112089	504.540	5045400	53,00	63,00		16,20		PCX4	FKM

DİREKSİYON GRUBU / Steering Group

SKT NO	KULLANILAN MODELLER Models	KULLANIM YERİ Place Of Use	ORJİNAL NO 1 Original No 1	ORJİNAL NO 2 Original No 2	EŞDEĞER NO 1 Equivalent No 1	EŞDEĞER NO 2 Equivalent No 2	ÖLÇÜLER - MM. Dimensions - MM.				TİP Type	MALZEME Material	
045364	MIDLINER	DİREKSİYON MİLİ Steering Shaft	0851852700	-	01000210	-	38,00	55,00		10,00		L3	NBR
040743	MIDLINER	DİREKSİYON KUTUSU Steering Box	5000807996	-	12014826	006.408	26,00	37,00		7,00	8,00	L3BTL	NBR

MOTOR GRUBU / Engine Group

SKT NO	KULLANILAN MODELLER Models	KULLANIM YERİ Place Of Use	ORJİNAL NO 1 Original No 1	ORJİNAL NO 2 Original No 2	EŞDEĞER NO 1 Equivalent No 1	EŞDEĞER NO 2 Equivalent No 2	ÖLÇÜLER - MM. Dimensions - MM.				TİP Type	MALZEME Material	
047594-S	SCANIA 112-113-142-144	KRANK ÖN Crank Shaft Front	3386430	275591	12011821	-	80,00	100,00		10,00		L3TL SAĞ -Right	VMQ
047498-V	111-112-143-93-94-144 H SERİSİ	KRANK ÖN Crank Shaft Front	338643	275591	12011821	-	80,00	100,00		13,00		L1L SAĞ -Right	FKM
412385-FP	4-F-K-P-G-R-T-124 DC12-DSC12 MOT.	KRANK ÖN Crank Shaft Front	1392708	-	19036491	152320	120,00	140,00		12,00		F25TL SAĞ -Right	PTFE+ACM
415194-V	93-94-111-112-113-143-144-DS9-DS12-DS906-DS908	KRANK ARKA Crank Shaft Rear	3663036	231938	12013893	587.070	130,00	160,00		15,00		L13TL SOL -Left	FKM
415233-FPK	4-F-K-P-G-R-T-124 DC12-DSC12 MOT.	KRANK ARKA Crank Shaft Rear	1433183	1375002	15026917	090.510	145,00	175,00		13,00		F2TK SOL -Left	PTFE+ACM +YÜN-NW
417131-FPK	P-G-R-T-DC9-DC11-DC12-DC16-D12	KRANK ARKA Crank Shaft Rear	1757903	-	19037056	904820	145,00	185,00		13,00		F2TK SOL -Left	PTFE+ACM +YÜN-NW
040869	141-142 V8-143 E- R143-3 SERİSİ	EKSANTRİK MİLİ Cam Shaft	11098696	368076	12014828	15070400	30,00	47,00		10,00		L3TL	NBR
040745-V	DS9-DS906-908-93-113-143-4-164 SERİSİ	YAKIT POMPASI Fuel Pump	1926005	192600	12011122	038.075	25,00	35,00		7,00		L3TL	FKM
040850	DS9-DS906-908-93-113-143 SERİSİ	YAKIT POMPASI Fuel Pump	2807592	8194388	01001681	11014231	30,00	42,00		6,00	6,50	L3BTL	NBR
045735	143 V8 DSC 13	YAKIT POMPASI Fuel Pump	32201	-	12010899	258.407	32,00	52,00		10,00		L3L	NBR
045382	110 D-10	YAKIT POMPASI Fuel Pump	132672	-	12010911	-	35,00	58,00		10,00		L3	NBR

AKS GRUBU / Axle Group

SKT NO	KULLANILAN MODELLER Models	KULLANIM YERİ Place Of Use	ORJİNAL NO 1 Original No 1	ORJİNAL NO 2 Original No 2	EŞDEĞER NO 1 Equivalent No 1	EŞDEĞER NO 2 Equivalent No 2	ÖLÇÜLER - MM. Dimensions - MM.				TİP Type	MALZEME Material	
047104	142 SERİSİ	ÖN AKS Front Axle	33352	333520	12011021	530.107	75,00	100,00		10,00		L3	NBR
412318	SCANIA 93-113-P/R-113-143-3 SERİSİ	ÖN AKS Front Axle	3750874	375087	12014464	-	110,00	140,00		15,00		L3TL SS-RL	NBR
412062	111-112 H SERİSİ	ÖN AKS Front Axle	1733203	173320	12011073	325.511	117,47	143,18		12,70		L3	NBR
412170	124	ÖN AKS Front Axle	1392708	-	19036491	152.320	120,00	140,00		12,00		L1L	NBR

AKS GRUBU / Axle Group

SKT NO	KULLANILAN MODELLER Models	KULLANIM YERİ Place Of Use	ORJİNAL NO 1 Original No 1	ORJİNAL NO 2 Original No 2	EŞDEĞER NO 1 Equivalent No 1	EŞDEĞER NO 2 Equivalent No 2	ÖLÇÜLER - MM. Dimensions - MM.					TİP Type	MALZEME Material
045226-V	3-4-93-114-124 SERİSİ	ARKA AKS Rear Axle	1120864	-	01033114	-	40,00	60,00		9,00		L3L	FKM
410484	P-G-R-4 ÇEKİCİ SERİLERİ	ARKA AKS Rear Axle	1313719	1409890	12017173	222.610	75,00	100,00		10,00	13,00	SPSC	NBR
047544	G93-113-143-94-124-144 SERİSİ	ARKA AKS Rear Axle	333526	33352	12011021	530.107	75,00	100,00		10,00		L3L	NBR
412317	92-G93-113M-R113-143H-R143-144CGL	ARKA AKS Rear Axle	2979995	297999	12014734	586.781	112,00	136,80	131,00	7,50	10,50	SPL2	NBR
415196	G93-93M-113M-113E-113M-R113-143E-R143-	ARKA AKS Rear Axle	3509841	350984	01015140	-	125,00	160,00		15,50	20,00	SC5	NBR
415196-V	G93-93M-113M-113E-113M-R113-143E-R143-3	ARKA AKS Rear Axle	3509841	350984	01015140	-	125,00	160,00		15,50	20,00	SC5	FKM
415239-V	4-K-N SERİSİ ZF AKSLİ MODELLERİ	ARKA AKS Rear Axle	1415136	1438136	12019945	-	130,00	170,00		18,00	20,00	SC12	FKM
415224	94-114-124-125-144-164-G-R- SERİSİ	ARKA AKS Rear Axle	1740992	1409889	12020496	222.620	142,00	170,00		15,00	16,00	SC6	NBR
417086-V	93-111-112-113-142-143	ARKA AKS Rear Axle	3700756	291463	12011917	-	155,00	180,00		24,00	29,00	L1R SS-RL	FKM
415193	G93-93M-113M-113E-113M-R113-143E-R143-144	ARKA AKS İÇ Rear Axle Inner	3700747	297991	12012241	586.803	137,00	161,92		15,00	20,00	L1LR SS-RL	NBR
415192	93--111-112-113-P/R 113-143-124-144 SERİSİ	ARKA AKS İÇ Rear Axle Inner	3700762	291076	12011388	586.838	145,00	170,00		15,00	20,00	L1LR SS-RL	NBR
417046	93-111-112-113-P/R 113-143	ARKA AKS İÇ Rear Axle Inner	1594969	159496	12011092	325.503	150,81	177,80		12,70		L3	NBR

DİFERANSİYEL GRUBU / Differential Group

SKT NO	KULLANILAN MODELLER Models	KULLANIM YERİ Place Of Use	ORJİNAL NO 1 Original No 1	ORJİNAL NO 2 Original No 2	EŞDEĞER NO 1 Equivalent No 1	EŞDEĞER NO 2 Equivalent No 2	ÖLÇÜLER - MM. Dimensions - MM.					TİP Type	MALZEME Material
046020-V	4-114 SERİSİ	DİFR. SAĞ-SOL ÇIKIŞ Differential Output	1342766	-	01034654	-	56,00	72,00		8,00		L13TL SAĞ -Right	FKM
410320-V	3-113 SERİSİ	MAHRUTİ (DİFER.ÖN) Differential - Front	386968	-	12014743	000.745	72,00	105,00		13,00		SL	FKM
047498-V	DS11-DS14 ZF 9S75	MAHRUTİ (DİFER.ÖN) Differential - Front	3386430	275591	12011821	-	80,00	100,00		13,00		L1L SAĞ -Right	FKM

DİFERANSİYEL GRUBU / Differential Group

SKT NO	KULLANILAN MODELLER Models	KULLANIM YERİ Place Of Use	ORJİNAL NO 1 Original No 1	ORJİNAL NO 2 Original No 2	EŞDEĞER NO 1 Equivalent No 1	EŞDEĞER NO 2 Equivalent No 2	ÖLÇÜLER - MM. Dimensions - MM.					TİP Type	MALZEME Material
047753-P	93-113-143	MAHRUTİ (DİFER.ÖN) Differential - Front	3887288	124268	12015254	042.463	80,00	100,00		13,00	15,00	SLLL SS-RL	ACM
410465-VP	P-G-R-T-4-94-124-144-164 ÇEKİCİ SERİLERİ	MAHRUTİ (DİFER.ÖN) Differential - Front	1383129	1386594	12018653	222.630	85,00	105,00		12,00	18,00	SPSC SAĞ -Right	FKM+ACM
410265-V	111-112 H SERİSİ	MAHRUTİ (DİFER.ÖN) Differential - Front	2140085	214008	12002888	12011412	90,00	110,00		13,00		SLL	FKM
410489-V	-	MAHRUTİ (DİFER.ÖN) Differential - Front	1415130	-	01029710	-	90,00	125,00		12,00	19,00	L3TLR SAĞ -Right	FKM
410466-VP	P-G-R-T-4-94-124-144-164 ÇEKİCİ SERİLERİ	DİFERANSİYEL ARKA Differential Rear	1300974	1502384	12018654	222.640	85,00	105,00		12,00	18,00	SPSC SOL -Left	FKM+ACM

ŞANZİMAN GRUBU / Gearbox Group

SKT NO	KULLANILAN MODELLER Models	KULLANIM YERİ Place Of Use	ORJİNAL NO 1 Original No 1	ORJİNAL NO 2 Original No 2	EŞDEĞER NO 1 Equivalent No 1	EŞDEĞER NO 2 Equivalent No 2	ÖLÇÜLER - MM. Dimensions - MM.					TİP Type	MALZEME Material
045756-P	93-111-112-113-143- SERİSİ 860-870 ŞANZ.	ŞANZİMAN ÖN Gearbox Front	3140639	274868	12011970	352.562	45,00	65,00		9,00		L1L SAĞ -Right	ACM
045779-V	93-113-143 SERİSİ	ŞANZİMAN ÖN Gearbox Front	388528	3885282	12015765	01017588	45,00	65,00		10,00		L3L	FKM
045779-V	KAMYON SERİSİ	ŞANZİMAN ÖN Gearbox Front	42521712	-	12015765	01017588	45,00	65,00		10,00		L3L	FKM
045851-V	93-113-143-94-114-124-144 SERİSİ-GRS-900 ŞANZ.	ŞANZİMAN ÖN Gearbox Front	378620	1318388	12015253	284.645	55,00	75,00		8,00		L1 SAĞ-Right	FKM
047544-V	124 SERİSİ	ŞANZİMAN ÖN Gearbox Front	1324874	1489047	01032873	-	75,00	100,00		10,00		L3L	FKM
047752	111-112-93-113 SERİSİ	ŞANZİMAN ÖN Gearbox Front	3150224	315022	12014609	-	68,00	80,00		8,00		SPL5	NBR
047753-P	111-113-142-143 SERİSİ	ŞANZİMAN ARKA Gearbox Rear	3727914	1305712	12015254	042.463	80,00	100,00		13,00	15,00	SLLL SS-RL	ACM
4TM-166	GR/GRS/GRSO 875R-905R-895R-925R ŞANZ.(046162-FP+046168-FP)	RETARDER KEÇE TM.TK. Retarder Sys.Seal Rep. Kit	1900052	-	-	-	-	-		-		-	-
040844	P-G-R-T-3-4 SERİSİ	VİTES SEÇİCİ MİLİ Gear Selection Shaft	329638	3296381	12014616	038.083	25,00	35,00		6,00	-	L3BTL	NBR
040774-V	TÜM MODELLER ZF 9S75 ŞANZ.	ŞANZİMAN KLM.ÇIKIŞ MİLİ Speedometer Shaft	-	-	01002259	010.804	10,00	15,00		3,00		SPL5	FKM

ŞANZİMAN GRUBU / Gearbox Group

SKT NO	KULLANILAN MODELLER Models	KULLANIM YERİ Place Of Use	ORJİNAL NO 1 Original No 1	ORJİNAL NO 1 Original No 2	EŞDEĞER NO 1 Equivalent No 1	EŞDEĞER NO 1 Equivalent No 2	ÖLÇÜLER - MM. Dimensions - MM.				TİP Type	MALZEME Material	
045768-P	93-113-143-94-124-144	PTO MİLİ Power Take Off Shaft	2140051	214005	12010967	-	50,00	68,00		8,00		L3TL	ACM
045820-V	93-113-143-114-124-144	PTO MİLİ Power Take Off Shaft	11045002	1357857	01019463	-	50,00	70,00		9,00		L3TL SS-RL	FKM
410318-V	93-113-114-124- SERİSİ	PTO MİLİ Power Take Off Shaft	386968	-	12014743	007.745	72,00	105,00		13,00		L1L	FKM
040182	KAMYON SERİSİ	ŞANZ. DEBRİYAJ KEÇESİ Clutch Shaft Seal	172392	-	12010784	164.500	14,00	24,00		7,00		L3	NBR
041177	TÜM MODELLER ZF 9S75	ŞANZ. DEBRİYAJ KEÇESİ Clutch Shaft Seal	3296381	329638	12014616	038.083	25,00	35,00		7,00		L13TL	NBR
040465	KAMYON SERİSİ ZF85-151-165-151	ŞANZ. DEBRİYAJ KEÇESİ Clutch Shaft Seal	254635	-	12011487	038.083	25,00	35,00		7,00		L1L	NBR
041111-V	TÜM MODELLER ZF 9S75 ŞANZ.	ŞANZİMAN KULESİ Gearbox Tower	0501316333	-	01032393	-	22,00	36,00	57,00	14,50		SPL3CTL	FKM
045660	3-93-113-143 SERİSİ	KARDAN MİLİ SİSTEMİ Propeller Shaft	120828	1208289	12010950	040.606	45,00	60,00		7,00		L3L	NBR
047754	93-113-94-114-124-144 SERİSİ	KARDAN MİLİ SİSTEMİ Propeller Shaft	294275	-	12001716	-	75,00	90,00		10,00	11,00	L3TL	NBR

DİREKSİYON GRUBU / Steering Group

SKT NO	KULLANILAN MODELLER Models	KULLANIM YERİ Place Of Use	ORJİNAL NO 1 Original No 1	ORJİNAL NO 1 Original No 2	EŞDEĞER NO 1 Equivalent No 1	EŞDEĞER NO 1 Equivalent No 2	ÖLÇÜLER - MM. Dimensions - MM.				TİP Type	MALZEME Material	
040743	111-112-142	DİREKSİYON KUTUSU Steering Box	318996	-	12014826	006.408	26,00	37,00		7,00	8,00	L3BTL	NBR
040541	111-112-141-142	DİREKSİYON POMPASI Power Steering Pump	-	-	12011381	-	17,00	28,00		8,00		L1X	NBR

MOTOR GRUBU / Engine Group

SKT NO	KULLANILAN MODELLER Models	KULLANIM YERİ Place Of Use	ORJİNAL NO 1 Original No 1	ORJİNAL NO 1 Original No 2	EŞDEĞER NO 1 Equivalent No 1	EŞDEĞER NO 1 Equivalent No 2	ÖLÇÜLER - MM. Dimensions - MM.				TİP Type	MALZEME Material	
040923-V	OTOBÜS SERİSİ	HAVA KOMPRESÖRÜ Air Compressor	-	-	-	-	20,00	31,65		7,00		L3TL	FKM

AKS GRUBU / Axle Group

SKT NO	KULLANILAN MODELLER Models	KULLANIM YERİ Place Of Use	ORJİNAL NO 1 Original No 1	ORJİNAL NO 1 Original No 2	EŞDEĞER NO 1 Equivalent No 1	EŞDEĞER NO 1 Equivalent No 2	ÖLÇÜLER - MM. Dimensions - MM.				TİP Type	MALZEME Material	
047729	SAFİR - PRESTIJ OTOBÜS	ÖN AKS Front Axle	MB025295	-	VKS6451	-	72,00	94,00		10,00		L1L	NBR
412303	SAFİR - PRESTIJ OTOBÜS	ARKA AKS Rear Axle	MB308965	-	19035300	-	85,00	127,00		13,00		SPSLL	NBR
410379	SAFİR - PRESTIJ OTOBÜS	ARKA AKS PORYA DIŞ Rear Axle Outer	MB308966	-	VKS6475	-	56,00	114,00		10,00		SPL3	NBR

ŞANZIMAN GRUBU / Gearbox Group

SKT NO	KULLANILAN MODELLER Models	KULLANIM YERİ Place Of Use	ORJİNAL NO 1 Original No 1	ORJİNAL NO 1 Original No 2	EŞDEĞER NO 1 Equivalent No 1	EŞDEĞER NO 1 Equivalent No 2	ÖLÇÜLER - MM. Dimensions - MM.				TİP Type	MALZEME Material	
045681-P	SAFİR - PRESTIJ OTOBÜS	ŞANZIMAN ÖN Gearbox Front	ME642211	-	01033472	01030363	40,00	58,00		8,00		L3L SAĞ -Right	ACM
045967-P	SAFİR - PRESTIJ OTOBÜS	ŞANZIMAN ARKA Gearbox Rear	MH034181	-	-	-	50,00	65,00		9,00		L3L SOL-Left	ACM

MOTOR GRUBU / Engine Group

SKT NO	KULLANILAN MODELLER Models	KULLANIM YERİ Place Of Use	ORJİNAL NO 1 Original No 1	ORJİNAL NO 2 Original No 2	EŞDEĞER NO 1 Equivalent No 1	EŞDEĞER NO 2 Equivalent No 2	ÖLÇÜLER - MM. Dimensions - MM.					TİP Type	MALZEME Material
410491-VK	B7-FE-FL DEUTZ 1013 MOT.	KRANK ÖN Crank Shaft Front	20412568	04253373	01027762	084.920	81,00	104,00		11,00		L13TL SAĞ -Right	FKM +YÜN-NW
410392-V	F12-FL10-N10-N12-NL10-NL12	KRANK ÖN Crank Shaft Front	4695078	424983	12013988	570.495	85,73	114,33		13,00		L13TL SAĞ -Right	FKM
415240-FPK	A9-B9-B11-FH-FM9-D13 MOT.	KRANK ÖN Crank Shaft Front	1549398	85108423	20036083	000.270	136,00	159,00		13,00		F2TK SAĞ -Right	PTFE+ACM +YÜN-NW
412384-VAEK	B7-FE-FL DEUTZ 1013 MOT.	KRANK ARKA Crank Shaft Rear	04253333	20412286	01027763	NA5475	130,00	150,00		13,00		L3TL SOL -Left	FKM+AEM +YÜN-NW
417134-FPK	A-B9-B11-FM9-FMX-RVI-D13 MOT.	KRANK ARKA Crank Shaft Rear	8148259	-	19037091	-	150,00	180,00		15,00		F25TK SOL -Left	PTFE+ACM +YÜN-NW
417083-V	TÜM MODELLER	KRANK ARKA Crank Shaft Rear	4693362	424171	12015806	15071900	155,00	180,00		15,00		L1L SOL-Left	FKM
420062-V	F16-FH12-FH16-FH400-440-460-480-500	KRANK ARKA Crank Shaft Rear	15438963	1543896	12015255	081.460	180,00	205,00		15,00		L13TL SOL -Left	FKM
45-030-V	F16-FL6-FH12-FL7-FM	SUPAP Valve Stem Seal	20459855	859171	12015512	104.380	8,00	12,00	15,20	9,50		LSY2T	FKM
040745-V	F10-F12-FL10	YAKIT POMPASI Fuel Pump	2400224	1926005	12011122	038.075	25,00	35,00		7,00		L3TL	FKM
041177	F10-F12-FL10-N10-N12-NL12	YAKIT POMPASI Fuel Pump	2400224	244073	12011122	038.075	25,00	35,00		7,00		L13TL	NBR
040173	F12-FH12-FL10-FH16	SU POMPASI Water Pump	9588112	958811	12010796	-	15,00	35,00		7,00		L3	NBR
040272	FH12	SU POMPASI Water Pump	-	-	054.003	-	17,00	35,00		7,00		L3	NBR
040084	400	SU POMPASI Water Pump	-	-	12010828	12012842	20,00	42,00		7,00		L3	NBR

AKS GRUBU / Axle Group

SKT NO	KULLANILAN MODELLER Models	KULLANIM YERİ Place Of Use	ORJİNAL NO 1 Original No 1	ORJİNAL NO 2 Original No 2	EŞDEĞER NO 1 Equivalent No 1	EŞDEĞER NO 2 Equivalent No 2	ÖLÇÜLER - MM. Dimensions - MM.					TİP Type	MALZEME Material
046038	F12-N12-NL10-NL12	ÖN AKS Front Axle	9460924	946092	01002852	-	45,00	65,00		10,00		L1L	NBR
410478-V	-	ÖN AKS RULMANI Front Axle Bearing	-	-	-	-	85,30	110,10	115,00	6,45	8,00	SPSC8	FKM
410479-V	ÇEKİCİ SERİSİ	ÖN AKS RULMANI Front Axle Bearing	20518611	-	-	-	85,35	110,00	-	7,00	-	SPL25	FKM
410477-V	ÇEKİCİ SERİSİ	ÖN AKS RULMANI Front Axle Bearing	201518632	-	-	-	98,00	125,00	-	6,45	-	SPL25	FKM
410483-V	-	ÖN AKS RULMANI Front Axle Bearing	-	-	-	-	98,00	125,25	133,70	7,35	9,65	SPSC8	FKM
412393-V	YENİ MOD. (FAG RULMAN İÇİN)	ÖN-ARKA AKS RULMANI Front-Rear Axle Bearing	356014382 SET	-	0293 V30	-	125,00	142,00		8,00	9,20	SC	FKM
410263	KAMYON	ÖN AKS Front Axle	11668067	-	12014731	12015406	100,00	125,00		13,00		L3L	NBR
412316-V	F10-F12-F16-FH16-FL12-FM7-N10	ÖN AKS Front Axle	1089552	10895522	12014742	522.911	110,00	140,00		12,00	19,00	SPL13TLLR SS-RL	FKM
412159	F10-F12-N10-N12-NL10-NL12-FM9	ÖN AKS Front Axle	9460932	20772463	12011367	-	125,00	150,00		13,00		L1L	NBR
046247-V	FL12-FM7-FM9-FM10	ARKA AKS Rear Axle	1522373	-	20019176	-	50,00	65,00		8,00		L1 SS-RL	FKM
412196	KAMYON SERİSİ-EM	ARKA AKS Rear Axle	968013	9680133	12019646	12017368	110,00	130,00		13,00		L1L	NBR
415248	KAMYON SERİSİ - EM	ARKA AKS Rear Axle	14023787	-	01003482	-	118,00	160,00		13,00		SLL	NBR
412170	F12	ARKA AKS Rear Axle	16960668	1696066	12012064	042.935	120,00	140,00		13,00		L1L	NBR
415033	F88-FB88	ARKA AKS Rear Axle	-	-	-	-	126,87	169,89		12,70		CSL	NBR
415239-V	ZF AKSLI MODELLER	ARKA AKS Rear Axle	85109330	-	12019945	-	130,00	170,00		18,00	20,00	SC12	FKM
415127	F88-F7-F10-N10N12-F12-F88	ARKA AKS Rear Axle	944667	1577624	12011387	522.856	133,35	155,60		14,00		L1 SS-RL	NBR
415190-V	F10-12-F16-FH16-FL12-FM10-FM7-FM9-N10	ARKA AKS Rear Axle	1672249	-	12016932	-	140,00	164,00		15,50	18,00	SPL3TLL SS-RL	FKM
417070	F88-F12-N12	ARKA AKS Rear Axle	1522896	-	12011324	590.738	150,00	180,00		16,00	18,00	L1LL	NBR

AKS GRUBU / Axle Group

SKT NO	KULLANILAN MODELLER Models	KULLANIM YERİ Place Of Use	ORJİNAL NO 1 Original No 1	ORJİNAL NO 1 Original No 2	EŞDEĞER NO 1 Equivalent No 1	EŞDEĞER NO 1 Equivalent No 2	ÖLÇÜLER - MM. Dimensions - MM.					TİP Type	MALZEME Material
417054	N12-F10-F12-F16-FH12-FH16-FL10	ARKA AKS Rear Axle	944666	1591903	12014351	522.880	168,02	187,83	189,83	18,00	32,45	SPL1L SS-RL	NBR
412354-V	FH12-FM9-FM10-FM12-FM16-FL6	ARKA AKS RULMANI Rear Axle Bearing Seal	20518462	-	-	-	125,00	148,30	152,30	8,10	9,30	SC	FKM
412353-V	FH12-FM9-FM10-FM12-FM16-FL6	ARKA AKS RULMANI Rear Axle Bearing Seal	-	-	-	-	125,00	148,00		7,00	9,70	SPLL13 SS-RL	FKM
4TM-089	FH12-FM9-FM10-FM12-FM16-FL6-ZF AKSLI MOD.	ARKA AKS TAMİR TAKIMI Rear Axle Repair Kit	3095043	3095042	19037007	735.540						TM	
4TM-162	ZF AKSLI MODELLER (412353-V+412354-V)	ARKA AKS TAMİR TAKIMI Rear Axle Repair Kit	3095043	3095042	19037007	-						TM	
4TM-109	VOLVO KAMYON SERİSİ ZF DİNGİL SERİSİ	ARKA AKS TAMİR TAKIMI Rear Axle Repair Kit	-	-	-	-							4TM- 089+4H-974
4TM-160	Çekici Serisi (410483-V+410477-V)	ARKA AKS TAMİR TAKIMI Rear Axle Repair Kit	20518632	-	-	-						TM	
4TM-161	Çekici Serisi (410478-V+410479-V)	ARKA AKS TAMİR TAKIMI Rear Axle Repair Kit	20518611	20367196	797670	-						TM	
4D-345-S	KAMYON ÇEKİCİ	FREN Z-KAM MİLİ Brake Z Shaft	68492410	-	-	-	35,75	68,30		19,85		LS	VMQ
040900-Z	KAMYON ÇEKİCİ	FREN Z-KAM MİLİ Brake Z Shaft	68200114	-	-	-	37,40	47,70		4,70		L1L	NBR

DİFERANSİYEL GRUBU / Differential Group

SKT NO	KULLANILAN MODELLER Models	KULLANIM YERİ Place Of Use	ORJİNAL NO 1 Original No 1	ORJİNAL NO 1 Original No 2	EŞDEĞER NO 1 Equivalent No 1	EŞDEĞER NO 1 Equivalent No 2	ÖLÇÜLER - MM. Dimensions - MM.					TİP Type	MALZEME Material
047383-V	F10-F12-N10-N12-NL10-NL12	ÖN DİFR. MAHRUTİ Front Differential	2670750	267075	12015935	041.866	65,00	90,00		13,00		L3L SS-RL	FKM
410498-V	FH12-FH16-FM7-FM9-FM12 MERİTOR DİFR.	MAHRUTİ (DİFER.ÖN) Differential - Front	1524838	-	49364255	-	68,00	102,00		9,50	14,50	SPL3TLR SOL-Left	FKM
410394-V	F10-F12-F16-FH12-FH16-FL10	MAHRUTİ (DİFER.ÖN) Differential - Front	9484486	948448	12013871	-	80,00	110,05		12,00		L1L SOL-Left	FKM
412250-V	TÜM MODELLER	MAHRUTİ (DİFER.ÖN) Differential - Front	1522895	15228950	12014745	588.016	80,00	130,00		12,00	20,00	SPLLL SAĞ -Right	FKM
412249-V	F10-F7-F12-FL10-FL7-N10	MAHRUTİ (DİFER.ÖN) Differential - Front	15228943	152894	12014744	588.008	80,00	150,00		12,00	20,00	SPL1L SAĞ -Right	FKM

DİFERANSİYEL GRUBU / Differential Group

SKT NO	KULLANILAN MODELLER Models	KULLANIM YERİ Place Of Use	ORJİNAL NO 1 Original No 1	ORJİNAL NO 2 Original No 2	EŞDEĞER NO 1 Equivalent No 1	EŞDEĞER NO 2 Equivalent No 2	ÖLÇÜLER - MM. Dimensions - MM.				TİP Type	MALZEME Material	
410489-V	-	MAHRUTİ (DİFER.ÖN) Differential - Front	3098229	-	01029710	-	90,00	125,00		12,00	19,00	L3TLR SAĞ -Right	FKM
410391-V	TÜM MODELLER	MAHRUTİ (DİFER.ÖN) Differential - Front	9486424	948642	12014746	587.991	90,00	125,25		10,00		L1L SAĞ -Right	FKM
412314-V	F16-FH12-FH16-FM12-FM10	MAHRUTİ (DİFER.ÖN) Differential - Front	15232390	1523239	12015693	01034125	90,00	145,00		10,00	15,00	L13TLR SAĞ -Right	FKM
415191-V	FH12-FH16	MAHRUTİ (DİFER.ÖN) Differential - Front	15236342	3192615	01016886	435.990	90,00	151,00		10,00	15,00	L13TLR SAĞ -Right	FKM
412388-V	FH-FL-FM-B9-B11-B12-FE-FH400- FH420-440-460	MAHRUTİ (DİFER.ÖN) Differential - Front	20832385	22468905	01031695	-	110,23	145,00		10,00	12,00	SPSC10	FKM
415249-V	VOLVO FH12-FH16-FM9-FM12	MAHRUTİ (DİFER.ÖN) Differential - Front	21448461	-	12036895	-	90,00	151,00		11,00	18,00	SPSC10	FKM

ŞANZİMAN GRUBU / Gearbox Group

SKT NO	KULLANILAN MODELLER Models	KULLANIM YERİ Place Of Use	ORJİNAL NO 1 Original No 1	ORJİNAL NO 2 Original No 2	EŞDEĞER NO 1 Equivalent No 1	EŞDEĞER NO 2 Equivalent No 2	ÖLÇÜLER - MM. Dimensions - MM.				TİP Type	MALZEME Material	
046021-VK	FLC SERİSİ ZFS5-42	ŞANZİMAN ÖN Gearbox Front	85103222	-	01029649	12019650	40,00	52,00		8,50		L3TL SAĞ -Right	FKM +YÜN-NW
046132-P	F16	ŞANZİMAN ÖN Gearbox Front	6770963	1218034	12013896	040.363	42,00	62,00		10,00		L3TL SAĞ -Right	ACM
045827-V	FL6	ŞANZİMAN ÖN Gearbox Front	X8870760	-	20016209	586.676	48,00	65,00		10,00		L13TL SAĞ -Right	FKM
046115-P	NL10-NL12 ZF 16S151	ŞANZİMAN ÖN Gearbox Front	1526688	-	01031969	515.340	55,00	75,00		8,00	9,20	L1R SAĞ -Right	ACM
047751-V	TÜM MODELLER	ŞANZİMAN ÖN Gearbox Front	267268	9430448	12013360	587.958	64,90	90,00		10,00		L3TL SAĞ -Right	FKM
045330	S6-85-F16	ŞANZİMAN ÖN Gearbox Front	6876127	68572791	12011331	040.991	48,00	65,00		10,00		L1	NBR
045880-V	S6-85-F16 F6-FL6	ŞANZİMAN ÖN İÇ Gearbox Front	6876126	68761261	12011306	284.662	48,00	69,00		10,00		L1 SAĞ-Right	FKM
046011	TÜM MODELLER ZF 9S75	ŞANZİMAN ÖN Gearbox Front	1288043	-	01017792	-	60,00	74,80		4,70		SPL5	NBR

ŞANZIMAN GRUBU / Gearbox Group

SKT NO	KULLANILAN MODELLER Models	KULLANIM YERİ Place Of Use	ORJİNAL NO 1 Original No 1	ORJİNAL NO 2 Original No 2	EŞDEĞER NO 1 Equivalent No 1	EŞDEĞER NO 2 Equivalent No 2	ÖLÇÜLER - MM. Dimensions - MM.					TİP Type	MALZEME Material
047839-VAE	KAMYON-ÇEKİCİ SERİSİ ZF S5-425	ŞANZIMAN ARKA Gearbox Rear	6876131	3104402	20027594	12014236	70,00	90,00	-	10,00	-	L3TL SOL -Left	FKM+AEM
047193	KAMYON	ŞANZIMAN ARKA Gearbox Rear	114079	5115454	-	-	73,02	95,40	-	12,70	-	SL	NBR
047193-S	KAMYON	ŞANZIMAN ARKA Gearbox Rear	114079	-	-	-	73,02	95,40	-	12,70	-	SL	VMQ
047650-V	F10-F12-F16-FL10-N10-N12-F88 ZF 9S75	ŞANZIMAN ARKA Gearbox Rear	2672699	9437047	12013361	587.966	80,00	100,00		8,00		L3TL SOL -Left	FKM
047711-V	F10-F12-F16-FL10-N10-N12-F88 ZF 9S75	ŞANZIMAN ARKA Gearbox Rear	2672699	9437047	01020467	587.966	80,00	100,00		10,00		L13TL SS-RL	FKM
410435-V	KAMYON-ÇEKİCİ	ŞANZIMAN ARKA Gearbox Rear	1662026	-	20034608	-	90,00	125,00		12,00		L3TL SAĞ -Right	FKM
410403-V	F16 ZF 9S109-16S109	ŞANZIMAN ARKA Gearbox Rear	20852864	-	01026691	-	105,00	125,00		12,00	9,50	L13TL SOL -Left	FKM
412344-V	NL10-NL12	ŞANZIMAN ARKA Gearbox Rear	1662607	-	01016923	490.840	105,00	130,00		12,00		L13TL SOL -Left	FKM
412100	KAMYON SERİSİ	ŞANZIMAN ARKA Gearbox Rear	1526828	15268287	12011062	282.200	105,00	130,00	-	13,00	-	L3	NBR
047049	S6-85-F16-F6-FL6	ŞANZIMAN ARKA-DIŞ Gearbox Rear - Outer	6876132	-	12011015	-	70,00	90,00		10,00		L3	NBR
410393	F16-FH12-FH16-NL10-NL12	ŞANZIMAN ARKA-DIŞ Gearbox Rear - Outer	16526220	1622622	12016749	-	90,00	111,00		6,00	8,00	CL2	NBR
410123	NL10-NL12	ŞANZIMAN ARKA-DIŞ Gearbox Rear - Outer	1526828	15268287	12011062	282.200	105,00	130,00		12,00		L3	NBR
412100	NL10-NL12	ŞANZIMAN ARKA-DIŞ Gearbox Rear - Outer	1526828	15268287	12011062	282.200	105,00	130,00	-	13,00	-	L3	NBR
047343-V	S6-85-F16	ŞANZIMAN ARKA-DIŞ Gearbox Rear - Outer	6876131	3104402	12014736	348.856	70,00	90,00		10,00		L1 SOL-Left	FKM
047343-V	ZF S6-85-16S130	ŞANZIMAN ARKA-DIŞ Gearbox Rear - Outer	0634300646	-	12014736	348.856	70,00	90,00		10,00		L1 SOL-Left	FKM
412315-V	F16-FH162-FH16-NL10-NL2	ŞANZIMAN ARKA-DIŞ Gearbox Rear - Outer	1652776	-	12016675	-	90,00	145,00		10,00		L13TL SOL -Left	FKM
412290-V	-	ŞANZIMAN ARKA-DIŞ Gearbox Rear - Outer	0219976447	-	01016923	490.840	105,00	130,00		11,00		L13L SOL -Left	FKM
040774-V	F10-N10-N10-N12 ZF 9S75 ŞANZ.	ŞANZIMAN KLM.ÇIKIŞ MILİ Speedometer Shaft	24472657	3468220	01002259	010.804	10,00	15,00		3,00		SPL5	FKM

ŞANZIMAN GRUBU / Gearbox Group

SKT NO	KULLANILAN MODELLER Models	KULLANIM YERİ Place Of Use	ORJİNAL NO 1 Original No 1	ORJİNAL NO 2 Original No 2	EŞDEĞER NO 1 Equivalent No 1	EŞDEĞER NO 2 Equivalent No 2	ÖLÇÜLER - MM. Dimensions - MM.					TİP Type	MALZEME Material
040844	KAMYON-CEKİCİ	VİTES SEÇİCİ MİLİ Gear Selection Shaft	6876348	68763481	12014616	038.083	25,00	35,00	-	6,00	-	L3BTL	NBR
045756-P	F16	PTO MİLİ Power Take Off Shaft	15439367	15439367	12017221	-	45,00	65,00		8,00		L1L SAĞ -Right	ACM
047684-V	F16-NL10-NL12 16S1300	PTO MİLİ Power Take Off Shaft	6771323	-	01026471	-	55,00	80,00		8,00		L3L	FKM
047591-P	F16-FL6	PTO MİLİ Power Take Off Shaft	958726	9587262	12011282	446.602	55,00	80,00		10,00		L1L	ACM
045575	ESKİ MODELLER	PTO MİLİ Power Take Off Shaft	946092	9460924	01002852	-	45,00	65,00		10,00		L1	NBR
041152	F10-F16-N10-F7-FL6-N10	ŞANZ. DEBRİYAJ KEÇESİ Clutch Shaft Seal	943379	-	01031085	-	16,00	28,00		8,00		L3L	NBR
040591	F16	ŞANZ. DEBRİYAJ KEÇESİ Clutch Shaft Seal	1560779	-	01002918	-	22,00	32,00		7,00		L3L	NBR
041177	NL10-NL12 ZF 9S75	ŞANZ. DEBRİYAJ KEÇESİ Clutch Shaft Seal	6876348	68763481	12014616	038.083	25,00	35,00		7,00		L13TL	NBR
041174	8S-151	ŞANZ. DEBRİYAJ KEÇESİ Clutch Shaft Seal	244073	2440733	12010846	125.208	25,00	35,00		7,00		L3	NBR
041110-V	KAMYON-ÇEKİCİ ZF 9S109-16S109	ŞANZIMAN KULESİ Gearbox Tower	3123295	-	01029805	-	22,00	36,00	48,00	14,50		SPL3CTL	FKM
041111-V	NL10-NL12 ZF 9S75 ŞANZ.	ŞANZIMAN KULESİ Gearbox Tower	0501316333	-	01032393	-	22,00	36,00	57,00	14,50		SPL3CTL	FKM
4P-262-V	9S109-16S109-130-150-151-181-221 ŞANZ.	ŞANZIMAN PİSTON KEÇESİ Gearbox U Packing Seal	1527355	-	504.540	5045400	53,00	63,00		16,20		PCX4	FKM
4P-260-H	ZF 9S75 ŞANZ.	TAKVİYE PİSTON KEÇESİ Reinforcement Piston Seal	3099420	0734309379	12014453	-	63,00	16,00		10,50		LS	HNBR

DİREKSİYON GRUBU / Steering Group

SKT NO	KULLANILAN MODELLER Models	KULLANIM YERİ Place Of Use	ORJİNAL NO 1 Original No 1	ORJİNAL NO 2 Original No 2	EŞDEĞER NO 1 Equivalent No 1	EŞDEĞER NO 2 Equivalent No 2	ÖLÇÜLER - MM. Dimensions - MM.				TİP Type	MALZEME Material	
040929	FL-FM9 SERİSİ	DİREKSİYON KUTUSU Steering Box	0770080252	0770198134	01020066	-	26,00	34,00		4,50	7,00	SPL3BL	NBR
040743	-	DİREKSİYON KUTUSU Steering Box	341050	-	12014826	006.408	26,00	37,00		7,00	8,00	L3BTL	NBR
040442	N88	DİREK. SEKTOR MİLİ Steering Sector Shaft	-	-	-	-	30,00	47,00		10,00		L3X	NBR
045930	L485	DİREK. SEKTOR MİLİ Steering Sector Shaft	67371	-	-	-	45,00	62,00		7,00		L3BTL	NBR

MOTOR / Engine

SKT NO	KULLANILAN MODELLER Models	KULLANIM YERİ Place Of Use	ORJİNAL NO 1 Original No 1	ORJİNAL NO 1 Original No 2	EŞDEĞER NO 1 Equivalent No 1	EŞDEĞER NO 1 Equivalent No 2	ÖLÇÜLER - MM. Dimensions - MM.					TİP Type	MALZEME Material
047686-V	4BT-6BT-6BTC MOTOR SERİSİ	KRANK ÖN Crank Shaft Front	3900709	3935959	19036787	15068800	63,50	79,58	79,75	7,93		L13TL SAĞ -Right	FKM
047834-FH	4BT-6BT-6BTC MOTOR SERİSİ	KRANK ÖN Crank Shaft Front	9P909649	-	-	-	63,50	79,58		7,93		F5F SAĞ -Right	PTFE +HNBR
047687-V	6CT-6CTA MOTOR SERİSİ	KRANK ÖN Crank Shaft Front	3921927	4025270	49359771	15073500	75,01	93,07	93,42	11,51		L13TL SAĞ -Right	FKM
047833-FS	6CT-6CTA MOTOR SERİSİ	KRANK ÖN Crank Shaft Front	9P912300	-	-	-	75,01	93,07		11,51		F5F SAĞ -Right	PTFE+VMQ
412291-V	4BT-4CT-6BT-6CT-6CTA TÜM MODELLER	KRANK ARKA Crank Shaft Rear	3925529	3933262	19036879	15068900	130,18	150,25	150,47	14,28		L13TL SOL -Left	FKM
4S-043-V	CUMMINS 6BT MOT.	SUPAP Valve Stem Seal	9P917760	-	-	-	7,35	13,50	33,90	18,20	23,80	LSY5T	FKM
4S-044-V	CUMMINS 6CT MOT.	SUPAP Valve Stem Seal	9P900103	-	-	-	9,00	15,70	22,10	9,10	14,09	LSY5T	FKM
4CN-063-V	6BT-6CT MOT. SERİSİ	SİLİNDİR GÖMLEK LASTİĞİ Cylinder Liner	3907177	-	-	-	118,00	122,32		4,00		MH	FKM

MOTOR / Engine

SKT NO	KULLANILAN MODELLER Models	KULLANIM YERİ Place Of Use	ORJİNAL NO 1 Original No 1	ORJİNAL NO 1 Original No 2	EŞDEĞER NO 1 Equivalent No 1	EŞDEĞER NO 1 Equivalent No 2	ÖLÇÜLER - MM. Dimensions - MM.					TİP Type	MALZEME Material
047868-V	FL912-913 MOT.	KRANK ÖN Crank Shaft Front	02234133	04150782	12012095	-	65,00	85,00		13,00		SPL1L SAĞ -Right	FKM
410491-VK	1013 MOT.	KRANK ÖN Crank Shaft Front	04253373	20412568	01027762	084.920	81,00	104,00		11,00		L13TL SAĞ -Right	FKM +YÜN-NW
410473-V	F8L-BF714	KRANK ÖN Crank Shaft Front	0116 3316	04146007	01016938	-	95,00	120,00	-	12,00	-	L3TL	FKM
4S-041-V	FL912-913-1013 MOT.	SUPAP Valve Stem Seal	04153728	04179944	12015512	49472020	8,00	12,00	15,50	9,50		LSY4T	FKM
412364-V	FL912-913 MOT.	KRANK ARKA Crank Shaft Rear	042300392	04232267	20020867	-	115,00	140,00		13,50		SPL3TL SOL -Left	FKM
412384-VAEK	1013 MOT.	KRANK ARKA Crank Shaft Rear	04253333	20412286	01027763	NA5475	130,00	150,00		13,00		L3TL SOL -Left	FKM+AEM +YÜN-NW

PERKINS

MOTOR / Engine

SKT NO	KULLANILAN MODELLER Models	KULLANIM YERİ Place Of Use	ORJİNAL NO 1 Original No 1	ORJİNAL NO 1 Original No 2	EŞDEĞER NO 1 Equivalent No 1	EŞDEĞER NO 1 Equivalent No 2	ÖLÇÜLER - MM. Dimensions - MM.					TİP Type	MALZEME Material
047894-V	6.354 MOT.	KRANK ÖN Crank Shaft Front	2418F437	-	12014981	587.010	60,33	79,62		9,33	11,23	L3TL SAĞ -Right	FKM
047558-V	6.354 MOT.	KRANK ÖN Crank Shaft Front	2418F436	2415361	12014981	587.010	60,33	79,62		9,52	11,11	L3L SAĞ -Right	FKM
415171-V	6.354 MOT.	KRANK ARKA Crank Shaft Rear	2418F475	1800T	12010753	587.842	133,35	158,94	159,16	11,11	11,13	L13TL SOL -Left	FKM
415137-V	6.354 MOT.	KRANK ARKA Crank Shaft Rear	2418F475	1800T	12010753	587.842	133,35	159,05		11,11	13,00	L3L SOL-Left	FKM
45-009-V	6.354 MOT.	SUPAP Valve Stem Seal	1272T	33817117	12016623	-	9,45	14,25	16,61	10,69	14,27	L	FKM

BPW

AKS / Axle

SKT NO	KULLANILAN MODELLER Models	KULLANIM YERİ Place Of Use	ORJİNAL NO 1 Original No 1	ORJİNAL NO 1 Original No 2	EŞDEĞER NO 1 Equivalent No 1	EŞDEĞER NO 1 Equivalent No 2	ÖLÇÜLER - MM. Dimensions - MM.					TİP Type	MALZEME Material
412309	ECOPLUS - TEK TEKERLİ AKS	DORSE AKS Trailer Axle	02 5664 5700	01016766	-	-	115,00	136,70		8,00	10,50	CSPL3LL	NBR
415234	ECOPLUS DORSE YM. 3 PİMLİ-SACLI	DORSE AKS Trailer Axle	256647400	-	VKS6376	-	117,50	158,00		17,80		SPLCL2	NBR
412390	YENİ MODEL DORSELER	DORSE AKS Trailer Axle	0256642657	-	12015710	-	125,00	143,00		13,00		L3TL SS-RL	NBR
415186	JUMBO TEKER	DORSE AKS Trailer Axle	02 5664 5800	01026187	-	-	135,00	156,70		8,00	10,50	CSPL3LL	NBR

AKS / Axle

SKT NO	KULLANILAN MODELLER Models	KULLANIM YERİ Place Of Use	ORJİNAL NO 1 Original No 1	ORJİNAL NO 1 Original No 2	EŞDEĞER NO 1 Equivalent No 1	EŞDEĞER NO 1 Equivalent No 2	ÖLÇÜLER - MM. Dimensions - MM.					TİP Type	MALZEME Material
412170	DORSE	DORSE AKS Trailer Axle	4373000300	-	12012064	042.935	120,00	140,00		13,00		L1L	NBR
415078	DORSE	DORSE AKS Trailer Axle	4373001000	-	12011349	255.637	140,00	160,00		13,00		L1	NBR
412383-V	DORSE	DORSE AKS Trailer Axle	04373004700	5373004700	-	-	112,00	138,50		6,80		SPL25L	FKM
412382-V	DORSE	DORSE AKS Trailer Axle	04373004600	5373004600	-	-	112,00	138,50		8,50		SPSC9	FKM
417110	DORSE EM	DORSE AKS Trailer Axle	4 266 0028 01	-	-	-	142,00	184,00		7,50		SPL1R	NBR
4TM-167	DORSE AKS (412382-V+412383)	DORSE AKS Trailer Axle Reapair Kit	4200101900	-	-	-						TM	-
415187	DORSE YM	DORSE AKS Trailer Axle	4 373 0044 00	-	-	-	142,15	175,5		11,40		SPL2R	NBR
415188-V	DORSE YM	DORSE AKS Trailer Axle	4 373 0043 00	-	-	-	142,15	175,5		11,40		SPL3R	FKM

FRUEHAUF

AKS / Axle

SKT NO	KULLANILAN MODELLER Models	KULLANIM YERİ Place Of Use	ORJİNAL NO 1 Original No 1	ORJİNAL NO 1 Original No 2	EŞDEĞER NO 1 Equivalent No 1	EŞDEĞER NO 1 Equivalent No 2	ÖLÇÜLER - MM. Dimensions - MM.					TİP Type	MALZEME Material
415246	DORSE KEÇESİ	DORSE AKS Trailer Axle	AJA05640	-	-	-	107,95	152,63		24,66		SPSC	NBR
417106	DORSE KEÇESİ	DORSE AKS Trailer Axle With Abs	M003125	12016931	-	-	108,00	152,60	185,00	15,00	19,00	SCABS1	NBR

DORSE VE İLAVE AKSLAR - (Trailer Axles)

AKS / Axle

SKT NO	KULLANILAN MODELLER Models	KULLANIM YERİ Place Of Use	ORJİNAL NO 1 Original No 1	ORJİNAL NO 2 Original No 2	EŞDEĞER NO 1 Equivalent No 1	EŞDEĞER NO 2 Equivalent No 2	ÖLÇÜLER - MM. Dimensions - MM.					TİP Type	MALZEME Material
415123	TREYLER	DORSE AKS Trailer Axle	486137	-	-	-	107,95	152,55	-	11,90	-	L1	NBR
412216	SAURER TİP	DORSE AKS Trailer Axle	4373000200	-	01003416	-	110,00	128,00		9,00		SLL	NBR
415008	DORSE KEÇESİ	DORSE AKS Trailer Axle	-	-	-	-	110,00	160,00		15,00		L3	NBR
415248	DORSE KEÇESİ	DORSE AKS Trailer Axle	14023787	-	01003482	-	118,00	160,00		13,00		SLL	NBR
415018	DORSE KEÇESİ	DORSE AKS Trailer Axle	-	-	12011076	-	120,00	160,00		12,00		L3	NBR
415247	DORSE KEÇESİ	DORSE AKS Trailer Axle	-	-	-	-	120,00	160,00		13,00		SLL	NBR
415130	BORONKAY DORSE	DORSE AKS Trailer Axle	230007		-	-	120,00	162,00		13,00		CLL3	NBR
415069	DORSE - MERCEDES İLAVE AKS	DORSE AKS Trailer Axle	0019973847	0029974046	12011406	044.687	125,00	152,40		15,00		SL	NBR
415029	DORSE - CHRYSLER İLAVE AKS	DORSE AKS Trailer Axle	-	-	-	-	120,65	152,57		15,87		SL	NBR
415052	DORSE - BMC İLAVE AKS	DORSE AKS Trailer Axle	-	-	-	-	128,59	155,83		12,70		L3	NBR

ŞANZIMAN - Gearbox (Model Sıralı / Sorted by Model)

SKT NO	KULLANILAN MODELLER Models	KULLANIM YERİ Place Of Use	ORJİNAL NO 1 Original No 1	ORJİNAL NO 2 Original No 2	EŞDEĞER NO 1 Equivalent No 1	EŞDEĞER NO 2 Equivalent No 2	ÖLÇÜLER - MM. Dimensions - MM.					TİP Type	MALZEME Material
045827-V	16S 109	ŞANZIMAN ÖN Gearbox Front	0750 111 149	0734310161	12012045	-	48,00	65,00		10,00		L13TL SAĞ -Right	FKM
046011	16S 109	ŞANZIMAN ÖN Gearbox Front	0501 311 146	-	01017792	-	60,00	74,80		4,8		SPL5	NBR
410403-V	16S 109	ŞANZIMAN ARKA İÇ Gearbox Rear - Inner	0734 319 459	-	01026691	-	105,00	125,00		12,00	9,50	L13TL SOL -Left	FKM
040745	16S 109	VİTES SEÇİCİ MİLİ Gear Selection Shaft	0634 300 302	-	12014616	038.083	25,00	35,00		7,00		L3TL	NBR
041177	16S 109	VİTES SEÇİCİ MİLİ Gear Selection Shaft	0634 300 302	-	12014616	038.083	25,00	35,00		7,00		L13TL	NBR
041110-V	16S 109	TAKVİYE HİLAL MİLİ Reinforcement Shaft	0750 112 047	-	01029805	-	22,00	36,00	48,00	14,5		SPL3CTL	FKM
045840-V	16S 130	ŞANZIMAN ÖN Gearbox Front	0750 111 002	0734310110	12011307	033.472	48,00	75,00		8,00		L1 SAĞ-Right	FKM
046115-P	16S 130	ŞANZIMAN ÖN Gearbox Front	0734 310 387	-	01031969	515.340	55,00	75,00		8,00		L1R SAĞ -Right	ACM
047811-V	16S 130	ŞANZIMAN ÖN Gearbox Front	0734 300 140	-	12014700	763.144	70,00	90,00		10,00		L13TL SAĞ -Right	FKM
412344-P	16S 130	ŞANZIMAN ARKA Gearbox Rear	0750 111 341	0734319551	01016923	490.840	105,00	130,00		12,00		L13TL SOL -Left	ACM
412344-V	16S 130	ŞANZIMAN ARKA Gearbox Rear	0750 111 341	0734319551	01016923	490.840	105,00	130,00		12,00		L13TL SOL -Left	FKM
041051-V	16S 130	TAKVİYE HİLAL MİLİ Reinforcement Shaft	0750 112 034	0501306439	12015769	457.290	25,00	38,00	49,50	14,5		SPL3TL	FKM
041109-V	16S 130	TAKVİYE HİLAL MİLİ Reinforcement Shaft	0750 112 034	0501306439	12015769	457.290	25,00	38,00	49,50	14,5		SPL3CTL	FKM
047684-V	16S 130	PTO MİLİ Power Take Off Shaft	0734319046	-	01026471	-	55,00	80,00		8,00		L3L	FKM
412290-V	16S 130	ŞANZIMAN ARKA-DIŞ Gearbox Rear - Outer	0734310124	0734319253	01016923	490.840	105,00	130,00		11,00		L13L SOL -Left	FKM
046115-P	16S 150	ŞANZIMAN ÖN Gearbox Front	0734 310 387	-	01031969	-	55,00	75,00		8,00		L1R SAĞ -Right	ACM
047811-V	16S 150	ŞANZIMAN ÖN Gearbox Front	0734 300 140	-	12014700	763.144	70,00	90,00		10,00		L13TL SAĞ -Right	FKM
412344-P	16S 150	ŞANZIMAN ARKA Gearbox Rear	0750 111 341	0734319551	01016923	490.840	105,00	130,00		12,00		L13TL SOL -Left	ACM

ŞANZİMAN - Gearbox (Model Sıralı / Sorted by Model)

SKT NO	KULLANILAN MODELLER Models	KULLANIM YERİ Place Of Use	ORJİNAL NO 1 Original No 1	ORJİNAL NO 2 Original No 2	EŞDEĞER NO 1 Equivalent No 1	EŞDEĞER NO 2 Equivalent No 2	ÖLÇÜLER - MM. Dimensions - MM.					TİP Type	MALZEME Material
412344-V	16S 150	ŞANZİMAN ARKA Gearbox Rear	0750 111 341	0734319551	01016923	490.840	105,00	130,00		12,00		L13TL SOL -Left	FKM
047830-P	16S 150	ŞANZ.YARD. MİLİ Gearbox Auxiliary Shaft	0501 314 060	0501320435	01017789	-	77,00	95,50		6,00		L5	ACM
041051-V	16S 150	TAKVİYE HİLAL MİLİ Reinforcement Shaft	0750 112 034	0501306439	12015769	457.290	25,00	38,00	49,50	14,5		SPL3TL	FKM
041109-V	16S 150	TAKVİYE HİLAL MİLİ Reinforcement Shaft	0750 112 034	0501306439	12015769	457.290	25,00	38,00	49,50	14,5		SPL3CTL	FKM
045964-V	16S 151	ŞANZİMAN ÖN Gearbox Front	0734 310 104	-	12018806	141.960	52,00	68,00		8,00		L13TL SAĞ -Right	FKM
046027-V	16S 151	ŞANZİMAN ÖN Gearbox Front	0734310104	-	01029746	12018806	52,00	68,00		8,00		L3T SAĞ -Right	FKM
045851-V	16S 151	ŞANZİMAN ÖN Gearbox Front	0734 310 386	0734310111	12011308	284.645	55,00	75,00		8,00		L1 SAĞ-Right	FKM
046115-P	16S 151	ŞANZİMAN ÖN Gearbox Front	0734 310 387	-	01031969	-	55,00	75,00		8,00		L1R SAĞ -Right	ACM
412344-P	16S 151	ŞANZİMAN ARKA Gearbox Rear	0750 111 341	0734319551	01016923	490.840	105,00	130,00		12,00		L13TL SOL -Left	ACM
412344-V	16S 151	ŞANZİMAN ARKA Gearbox Rear	0750 111 341	0734319551	01016923	490.840	105,00	130,00		12,00		L13TL SOL -Left	FKM
047830-P	16S 151	ŞANZ.YARD. MİLİ Gearbox Auxiliary Shaft	0501 314 060	0501310435	01017789	-	77,00	95,50		6,00		L5	ACM
040745	16S 151	VİTES SEÇİCİ MİLİ Gear Selection Shaft	0634 300 302	-	12014616	038.083	25,00	35,00		7,00		L3TL	NBR
041177	16S 151	VİTES SEÇİCİ MİLİ Gear Selection Shaft	0634 300 302	-	12014616	038.083	25,00	35,00		7,00		L13TL	NBR
041108-NL	16S 151	VİTES SEÇİCİ MİLİ Gear Selection Shaft	0734309376	0734309765	01030095	-	28,00	42,00		11,00		SPL13CTLL	NBR+TPU
041113	16S 151	DEBRİYAL MİLİ Clutch Shaft	0501 312 738	-	12015561	-	30,00	37,00		4,00		L2T	NBR
041109-V	16S 151	TAKVİYE HİLAL MİLİ Reinforcement Shaft	0750 112 034	0501306439	12015769	457.290	25,00	38,00	49,50	14,2		SPL3CTL	FKM
041051-V	16S 151	TAKVİYE HİLAL MİLİ Reinforcement Shaft	0750 112 034	0501306439	12015769	457.290	25,00	38,00	49,50	14,5		SPL3TL	FKM
041106-V	16S 151	TAKVİYE HİLAL MİLİ Reinforcement Shaft	0750 112 253	0750112131	01029609	733.480	25,00	40,00	49,70	15,00		SPL13CTL	FKM

ŞANZİMAN - Gearbox (Model Sıralı / Sorted by Model)

SKT NO	KULLANILAN MODELLER Models	KULLANIM YERİ Place Of Use	ORJİNAL NO 1 Original No 1	ORJİNAL NO 2 Original No 2	EŞDEĞER NO 1 Equivalent No 1	EŞDEĞER NO 2 Equivalent No 2	ÖLÇÜLER - MM. Dimensions - MM.				TİP Type	MALZEME Material	
4MH-415-H	16S 151	TAKVİYE HAVA PİST. Reinforcement Air Piston	0750 112 177	-	01034594	-	63,00	55,00		9,40		L	HNBR
412290-V	16S 151	ŞANZİMAN ARKA-DIŞ Gearbox Rear - Outer	0734310124	0734319253	01016923	490.840	105,00	130,00		11,00		L13L SOL -Left	FKM
4P-228-H	16S 151	ŞANZ. AKTAR. PİSTONU Gearbox Piston	0734307294	-	49378203	-	50,00	90,00		7,50		PC	HNBR
045840-V	16S 160	ŞANZİMAN ÖN Gearbox Front	0750 111 002	0734310110	12011307	033.472	48,00	75,00		8,00		L1 SAĞ-Right	FKM
046115-P	16S 160	ŞANZİMAN ÖN Gearbox Front	0734 310 387	-	01031969	-	55,00	75,00		8,00		L1R SAĞ -Right	ACM
047811-V	16S 160	ŞANZİMAN ÖN Gearbox Front	0734 300 140	-	12014700	763.144	70,00	90,00		10,00		L13TL SAĞ -Right	FKM
412344-P	16S 160	ŞANZİMAN ARKA Gearbox Rear	0750 111 341	0734319551	01016923	490.840	105,00	130,00		12,00		L13TL SOL -Left	ACM
412344-V	16S 160	ŞANZİMAN ARKA Gearbox Rear	0750 111 341	0734319551	01016923	490.840	105,00	130,00		12,00		L13TL SOL -Left	FKM
046115-P	16S 1620	ŞANZİMAN ÖN Gearbox Front	0734 310 387	-	01031969	-	55,00	75,00		8,00		L1R SAĞ -Right	ACM
412344-P	16S 1620	ŞANZİMAN ARKA Gearbox Rear	0750 111 341	0734319551	01016923	490.840	105,00	130,00		12,00		L13TL SOL -Left	ACM
412344-V	16S 1620	ŞANZİMAN ARKA Gearbox Rear	0750 111 341	0734319551	01016923	490.840	105,00	130,00		12,00		L13TL SOL -Left	FKM
047830-P	16S 1620	ŞANZ.YARD. MİLİ Gearbox Auxiliary Shaft	0501 314 060	0501300435	01017789	-	77,00	95,50		6,00		L5	ACM
041106-V	16S 1620	TAKVİYE HİLAL MİLİ Reinforcement Shaft	0750 112 253	0750112131	01029609	733.480	25,00	40,00	49,70	15,00		SPL13CTL	FKM
4MH-415-H	16S 1620	TAKVİYE HAVA PİST. Reinforcement Air Piston	0750 112 177	-	01034594	-	55,00	63,00		9,40		L	HNBR
046115-P	16S 181	ŞANZİMAN ÖN Gearbox Front	0734 310 387	-	01031969	-	55,00	75,00		8,00		L1R SAĞ -Right	ACM
412344-P	16S 181	ŞANZİMAN ARKA Gearbox Rear	0750 111 341	0734319551	01016923	490.840	105,00	130,00		12,00		L13TL SOL -Left	ACM
412344-V	16S 181	ŞANZİMAN ARKA Gearbox Rear	0750 111 341	0734319551	01016923	490.840	105,00	130,00		12,00		L13TL SOL -Left	FKM
041106-V	16S 181	TAKVİYE HİLAL MİLİ Reinforcement Shaft	0750 112 253	0750112131	01029609	733.480	25,00	40,00	49,70	15,00		SPL13CTL	FKM

ŞANZİMAN - Gearbox (Model Sıralı / Sorted by Model)

SKT NO	KULLANILAN MODELLER Models	KULLANIM YERİ Place Of Use	ORJİNAL NO 1 Original No 1	ORJİNAL NO 2 Original No 2	EŞDEĞER NO 1 Equivalent No 1	EŞDEĞER NO 2 Equivalent No 2	ÖLÇÜLER - MM. Dimensions - MM.				TİP Type	MALZEME Material	
4MH-415-H	16S 181	TAKVİYE HAVA PİST. Reinforcement Air Piston	0750 112 177	-	01034594	-	55,00	63,00		9,40		-	HNBR
4P-228-H	16S 181	ŞANZ. AKTAR. PİSTONU Gearbox Piston	0734307294	-	49378203	-	50,00	90,00		7,50		PC	HNBR
046115-P	16S 1820-1920	ŞANZİMAN ÖN Gearbox Front	0734 310 387	-	01031969	-	55,00	75,00		8,00		L1R SAĞ -Right	ACM
412344-P	16S 1820-1920	ŞANZİMAN ARKA Gearbox Rear	0750 111 341	0734319551	01016923	490.840	105,00	130,00		12,00		L13TL SOL -Left	ACM
412344-V	16S 1820-1920	ŞANZİMAN ARKA Gearbox Rear	0750 111 341	0734319551	01016923	490.840	105,00	130,00		12,00		L13TL SOL -Left	FKM
047830-P	16S 1820-1920	ŞANZ.YARD. MİLİ Gearbox Auxiliary Shaft	0501 314 060	0501290435	01017789	-	77,00	95,50		6,00		L5	ACM
041106-V	16S 1820-1920	TAKVİYE HİLAL MİLİ Reinforcement Shaft	0750 112 253	0750112131	01029609	733.480	25,00	40,00	49,70	15,00		SPL13CTL	FKM
4MH-415-H	16S 1820-1920	TAKVİYE HAVA PİST. Reinforcement Air Piston	0750 112 177	-	01034594	-	55,00	63,00		9,40		L	HNBR
040820	16S 1820-1920	VİTES SEÇİCİ MİLİ Gear Selection Shaft	0770080256	0770198108	12016820	-	20,00	30,00		7,00	8,00	L3BTL	NBR
046115-P	16S 190	ŞANZİMAN ÖN Gearbox Front	0734 310 387	-	01031969	-	55,00	75,00		8,00		L1R SAĞ -Right	ACM
047811-V	16S 190	ŞANZİMAN ÖN Gearbox Front	0734 300 140	-	12014700	763.144	70,00	90,00		10,00		L13TL SAĞ -Right	FKM
412344-P	16S 190	ŞANZİMAN ARKA Gearbox Rear	0750 111 341	0734319551	01016923	490.840	105,00	130,00		12,00		L13TL SOL -Left	ACM
412344-V	16S 190	ŞANZİMAN ARKA Gearbox Rear	0750 111 341	0734319551	01016923	490.840	105,00	130,00		12,00		L13TL SOL -Left	FKM
041109-V	16S 190	TAKVİYE HİLAL MİLİ Reinforcement Shaft	0750 112 034	0501306439	12015769	457.290	25,00	38,00	49,50	14,2		SPL3CTL	FKM
041051-V	16S 190	TAKVİYE HİLAL MİLİ Reinforcement Shaft	0750 112 034	0501306439	12015769	457.290	25,00	38,00	49,50	14,5		SPL3TL	FKM
046115-P	16S 220	ŞANZİMAN ÖN Gearbox Front	0734 310 387	-	01031969	-	55,00	75,00		8,00		L1R SAĞ -Right	ACM
046115-P	16S 220	ŞANZİMAN ÖN Gearbox Front	0734 310 387	-	01031969	-	55,00	75,00		8,00		L1R SAĞ -Right	ACM
412344-P	16S 220	ŞANZİMAN ARKA Gearbox Rear	0750 111 341	0734319551	01016923	490.840	105,00	130,00		12,00		L13TL SOL -Left	ACM

ŞANZIMAN - Gearbox (Model Sıralı / Sorted by Model)

SKT NO	KULLANILAN MODELLER Models	KULLANIM YERİ Place Of Use	ORJİNAL NO 1 Original No 1	ORJİNAL NO 2 Original No 2	EŞDEĞER NO 1 Equivalent No 1	EŞDEĞER NO 2 Equivalent No 2	ÖLÇÜLER - MM. Dimensions - MM.					TİP Type	MALZEME Material
412344-P	16S 220	ŞANZIMAN ARKA Gearbox Rear	0750 111 341	0734319551	01016923	490.840	105,00	130,00		12,00		L13TL SOL -Left	ACM
412344-V	16S 220	ŞANZIMAN ARKA Gearbox Rear	0750 111 341	0734319551	01016923	490.840	105,00	130,00		12,00		L13TL SOL -Left	FKM
412344-V	16S 220	ŞANZIMAN ARKA Gearbox Rear	0750 111 341	0734319551	01016923	490.840	105,00	130,00		12,00		L13TL SOL -Left	FKM
047830-P	16S 220	ŞANZ.YARD. MİLİ Gearbox Auxiliary Shaft	0501 314 060	0501280435	01017789	-	77,00	95,50		6,00		L5	ACM
047830-P	16S 220	ŞANZ.YARD. MİLİ Gearbox Auxiliary Shaft	0501 314 060	0501250435	01017789	-	77,00	95,50		6,00		L5	ACM
041109-V	16S 220	TAKVİYE HİLAL MİLİ Reinforcement Shaft	0750 112 034	0501306439	12015769	457.290	25,00	38,00	49,50	14,2		SPL3CTL	FKM
041051-V	16S 220	TAKVİYE HİLAL MİLİ Reinforcement Shaft	0750 112 034	0501306439	12015769	457.290	25,00	38,00	49,50	14,5		SPL3TL	FKM
041106-V	16S 220	TAKVİYE HİLAL MİLİ Reinforcement Shaft	0750 112 253	0750112131	01029609	733.480	25,00	40,00	49,70	15,00		SPL13CTL	FKM
041106-V	16S 220	TAKVİYE HİLAL MİLİ Reinforcement Shaft	0750 112 253	0750112131	01029609	733.480	25,00	40,00	49,70	15,00		SPL13CTL	FKM
4MH-415-H	16S 220	TAKVİYE HAVA PİST. Reinforcement Air Piston	0750 112 177	-	01034594	-	55,00	63,00		9,40		L	HNBR
040820	16S 220	VİTES SEÇİCİ MİLİ Gear Selection Shaft	0770080256	0770198108	12016820	-	20,00	30,00		7,00	8,00	L3BTL	NBR
045964-V	16S 221	ŞANZIMAN ÖN Gearbox Front	0734 310 104	-	12018806	141.960	52,00	68,00		8,00		L13TL SAĞ -Right	FKM
046115-P	16S 221	ŞANZIMAN ÖN Gearbox Front	0734 310 387	-	01031969	-	55,00	75,00		8,00		L1R SAĞ -Right	ACM
412344-P	16S 221	ŞANZIMAN ARKA Gearbox Rear	0750 111 341	0734319551	01016923	490.840	105,00	130,00		12,00		L13TL SOL -Left	ACM
412344-V	16S 221	ŞANZIMAN ARKA Gearbox Rear	0750 111 341	0734319551	01016923	490.840	105,00	130,00		12,00		L13TL SOL -Left	FKM
047830-P	16S 221	ŞANZ.YARD. MİLİ Gearbox Auxiliary Shaft	0501 314 060	0501270435	01017789	-	77,00	95,50		6,00		L5	ACM
041106-V	16S 221	TAKVİYE HİLAL MİLİ Reinforcement Shaft	0750 112 253	0750112131	01029609	733.480	25,00	40,00	49,70	15,00		SPL13CTL	FKM
4MH-415-H	16S 221	TAKVİYE HAVA PİST. Reinforcement Air Piston	0750 112 177	-	01034594	-	55,00	63,00		9,40		L	HNBR

ŞANZİMAN - Gearbox (Model Sıralı / Sorted by Model)

SKT NO	KULLANILAN MODELLER Models	KULLANIM YERİ Place Of Use	ORJİNAL NO 1 Original No 1	ORJİNAL NO 2 Original No 2	EŞDEĞER NO 1 Equivalent No 1	EŞDEĞER NO 2 Equivalent No 2	ÖLÇÜLER - MM. Dimensions - MM.					TİP Type	MALZEME Material
040820	16S 221	VİTES SEÇİCİ MİLİ Gear Selection Shaft	0770080256	0770198108	12016820	-	20,00	30,00		7,00	8,00	L3BTL	NBR
4P-228-H	16S 221	ŞANZ. AKTAR. PİSTONU Gearbox Piston	0734307294	-	49378203	-	50,00	90,00		7,50		PC	HNBR
4P-228-H	16S 2220	ŞANZ. AKTAR. PİSTONU Gearbox Piston	0734307294	-	49378203	-	50,00	90,00		7,50		PC	HNBR
4P-228-H	16S 2221	ŞANZ. AKTAR. PİSTONU Gearbox Piston	0734307294	-	49378203	-	50,00	90,00		7,50		PC	HNBR
046115-P	16S 2320	ŞANZİMAN ÖN Gearbox Front	0734 310 387	-	01031969	-	55,00	75,00		8,00		L1R SAÇ -Right	ACM
412344-P	16S 2320	ŞANZİMAN ARKA Gearbox Rear	0750 111 341	0734319551	01016923	490.840	105,00	130,00		12,00		L13TL SOL -Left	ACM
412344-V	16S 2320	ŞANZİMAN ARKA Gearbox Rear	0750 111 341	0734319551	01016923	490.840	105,00	130,00		12,00		L13TL SOL -Left	FKM
047830-P	16S 2320	ŞANZ.YARD. MİLİ Gearbox Auxiliary Shaft	0501 314 060	0501240435	01017789	-	77,00	95,50		6,00		L5	ACM
041106-V	16S 2320	TAKVİYE HİLAL MİLİ Reinforcement Shaft	0750 112 253	0750112131	01029609	733.480	25,00	40,00	49,70	15,00		SPL13CTL	FKM
4MH-415-H	16S 2320	TAKVİYE HAVA PİST. Reinforcement Air Piston	0750 112 177	-	01034594	-	55,00	63,00		9,40		L	HNBR
040820	16S 2320	VİTES SEÇİCİ MİLİ Gear Selection Shaft	0770080256	0770198108	12016820	-	20,00	30,00		7,00	8,00	L3BTL	NBR
4P-228-H	16S 2320	ŞANZ. AKTAR. PİSTONU Gearbox Piston	0734307294	-	49378203	-	50,00	90,00		7,50		PC	HNBR
046115-P	16S 251	ŞANZİMAN ÖN Gearbox Front	0734 310 387	-	01031969	-	55,00	75,00		8,00		L1R SAÇ -Right	ACM
412344-P	16S 251	ŞANZİMAN ARKA Gearbox Rear	0750 111 341	0734319551	01016923	490.840	105,00	130,00		12,00		L13TL SOL -Left	ACM
412344-V	16S 251	ŞANZİMAN ARKA Gearbox Rear	0750 111 341	0734319551	01016923	490.840	105,00	130,00		12,00		L13TL SOL -Left	FKM
047830-P	16S 251	ŞANZ.YARD. MİLİ Gearbox Auxiliary Shaft	0501 314 060	0501260435	01017789	-	77,00	95,50		6,00		L5	ACM
041106-V	16S 251	TAKVİYE HİLAL MİLİ Reinforcement Shaft	0750 112 253	0750112131	01029609	733.480	25,00	40,00	49,70	15,00		SPL13CTL	FKM

ŞANZİMAN - Gearbox (Model Sıralı / Sorted by Model)

SKT NO	KULLANILAN MODELLER Models	KULLANIM YERİ Place Of Use	ORJİNAL NO 1 Original No 1	ORJİNAL NO 2 Original No 2	EŞDEĞER NO 1 Equivalent No 1	EŞDEĞER NO 2 Equivalent No 2	ÖLÇÜLER - MM. Dimensions - MM.				TİP Type	MALZEME Material	
4MH-415-H	16S 251	TAKVİYE HAVA PİST. Reinforcement Air Piston	0750 112 177	-	01034594	-	55,00	63,00		9,40		L	HNBR
046115-P	16S 2520	ŞANZİMAN ÖN Gearbox Front	0734 310 387	-	01031969	-	55,00	75,00		8,00		L1R SAĞ -Right	ACM
412344-P	16S 2520	ŞANZİMAN ARKA Gearbox Rear	0750 111 341	0734319551	01016923	490.840	105,00	130,00		12,00		L13TL SOL -Left	ACM
412344-V	16S 2520	ŞANZİMAN ARKA Gearbox Rear	0750 111 341	0734319551	01016923	490.840	105,00	130,00		12,00		L13TL SOL -Left	FKM
047830-P	16S 2520	ŞANZ.YARD. MİLİ Gearbox Auxiliary Shaft	0501 314 060	0501230435	01017789	-	77,00	95,50		6,00		L5	ACM
041106-V	16S 2520	TAKVİYE HİLAL MİLİ Reinforcement Shaft	0750 112 253	0750112131	01029609	733.480	25,00	40,00	49,70	15,00		SPL13CTL	FKM
4MH-415-H	16S 2520	TAKVİYE HAVA PİST. Reinforcement Air Piston	0750 112 177	-	01034594	-	55,00	63,00		9,40		L	HNBR
4P-228-H	16S 2520	ŞANZ. AKTAR. PİSTONU Gearbox Piston	0734307294	-	49378203	-	50,00	90,00		7,50		PC	HNBR
046115-P	16S 2723	ŞANZİMAN ÖN Gearbox Front	0734 310 387	-	01031969	-	55,00	75,00		8,00		L1R SAĞ -Right	ACM
412344-P	16S 2723	ŞANZİMAN ARKA Gearbox Rear	0750 111 341	0734319551	01016923	490.840	105,00	130,00		12,00		L13TL SOL -Left	ACM
412344-V	16S 2723	ŞANZİMAN ARKA Gearbox Rear	0750 111 341	0734319551	01016923	490.840	105,00	130,00		12,00		L13TL SOL -Left	FKM
047830-P	16S 2723	ŞANZ.YARD. MİLİ Gearbox Auxiliary Shaft	0501 314 060	0501220435	01017789	-	77,00	95,50		6,00		L5	ACM
041106-V	16S 2723	TAKVİYE HİLAL MİLİ Reinforcement Shaft	0750 112 253	0750112131	01029609	733.480	25,00	40,00	49,70	15,00		SPL13CTL	FKM
4MH-415-H	16S 2723	TAKVİYE HAVA PİST. Reinforcement Air Piston	0750 112 177	-	01034594	-	55,00	63,00		9,40		L	HNBR
046132-P	6S 35	ŞANZİMAN ÖN Gearbox Front	0750 111 476	0734319713	12013896	040.363	42,00	62,00		10,00		L3TL SAĞ -Right	ACM
045827-V	6S 35	ŞANZİMAN ÖN Gearbox Front	0750 111 149	0734310161	20016209	-	48,00	65,00		10,00		L13TL SAĞ -Right	FKM
040745	6S 35	VİTES SEÇİCİ MİLİ Gear Selection Shaft	0634 300 302	-	12014616	038.083	25,00	35,00		7,00		L3TL	NBR
041177	6S 35	VİTES SEÇİCİ MİLİ Gear Selection Shaft	0634 300 302	-	12014616	038.083	25,00	35,00		7,00		L13TL	NBR

ŞANZİMAN - Gearbox (Model Sıralı / Sorted by Model)

SKT NO	KULLANILAN MODELLER Models	KULLANIM YERİ Place Of Use	ORJİNAL NO 1 Original No 1	ORJİNAL NO 2 Original No 2	EŞDEĞER NO 1 Equivalent No 1	EŞDEĞER NO 2 Equivalent No 2	ÖLÇÜLER - MM. Dimensions - MM.					TİP Type	MALZEME Material
041109-V	6S 35	TAKVİYE HİLAL MİLİ Reinforcement Shaft	0750 112 034	0501306439	12015769	457.290	25,00	38,00	49,50	14,5		SPL3CTL	FKM
046132-P	6S 850	ŞANZİMAN ÖN Gearbox Front	0750 111 476	0734319713	12013896	040.363	42,00	62,00		10,00		L3TL SAĞ -Right	ACM
045827-V	6S 850	ŞANZİMAN ÖN Gearbox Front	0750 111 149	0734310161	20016209	-	48,00	65,00		10,00		L13TL SAĞ -Right	FKM
047843-V	6S 850	ŞANZİMAN ARKA Gearbox Rear	0734319104	0734310128	12014736	348.856	70,00	90,00		10,00		L3T SOL-Left	FKM
047645-V	6S 850	ŞANZİMAN ARKA Gearbox Rear	-	-	12013860	034.347	78,00	100,00		10,00		L13TL SOL -Left	FKM
040745	6S 850	VİTES SEÇİCİ MİLİ Gear Selection Shaft	0634 300 302	-	12014616	038.083	25,00	35,00		7,00		L3TL	NBR
041177	6S 850	VİTES SEÇİCİ MİLİ Gear Selection Shaft	0634 300 302	-	12014616	038.083	25,00	35,00		7,00		L13TL	NBR
041108-NL	6S 850	VİTES SEÇİCİ MİLİ Gear Selection Shaft	0734309376	0734309765	01030095	-	28,00	42,00		11,00		SPL13CTLL	NBR+TPU
045827-V	9S 109	ŞANZİMAN ÖN Gearbox Front	0750 111 149	0734310161	20016209	-	48,00	65,00		10,00		L13TL SAĞ -Right	FKM
046011	9S 109	ŞANZİMAN ÖN Gearbox Front	0501 311 146	-	01017792	-	60,00	74,80		4,8		SPL5	NBR
410403-V	9S 109	ŞANZİMAN ARKA İÇ Gearbox Rear - Inner	0734 319 459	-	01026691	-	105,00	125,00		12,00	9,50	L13TL SOL -Left	FKM
040745	9S 109	VİTES SEÇİCİ MİLİ Gear Selection Shaft	0634 300 302	-	12014616	038.083	25,00	35,00		7,00		L3TL	NBR
041177	9S 109	VİTES SEÇİCİ MİLİ Gear Selection Shaft	0634 300 302	-	12014616	038.083	25,00	35,00		7,00		L13TL	NBR
041110-V	9S 109	TAKVİYE HİLAL MİLİ Reinforcement Shaft	0750 112 047	-	01029805	-	22,00	36,00	48,00	14,5		SPL3CTL	FKM
4P-262-V	9S 109	TAKVİYE HAVA PİST. Reinforcement Air Piston	0750112089	-	504.540	5045400	53,00	63,00		16,30		PI	FKM
045990-V	9S 109	ŞANZİMAN ÖN Gearbox Front	0750111348	-	12015120	419.730	55,00	70,00		8,00		L13TL SAĞ -Right	FKM
045827-V	9S 75	ŞANZİMAN ÖN Gearbox Front	0750 111 149	0734310161	20016209	-	48,00	65,00		10,00		L13TL SAĞ -Right	FKM
046011	9S 75	ŞANZİMAN ÖN Gearbox Front	0501 311 146	-	01017792	-	60,00	74,80		4,7		SPL5	NBR

ŞANZİMAN - Gearbox (Model Sıralı / Sorted by Model)

SKT NO	KULLANILAN MODELLER Models	KULLANIM YERİ Place Of Use	ORJİNAL NO 1 Original No 1	ORJİNAL NO 2 Original No 2	EŞDEĞER NO 1 Equivalent No 1	EŞDEĞER NO 2 Equivalent No 2	ÖLÇÜLER - MM. Dimensions - MM.					TİP Type	MALZEME Material
047711-V	9S 75	ŞANZİMAN ARKA Gearbox Rear	0750111334	0734319306	20027765	587.966	80,00	100,00		10,00		L13TL SS-RL	FKM
040774-V	9S 75	KİLOMETRE MİLİ Speedometer Shaft	0634 300 185	0634300105	01002259	010.804	10,00	15,00		7,00		L5	FKM
040745	9S 75	VİTES SEÇİCİ MİLİ Gear Selection Shaft	0634 300 302	-	12014616	038.083	25,00	35,00		7,00		L3TL	NBR
041177	9S 75	VİTES SEÇİCİ MİLİ Gear Selection Shaft	0634 300 302	-	12014616	038.083	25,00	35,00		7,00		L13TL	NBR
041111-V	9S 75	TAKVİYE HİLAL MİLİ Reinforcement Shaft	0501316333	-	01032393	-	22,00	36,00	57,00	14,5		SPL3CTL	FKM
4P-260-H	9S 75	TAKVİYE HAVA PİST. Reinforcement Air Piston	0734 309 377	-	12014451	-	63,00	16,00		10,50		L5	HNBR
046021-VK	S5 42	ŞANZİMAN ÖN Gearbox Front	0734310396	-	01029649	12019650	40,00	52,00		8,50		L3TL SAĞ -Right	FKM +YÜN-NW
045330	S6 85	ŞANZİMAN ÖN Gearbox Front Outer	0634300543	0734300087	12011331	040.991	48,00	65,00		10,00		L1	NBR
045880-V	S6 85	ŞANZİMAN ÖN İÇ Gearbox Front	0734310043	0734310108	12011306	284.662	48,00	69,00		10,00		L1 SAĞ-Right	FKM
410386-V	S6 90	ŞANZİMAN ARKA Gearbox Rear	0734310109	0734310133	12013757	033.464	85,00	105,00		10,00		L3TL SOL -Left	FKM
410348-V	S6 90	ŞANZİMAN ARKA Gearbox Rear	0750111004	-	12013757	033.464	85,00	105,00		10,00		L1 SOL-Left	FKM
045880-V	S6 90	ŞANZİMAN ÖN İÇ Gearbox Front	0734310043	0734310108	12011306	284.662	48,00	69,00		10,00		L1 SAĞ-Right	FKM
040182	S6 90	ŞANZ. DEBRİYAJ KEÇESİ Clutch Shaft Seal	0634300053	-	12010784	164.500	14,00	24,00		7,00		L3	NBR
045636	2220-2620 SERİSİ	ŞANZİMAN ARKA Gearbox Rear	0634300197	0734300094	12011333	041.335	55,00	75,00		10,00		L1	NBR
410435-V	4HP590 ŞANZ.	ŞANZİMAN ARKA Gearbox Rear	0734319052	0750111018	20034608	-	90,00	125,00		12,00		L3TL SOL -Left	FKM
047839-VAE	S5-420	ŞANZİMAN ARKA Gearbox Rear	0734319104	0750111232	20027594	12014736	70,00	90,00	-	10,00	-	L3TL SOL -Left	FKM+AEM
410448-V	-	ŞANZİMAN ARKA Gearbox Rear	0734400422	-	-	-	105,00	125,00	-	12,00	16,00	L13TLR	FKM
420068-V	-	ŞANZİMAN ARKA Gearbox Rear	4181-291-046	-	-	-	164,00	213,00	-	22,10	-	SPL5	FKM

ŞANZIMAN - Gearbox (Model Sıralı / Sorted by Model)

SKT NO	KULLANILAN MODELLER Models	KULLANIM YERİ Place Of Use	ORJİNAL NO 1 Original No 1	ORJİNAL NO 2 Original No 2	EŞDEĞER NO 1 Equivalent No 1	EŞDEĞER NO 2 Equivalent No 2	ÖLÇÜLER - MM. Dimensions - MM.					TİP Type	MALZEME Material
045964-V	G100-12 AXOR-ATEGO	ŞANZIMAN ÖN Gearbox Front	024 997 2147	0119974247	12018806	141.960	52,00		68,00	8,00		L13TL SAĞ -Right	FKM
047711-V	G100-12 AXOR-ATEGO	ŞANZIMAN ARKA Gearbox Rear	020 997 9947	0089971947	01020467	-	80,00		100,00	10,00		L13TL SS-RL	FKM
047859-V	G100-12 AXOR-ATEGO	ŞANZIMAN ARKA Gearbox Rear	023 997 8847	-	01033293	-	80,00		100,00	15,50		L13LL SOL -Left	FKM
046022-V	G125-16 AXOR-ACTROS	ŞANZIMAN ÖN Gearbox Front	015 997 0347	0089971947	12015259	283.827	46,00		64,00	8,00		L13TL SAĞ -Right	FKM
045964-V	G125-16 AXOR-ACTROS	ŞANZIMAN ÖN Gearbox Front	015 997 1647	0159970647	12018806	141.960	52,00		68,00	8,00		L13TL SAĞ -Right	FKM
410376-V	G125-16 AXOR-ACTROS	ŞANZIMAN ARKA Gearbox Rear	015 997 4247	0139977347	01017136	141.950	95,00		115,00	13,00		L13TL SOL -Left	FKM
410402	G125-16 AXOR-ACTROS	ŞANZIMAN ARKA Gearbox Rear	013 997 5547	0139977247	01002889	457.450	95,00		115,00	13,00		L13TL SS-RL	NBR
046020-V	G131-9 AXOR-ATEGO	ŞANZIMAN ÖN Gearbox Front	023 997 7847	0199970347	12019647	220.900	56,00		72,00	8,00		L13TL SAĞ -Right	FKM
047859-V	G131-9 AXOR-ATEGO	ŞANZIMAN ARKA Gearbox Rear	023 997 8847	-	01033293	-	80,00		100,00	15,50		L13LL SOL -Left	FKM
410376-V	G135-16 TRAVEGO-TOURISMO	ŞANZIMAN ARKA Gearbox Rear	015 997 4247	0139977347	01017136	141.950	95,00		115,00	13,00		L13TL SOL -Left	FKM
410402	G135-16 TRAVEGO-TOURISMO	ŞANZIMAN ARKA Gearbox Rear	013 997 5547	0139977247	01002889	457.450	95,00		115,00	13,00		L13TL SS-RL	NBR
045964-V	G135-16 TRAVEGO-TOURISMO-403-404	ŞANZIMAN ÖN Gearbox Front	015 997 1647	0119974247	12018806	141.960	52,00		68,00	8,00		L13TL SAĞ -Right	FKM
410376-V	G155-9 TRAVEGO-TOURISMO	ŞANZIMAN ARKA Gearbox Rear	015 997 4247	0139977347	01017136	141.950	95,00		115,00	13,00		L13TL SOL -Left	FKM
410402	G155-9 TRAVEGO-TOURISMO	ŞANZIMAN ARKA Gearbox Rear	013 997 5547	0139977247	01002889	457.450	95,00		115,00	13,00		L13TL SS-RL	NBR
045964-V	G155-9 TRAVEGO-TOURISMO-403-404	ŞANZIMAN ÖN Gearbox Front	015 997 1647	0159970647	12018806	141.960	52,00		68,00	8,00		L13TL SAĞ -Right	FKM
046020-V	G190-6 TRAVEGO	ŞANZIMAN ÖN Gearbox Front	023 997 7847	0199970347	01029647	220.900	56,00		72,00	8,00		L13TL SAĞ -Right	FKM
047711-V	G190-6 TRAVEGO	ŞANZIMAN ARKA Gearbox Rear	020 997 9947	0159970547	01020467	-	80,00		100,00	10,00		L13TL SS-RL	FKM
047859-V	G190-6 TRAVEGO	ŞANZIMAN ARKA Gearbox Rear	023 997 8847	-	01033293	-	80,00		100,00	15,50		L13LL SOL -Left	FKM

ŞANZIMAN - Gearbox (Model Sıralı / Sorted by Model)

SKT NO	KULLANILAN MODELLER Models	KULLANIM YERİ Place Of Use	ORJİNAL NO 1 Original No 1	ORJİNAL NO 2 Original No 2	EŞDEĞER NO 1 Equivalent No 1	EŞDEĞER NO 2 Equivalent No 2	ÖLÇÜLER - MM. Dimensions - MM.				TİP Type	MALZEME Material	
410376-V	G190-6 TRAVEGO	ŞANZIMAN ARKA Gearbox Rear	013 997 7347	0139977347	01017136	141.950	95,00		115,00	13,00		L13TL SOL -Left	FKM
410451-V	G190-6 TRAVEGO	ŞANZIMAN ARKA Gearbox Rear	023 997 1647	0159977846	01029684	222.830	95,00		115,00	15,50		L13LL SOL -Left	FKM
046020-V	G210-16 AXOR-ATEGO	ŞANZIMAN ÖN Gearbox Front	023 997 7847	0199970347	01029647	220.900	56,00		72,00	8,00		L13TL SAĞ -Right	FKM
410227	G210-16 AXOR-ATEGO	ŞANZIMAN ÖN Gearbox Front	0049970646	-	12011340	556.807	85,00		105,00	10,00		L1	NBR
410376-V	G210-16 AXOR-ATEGO	ŞANZIMAN ARKA Gearbox Rear	015 997 4247	0139977347	01017136	141.950	95,00		115,00	13,00		L13TL SOL -Left	FKM
410402	G210-16 AXOR-ATEGO	ŞANZIMAN ARKA Gearbox Rear	013 997 5547	0139977247	01002889	457.450	95,00		115,00	13,00		L13TL SS-RL	NBR
412092-V	G210-16 AXOR-ATEGO	ŞANZIMAN ARKA Gearbox Rear	015 997 6647	0159976447	01014589	454.090	115,00		140,00	12,00		L3	FKM
046020-V	G210-6 TRAVEGO	ŞANZIMAN ÖN Gearbox Front	023 997 7847	0199970347	01029647	220.900	56,00		72,00	8,00		L13TL SAĞ -Right	FKM
047711-V	G210-6 TRAVEGO	ŞANZIMAN ARKA Gearbox Rear	020 997 9947	0159970547	01020467	-	80,00		100,00	10,00		L13TL SS-RL	FKM
047859-V	G210-6 TRAVEGO	ŞANZIMAN ARKA Gearbox Rear	023 997 8847	-	01033293	-	80,00		100,00	15,50		L13LL SOL -Left	FKM
410376-V	G210-6 TRAVEGO	ŞANZIMAN ARKA Gearbox Rear	013 997 7347	0139977347	01017136	141.950	95,00		115,00	13,00		L13TL SOL -Left	FKM
410451-V	G210-6 TRAVEGO	ŞANZIMAN ARKA Gearbox Rear	023 997 1647	0159977846	01029684	222.830	95,00		115,00	15,50		L13LL SOL -Left	FKM
045964-V	G210-8 ACTROS 1844-1848 AXOR 1840	ŞANZIMAN ÖN Gearbox Front	015 997 1647	0159970647	12018806	141.960	52,00		68,00	8,00		L13TL SAĞ -Right	FKM
410376-V	G210-8 ACTROS 1844-1848 AXOR 1840	ŞANZIMAN ARKA Gearbox Rear	013 997 5647	0139977347	01017136	141.950	95,00		115,00	13,00		L13TL SOL -Left	FKM
410402	G210-8 ACTROS 1844-1848 AXOR 1840	ŞANZIMAN ARKA Gearbox Rear	013 997 5547	0139977247	01002889	457.450	95,00		115,00	13,00		L13TL SS-RL	NBR
046020-V	G211-12 AXOR-ATEGO	ŞANZIMAN ÖN Gearbox Front	023 997 7847	0199970347	01029647	220.900	56,00		72,00	8,00		L13TL SAĞ -Right	FKM
410227	G211-12 AXOR-ATEGO	ŞANZIMAN ÖN Gearbox Front	0119978547	-	12011340	556.807	85,00		105,00	10,00		L1	NBR
410376-V	G211-12 AXOR-ATEGO	ŞANZIMAN ARKA Gearbox Rear	015 997 4247	0139977347	01017136	141.950	95,00		115,00	13,00		L13TL SOL -Left	FKM

ŞANZİMAN - Gearbox (Model Sıralı / Sorted by Model)

SKT NO	KULLANILAN MODELLER Models	KULLANIM YERİ Place Of Use	ORJİNAL NO 1 Original No 1	ORJİNAL NO 2 Original No 2	EŞDEĞER NO 1 Equivalent No 1	EŞDEĞER NO 2 Equivalent No 2	ÖLÇÜLER - MM. Dimensions - MM.				TİP Type	MALZEME Material	
410402	G211-12 AXOR-ATEGO	ŞANZİMAN ARKA Gearbox Rear	013 997 5547	0139977247	01002889	457.450	95,00		115,00	13,00		L13TL SS-RL	NBR
412092-V	G211-12 AXOR-ATEGO	ŞANZİMAN ARKA Gearbox Rear	015 997 6647	0159976447	01014589	454.090	115,00		140,00	12,00		L3	FKM
046020-V	G211-16 AXOR-ECONIC-ATEGO	ŞANZİMAN ÖN Gearbox Front	023 997 7847	0199970347	01029647	220.900	56,00		72,00	8,00		L13TL SAĞ -Right	FKM
410227	G211-16 AXOR-ECONIC-ATEGO	ŞANZİMAN ÖN Gearbox Front	0229978547	-	12011340	556.807	85,00		105,00	10,00		L1	NBR
410376-V	G211-16 AXOR-ECONIC-ATEGO	ŞANZİMAN ARKA Gearbox Rear	015 997 4247	0139977347	01017136	141.950	95,00		115,00	13,00		L13TL SOL -Left	FKM
410402	G211-16 AXOR-ECONIC-ATEGO	ŞANZİMAN ARKA Gearbox Rear	013 997 5547	0149971947	01002889	457.450	95,00		115,00	13,00		L13TL SS-RL	NBR
412092-V	G211-16 AXOR-ECONIC-ATEGO	ŞANZİMAN ARKA Gearbox Rear	015 997 6647	0159976447	01014589	454.090	115,00		140,00	12,00		L3	FKM
046020-V	G211-9 AXOR-ACTROS	ŞANZİMAN ÖN Gearbox Front	023 997 7847	0199970347	01029647	220.900	56,00		72,00	8,00		L13TL SAĞ -Right	FKM
410376-V	G211-9 AXOR-ACTROS	ŞANZİMAN ARKA Gearbox Rear	015 997 4247	0139977347	01017136	141.950	95,00		115,00	13,00		L13TL SOL -Left	FKM
410402	G211-9 AXOR-ACTROS	ŞANZİMAN ARKA Gearbox Rear	013 997 5547	0139977247	01002889	457.450	95,00		115,00	13,00		L13TL SS-RL	NBR
412092-V	G211-9 AXOR-ACTROS	ŞANZİMAN ARKA Gearbox Rear	017 997 1247	0159976447	01014589	454.090	115,00		140,00	12,00		L3 (ALT)	FKM
046020-V	G231-16 AXOR-ACTROS-ATEGO	ŞANZİMAN ÖN Gearbox Front	023 997 7847	0199970347	01029647	220.900	56,00		72,00	8,00		L13TL SAĞ -Right	FKM
410376-V	G231-16 AXOR-ACTROS-ATEGO	ŞANZİMAN ARKA Gearbox Rear	015 997 4247	0139975647	01017136	141.950	95,00		115,00	13,00		L13TL SOL -Left	FKM
410402	G231-16 AXOR-ACTROS-ATEGO	ŞANZİMAN ARKA Gearbox Rear	013 997 5547	0139977247	01002889	457.450	95,00		115,00	13,00		L13TL SS-RL	NBR
412092-V	G231-16 AXOR-ACTROS-ATEGO	ŞANZİMAN ARKA Gearbox Rear	017 997 1247	0159976447	01014589	454.090	115,00		140,00	12,00		L3 (ALT)	FKM
046020-V	G240-16 AXOR-ACTROS-ATEGO	ŞANZİMAN ÖN Gearbox Front	023 997 7847	0199970347	01029647	220.900	56,00		72,00	8,00		L13TL SAĞ -Right	FKM
410376-V	G240-16 AXOR-ACTROS-ATEGO	ŞANZİMAN ARKA Gearbox Rear	015 997 4247	0139977347	01017136	141.950	95,00		115,00	13,00		L13TL SOL -Left	FKM
410402	G240-16 AXOR-ACTROS-ATEGO	ŞANZİMAN ARKA Gearbox Rear	013 997 5547	0149971947	01002889	457.450	95,00		115,00	13,00		L13TL SS-RL	NBR

ŞANZIMAN - Gearbox (Model Sıralı / Sorted by Model)

SKT NO	KULLANILAN MODELLER Models	KULLANIM YERİ Place Of Use	ORJİNAL NO 1 Original No 1	ORJİNAL NO 2 Original No 2	EŞDEĞER NO 1 Equivalent No 1	EŞDEĞER NO 2 Equivalent No 2	ÖLÇÜLER - MM. Dimensions - MM.				TİP Type	MALZEME Material	
412092-V	G240-16 AXOR-ACTROS-ATEGO	ŞANZIMAN ARKA Gearbox Rear	017 997 1247	0159976447	01014589	454.090	115,00		140,00	12,00		L3 (ALT)	FKM
046020-V	G260-16 AXOR-ACTROS-ATEGO	ŞANZIMAN ÖN Gearbox Front	023 997 7847	0199970347	01029647	220.900	56,00		72,00	8,00		L13TL SAĞ -Right	FKM
410376-V	G260-16 AXOR-ACTROS-ATEGO	ŞANZIMAN ARKA Gearbox Rear	015 997 4247	0139977347	01017136	141.950	95,00		115,00	13,00		L13TL SOL -Left	FKM
410402	G260-16 AXOR-ACTROS-ATEGO	ŞANZIMAN ARKA Gearbox Rear	013 997 5547	0139977247	01002889	457.450	95,00		115,00	13,00		L13TL SS-RL	NBR
412092-V	G260-16 AXOR-ACTROS-ATEGO	ŞANZIMAN ARKA Gearbox Rear	017 997 1247	0159976447	01014589	454.090	115,00		140,00	12,00		L3 (ALT)	FKM
046020-V	G0170-6 TRAVEGO	ŞANZIMAN ÖN Gearbox Front	023 997 7847	0199970347	01029647	220.900	56,00		72,00	8,00		L13TL SAĞ -Right	FKM
047711-V	G0170-6 TRAVEGO	ŞANZIMAN ARKA Gearbox Rear	020 997 9947	0209970247	01020467	-	80,00		100,00	10,00		L13TL SS-RL	FKM
047859-V	G0170-6 TRAVEGO	ŞANZIMAN ARKA Gearbox Rear	023 997 8847	-	01033293	-	80,00		100,00	15,50		L13LL SOL -Left	FKM
410376-V	G0170-6 TRAVEGO	ŞANZIMAN ARKA Gearbox Rear	013 997 7347	0139977347	01017136	141.950	95,00		115,00	13,00		L13TL SOL -Left	FKM
410451-V	G0170-6 TRAVEGO	ŞANZIMAN ARKA Gearbox Rear	023 997 1647	0159977846	01029684	222.830	95,00		115,00	15,50		L13LL SOL -Left	FKM
046020-V	G0230-16 TRAVEGO	ŞANZIMAN ÖN Gearbox Front	023 997 7847	0199970347	01029647	220.900	56,00		72,00	8,00		L13TL SAĞ -Right	FKM
047711-V	G0230-16 TRAVEGO	ŞANZIMAN ARKA Gearbox Rear	020 997 9947	0159970547	01020467	-	80,00		100,00	10,00		L13TL SS-RL	FKM
047859-V	G0230-16 TRAVEGO	ŞANZIMAN ARKA Gearbox Rear	023 997 8847	-	01033293	-	80,00		100,00	15,50		L13LL SOL -Left	FKM
410376-V	G0230-16 TRAVEGO	ŞANZIMAN ARKA Gearbox Rear	013 997 7347	0139977347	01017136	141.950	95,00		115,00	13,00		L13TL SOL -Left	FKM
410451-V	G0230-16 TRAVEGO	ŞANZIMAN ARKA Gearbox Rear	023 997 1647	0159977846	01029684	222.830	95,00		115,00	15,50		L13LL SOL -Left	FKM

RETARDER / Retarder

SKT NO	KULLANILAN MODELLER Models	KULLANIM YERİ Place Of Use	ORJİNAL NO 1 Original No 1	ORJİNAL NO 2 Original No 2	EŞDEĞER NO 1 Equivalent No 1	EŞDEĞER NO 2 Equivalent No 2	ÖLÇÜLER - MM. Dimensions - MM.					TİP Type	MALZEME Material
046171-V	VOITH TİP (MERCEDES AXOR-ACTROS)	RETARDER MİLİ Retarder Axle	H457300	-	-	-	55,00	70,00		7,00		L3B	FKM
046172-V	VOITH TİP (MERCEDES AXOR-ACTROS)	RETARDER MİLİ Retarder Axle	H457300	-	-	-	55,00	70,00		8,00	21,00	SPL3B	FKM
047887-V	VOITH R115 (MERCEDES TRAVEGO-ECONIC)	RETARDER MİLİ Retarder Axle	0209971347	-	12019242	-	60,00	80,00		7,50	21,00	SPL3B	FKM
047886-V	VOITH R115 (MERCEDES TRAVEGO-ECONIC)	RETARDER MİLİ Retarder Axle	0209971247	-	12019243	065.490	60,00	80,00		7,50		L3B	FKM
412322-V	VOITH RETAEDER (MERCEDES 304-403)	RETARDER MİLİ Retarder Axle	0089978447	-	01033427	NA5269	115,00	140,00		10,00		L3B	FKM
4TM-104	VOITH R115 (MERCEDES TRAVEGO-ECONIC)	RETARDER KEÇE TM.TK. Retarder Sys.Seal Rep. Kit	-	-	-	-	-	-		-	-	TM	
4TM-103	(046171-V+046172-V) (MERCEDES AXOR-ACTROS)	RETARDER KEÇE TM.TK. Retarder Sys.Seal Rep. Kit	H457300	-	-	-						TM	
4TM-107	(4TM-103 + PTFE RING) (MERCEDES AXOR-ACTROS)	RETARDER KEÇE TM.TK. Retarder Sys.Seal Rep. Kit	H457300	-	-	-						TM	
4TM-108	(4TM-107 + O-RING VE DİĞER SIZ.MALZ.) (MERCEDES AXOR-ACTROS)	RETARDER SIZD. TM.TK. Retarder Seal Kit	H457300	-	-	-						TM	

RETARDER / Retarder

SKT NO	KULLANILAN MODELLER Models	KULLANIM YERİ Place Of Use	ORJİNAL NO 1 Original No 1	ORJİNAL NO 2 Original No 2	EŞDEĞER NO 1 Equivalent No 1	EŞDEĞER NO 2 Equivalent No 2	ÖLÇÜLER - MM. Dimensions - MM.					TİP Type	MALZEME Material
412386-V	TELMA RET. (FORD KARGO 1838-2538-3238 İÇİN)	RETARDER MİLİ Retarder Axle	BC462D292AA	-	-	-	90,00	130,00		9,50	16,00	SC10	FKM

ŞANZIMAN / Gearbox

SKT NO	KULLANILAN MODELLER Models	KULLANIM YERİ Place Of Use	ORJİNAL NO 1 Original No 1	ORJİNAL NO 2 Original No 2	EŞDEĞER NO 1 Equivalent No 1	EŞDEĞER NO 2 Equivalent No 2	ÖLÇÜLER - MM. Dimensions - MM.					TİP Type	MALZEME Material
412289-V	EATON 23000 SERİ DİFR.	MAHRUTİ (DİFER.ÖN) Differential - Front	210724	-	01020451	-	74,60	128,00	143,00	12,50	27,50	SPL1LR SS-RL	FKM
045830-P	EATON 5 VİT. ŞANZ.	ŞANZIMAN ÖN Gearbox Front	4300798	-	-	-	41,28	63,65		7,93		L1L SAĞ -Right	ACM
045827-V	EATON 4206-6209-8209 MOD.	ŞANZIMAN ÖN Gearbox Front	X8870760	-	20016209	586.676	48,00	65,00		10,00		L13TL SAĞ -Right	FKM
047554-P	EATON ŞANZ.	ŞANZIMAN ARKA Gearbox Rear	X13072	-	-	-	53,98	76,40		9,52		L3L SOL-Left	ACM
047647-V	EATON 4106	ŞANZIMAN ARKA Gearbox Rear	X13711	-	12014424	-	65,00	85,00		13,00	9,50	L3L SOL-Left	FKM
047648-P	EATON ŞANZ.	ŞANZIMAN ARKA Gearbox Rear	4300119	-	12014289	-	70,00	90,00		12,00		L1L SS-RL	ACM
047645-V	EATON ŞANZ.	ŞANZIMAN ARKA Gearbox Rear	X8872722	-	12013860	034.347	78,00	100,00		10,00		L13TL SOL -Left	FKM
410341-V	EATON 8209	ŞANZIMAN ARKA Gearbox Rear	X8875615	-	12012579	702.994	90,00	110,00		12,00		L13TL SOL -Left	FKM
4FM-112-CA	EATON 8209 ŞANZ.	ŞANZIMAN YAĞ BORUSU Gearbox Oil Pipe	X8875532	-	-	-	65,00	70,00		2,10		L KARE	PTFE

AKS - ŞANZIMAN - DİFERANSİYEL / Axle - Gearbox - Differential

SKT NO	KULLANILAN MODELLER Models	KULLANIM YERİ Place Of Use	ORJİNAL NO 1 Original No 1	ORJİNAL NO 2 Original No 2	EŞDEĞER NO 1 Equivalent No 1	EŞDEĞER NO 2 Equivalent No 2	ÖLÇÜLER - MM. Dimensions - MM.					TİP Type	MALZEME Material
417130-VN	DİFR. (CARGO 3230-YENİ MODELLER İÇİN)	ARKA AKS İÇ Rear Axle Inner	AC461175AA	001251544	12014852	-	155,00	190,00		14,50	16,00	SC6	FKM+NBR
417124-V	DİFR. (CARGO 3230-YENİ MODELLER İÇİN)	ARKA AKS İÇ Rear Axle Inner	AC461175AA	123601601	12014852	-	155,00	190,00		14,50	16,00	SC6	FKM
410364-V	DANA M230-T DİFR.	MAHRUTİ (DİFER.ÖN) Differential - Front	070HH139-1	93193136	12013643	UH0327E	76,20	114,43	120,65	10,90	19,05	SPL1LLR SS-RL	FKM
410265-V	-	MAHRUTİ (DİFER.ÖN) Differential - Front	001132804	-	12002888	12011412	90,00	110,00		13,00		SLL	FKM
047544	-	ŞANZIMAN ÖN Gearbox Front	1020027	001020027	01032873	-	75,00	100,00		10,00		L3L	NBR

DANA

AKS - ŞANZIMAN - DİFERANSİYEL / Axle - Gearbox - Differential

SKT NO	KULLANILAN MODELLER Models	KULLANIM YERİ Place Of Use	ORJİNAL NO 1 Original No 1	ORJİNAL NO 1 Original No 2	EŞDEĞER NO 1 Equivalent No 1	EŞDEĞER NO 1 Equivalent No 2	ÖLÇÜLER - MM. Dimensions - MM.					TİP Type	MALZEME Material
045636	-	ŞANZIMAN ARKA Gearbox Rear	001010569	-	12011333	041.335	55,00	75,00		10,00		L1	NBR
045768-P	-	PTO MİLİ Power Take Off Shaft	000051170	214005	12010967	-	50,00	68,00		8,00		L3TL	ACM

ROCKWELL

DİFERANSİYEL / Differential

SKT NO	KULLANILAN MODELLER Models	KULLANIM YERİ Place Of Use	ORJİNAL NO 1 Original No 1	ORJİNAL NO 1 Original No 2	EŞDEĞER NO 1 Equivalent No 1	EŞDEĞER NO 1 Equivalent No 2	ÖLÇÜLER - MM. Dimensions - MM.					TİP Type	MALZEME Material
410364-V	ROCKWELL DİFERANSİYEL	MAHRUTİ (DİFER.ÖN) Differential - Front	A1205Y1949	-	12013643	-	76,20	114,43	120,65	10,90	19,05	SPL1LLR SS-RL	FKM
415161-VN	ROCKWELL DİFERANSİYEL	MAHRUTİ (DİFER.ÖN) Differential - Front	A1205U1945	42531764	12006484	457.270	82,61	139,70		16,50	19,40	SPL3LL4 SS-RL	FKM+NBR
412352-VP	ROCKWELL DİFERANSİYEL	MAHRUTİ (DİFER.ÖN) Differential - Front	9P920308	-	-	-	82,00	140,00	149,00	18,00	21,50	SC	FKM+ACM

FULLER

ŞANZIMAN - DİFERANSİYEL / Gearbox - Differential

SKT NO	KULLANILAN MODELLER Models	KULLANIM YERİ Place Of Use	ORJİNAL NO 1 Original No 1	ORJİNAL NO 1 Original No 2	EŞDEĞER NO 1 Equivalent No 1	EŞDEĞER NO 1 Equivalent No 2	ÖLÇÜLER - MM. Dimensions - MM.					TİP Type	MALZEME Material
410368-V	FULLER RTOX-R340 T1	ŞANZIMAN ARKA Gearbox Rear	21036	F19109	12012235	967.850	95,30	114,29		11,88		L13TL SS-RL	FKM
040713	FULLER ŞANZ.	ŞANZ. DEBRİYAJ KEÇESİ Clutch Shaft Seal	0229972847	-	12002188	120.103	22,00	35,00		7,00		L3L	NBR

MERITOR

DİFERANSİYEL / Differential

SKT NO	KULLANILAN MODELLER Models	KULLANIM YERİ Place Of Use	ORJİNAL NO 1 Original No 1	ORJİNAL NO 1 Original No 2	EŞDEĞER NO 1 Equivalent No 1	EŞDEĞER NO 1 Equivalent No 2	ÖLÇÜLER - MM. Dimensions - MM.					TİP Type	MALZEME Material
410498 - V	MERITOR DİFERANSİYEL	MAHRUTİ (DİFER.ÖN) Differential - Front	1524838	-	49364255	-	68,00	102,00		9,50	14,50	SPL3TLR SOL	FKM

A series of horizontal dotted lines for writing, spanning the width of the page.





SKT Yedek Parça ve Makina Sanayi ve Ticaret A.Ş.
BOSB, Ali Osman Sönmez Bulvarı No: 17 16140 Nilüfer/Bursa-TÜRKİYE
T:+9 0 224 243 41 00 info@skt.com.tr



TecAlliance
Certified Data Supplier