



OTOMOBİL & HAFİF TİCARİ ARAÇ KATALOĞU
Passenger Car & Light Commercial Vehicle Catalogue

2022

Sektöründe,
müşteri ilişkilerini güven ve
memnuniyet temeli üzerine kurmuş olan SKT,
sızdırmazlık ürünleri konusunda doğru ve güvenilir çözümler
sunmaya devam etmektedir.

Yenilikçi ve mükemmeliyetçi gelecek vizyonu ile sektöründe zirvenin en güçlü
oyuncularından biri olmayı başaran SKT, ürün gamına kattığı ürün çeşitleri iş ortaklarına her
zamanki gibi üstün kalitede ürünler sunmayı amaçlamıştır.

SKT'nin ürün bilgilerine **TECDOC** katalog sisteminden ulaşabilirsiniz.

SKT, 2022 yılında da müşterilerine üstün kaliteye sahip ürünlerini, müşteri memnuniyeti odaklı hizmet, hızlı ve
güvenilir teslimat prensibiyle sunarak yoluna emin adımlarla devam edecektir.

65 yıldır ailemizin bir parçası olan tüm değerli iş ortaklarımıza teşekkür ederiz.

Having established its customer relations based on trust and satisfaction, SKT
continues to offer proper and reliable solutions for sealing products.

With its innovative and perfectionist vision of the future, SKT has managed to become one of the strongest
players in the sector and aims to offer its business partners high-quality products.

SKT is a certified data supplier of TecAlliance.
SKT's product portfolio is available at **TecDoc**.

SKT will continue on its way with firm steps by offering its customers high-quality
products also in 2022 with the principle of customer-oriented services and fast and
reliable deliveries.

We would like to thank all our valuable business partners who have been
a part of our family for 65 years.

OTOMOBİL & HAFİF TİCARİ ARAÇ
KATALOĞU

Passenger Car & Light Commercial Vehicle Catalogue

www.skt.com.tr

BİZİ TAKİP EDİN / Follow us



•sktoilseals



•sktanonimsirketi



•skt a.ş.



•skt yağ keçeleri

**Bu katalog önceki tüm sayıların yerini almaktadır. Bu katalog telif hakları ile korunmaktadır.
Bu kataloğun tamamının veya herhangi bir bölümünün çoğaltılması yasaktır.**

Bu katalogdaki motor veya araç üreticilerinin tüm orijinal parça numaraları sadece karşılaştırma amacıyla verilmiştir ve araç sahipleri ile temaslarda kullanılmamalıdır. Bu katalogdaki bilgilerin basım anında doğru olması için her türlü çaba gösterilmiştir, ancak SKT herhangi bir sorumluluk kabul edemez. Oluşabilecek hatalar için bileşenlerimizi gerektiği gibi değiştirme hakkımız saklıdır. Orijinal ekipman parça numaraları ve katalogda belirtilen eşdeğer numaralar, yalnızca SKT numaralarıyla çapraz referans karşılaştırması işlevi görür. Herhangi bir tavsiye notunda veya faturada görünmemelidirler.

This catalog replaces all previous editions. The catalog is protected by copyright.
Reproduction of this or any part of it is prohibited.

All original part numbers of engine or vehicle manufacturers in this catalog are provided for comparison purposes only and should not be used in contacts with vehicle owners. Every effort has been made to ensure that the information in this catalog is correct at the time of printing, but SKT cannot accept any liability. We reserve the right to change our components as necessary for any errors that may occur. Original equipment part numbers and equivalent numbers listed in the catalog serve only as a cross-reference comparison with SKT numbers. They should not appear on any referral notes or invoices.

Malzeme Bilgileri / Material Information

Tip Açıklamaları / Type Description Page

Tip Tanıtım Sayfaları / Type Description Page

Keçe Tiplerinde Kullanılan Harf Kodlarının Açıklamaları
Explanation Of Letter Codes Used In Seal Types

Keçe Ölçülendirme Sistemi
Seal Dimensioning System

Yağ Keçesi Genel Montaj Kuralları
Oil Seal Installation Guide

Otomobil & Hafif Ticari Araç Kataloğu
Passenger Car & Light Commercial Vehicle Catalogue

ALFA ROMEO

AUDI

BMC

BMW

CHEVROLET

CITROEN

DACIA

DAEWOO

DAIHATSU

FIAT

FORD

HONDA

HYUNDAI

6

7

8

10

11

12

16

20

23

26

28

29

37

40

41

42

52

66

67

IVECO

KARSAN

KIA

LADA

LANCIA

MAGIRUS / OTOKAR

MAZDA

MERCEDES

MINI

MITSUBISHI

NISSAN

OPEL

PEUGEOT

RENAULT

SEAT

SKODA

SUZUKI

TOYOTA

VOLKSWAGEN

VOLVO

72

74

75

78

80

84

87

91

97

98

102

105

112

121

129

132

136

138

141

145

İÇİNDEKİLER

MALZEME BİLGİLERİ / Material Information

Malzeme Adı Material	SKT Kodu SKT Code	Kısa Kodu Abbreviation	Çalışma Sıcaklığı Operating Temp.	AÇIKLAMA	DESCRIPTION
Nitril Kauçuk Nitrile Rubber	-N	NBR	-40 / 105	Genel olarak fiyat / fonksiyon dengesi yüzünden tercih edilen ve düşük sıcaklıklarda kullanılabilen yağ ve greslere dayanıklı genel amaçlı bir keçe malzemesidir. Glikol esaslı fren yağları ve EP katkılı yağlara direnci zayıftır. Yakıtlar ve sanayi sıvıları için özel geliştirilmiş karışımları vardır. Otomotiv sektöründe aks keçelerinde büyük bir kullanıma sahiptir.	It is an economical and general purpose sealing material and preferred due to being resistant against low temperature oil and grease. It has poor resistance to glycol based brake oils and oils with EP additives. There are specially developed mixtures of this material for fuels and industrial fluids. It has a great use in axle seals in the automotive industry.
Hidrojenenitril Kauçuk Hydrogenated Nitrile Rubber	-H	HNBR	-70 / 150	Genel olarak Nitril kauçuk özelliklerini taşır. Nitril kauçuğa ilave olarak esneklik, hava direnci ve ozona dayanım gibi yüksek mekanik özelliklere de sahiptir. Yüksek mekanik dayanım gerektiren direksiyon sistemi ve aks gibi yerlerde kullanım alanı vardır.	This rubber has similar characteristics to nitrile rubber, but it additionally has the mechanical features such as more flexibility, higher weather and ozone- resistance. It is used in applications where high mechanical strength is required such as steering systems, axles and so on.
Florokarbon Kauçuk Fluorocarbon Rubber	-V	FKM	-30 / 220	Sıcaklığın ve yüksek devirin olduğu ortamlarda kullanılan bir kauçuktur. Gres, yakıt, yağ, çözücüler ve kimyasal maddelerin bir çoğuna dayanıklıdır. Fiyat yönünden pahalı bir malzeme olmasına karşın otomotiv sektöründe motor, şanzıman, diferansiyel gibi alanlar ile endüstriyel alanda uzun süre dayanım istenen makinalarda tercih edilir.	This rubber is used in high temperature and high rpm conditions. It is resistant to many types of grease, fuel, oil, solvent and chemicals. Despite being relatively expensive- compared to the other types of rubber materials, this material is employed in fields such as engine, gearbox, differential in automotive industry and also in industrial machines when long-term durability is needed.
Poliakrilik Acrylic Rubber	-P	ACM	-30 / 150	EP katkılı yağlara ve ozona dayanıklı bir malzemedir. Yakıt ve düşük sıcaklık dayanımı zayıf bir malzemedir. Otomotiv sektöründe özellikle şanzıman ve diferansiyel keçelerinde yoğun olarak kullanılır.	This rubber has good resistance to oils with EP additives and ozone. Resistance to fuel and low temperature of this material is somewhat inferior. It is used in gearbox and differential seals in automotive sector.
Silikon Kauçuk Silicone Rubber	-S	VMQ	-60 / 225	Çok iyi bir motor keçesi malzemesidir. Esneklik, hava direnci ve ozona dayanımı yüksektir. Ancak haSS-RLas bir malzeme olduğu için kolayca yırtılabilir, deforme olabilir. Bu nedenle yüksek mekanik dayanım gerektiren ortamlarda ve yakıtlarda EP katkılı yağlarda kullanılması önerilmez.	This rubber is an excellent material for engine seals. In addition to flexibility, its weather and ozone resistance is very high. Yet, it is prone to wear-tear and deformation due to being a very sensitive material. Therefore, it is not recommended in conditions where oils with EP additives are used and high mechanical strength is required.
Etilen Propilen Kauçuk Ethylene-Propylene Rubber	-E	EPDM	-60 / 150	Glikol esaslı fren yağları, ozona, su buharına, fosfat ester akışkanlara direnci iyidir. Yakıtlarda ve petrol esaslı yağlara direnci düşüktür.	This rubber has good resistance to glycol based brake oils, ozone, water vapor, phosphate ester fluids whereas it has low resistance to fuels and petroleum based oils.
Stiren Butadien Kauçuk Styrene-Butadiene Rubber	-R	SBR	-50 / 100	Glikol esaslı fren yağları, asit ve bazlara alkole direnci iyidir. Genel olarak araçların fren sistemlerinde kullanılır. Yakıtlarda ve petrol esaslı yağlara direnci düşüktür.	This rubber has good resistance to glycol based brake oils, acids and bases. It is generally used in brake systems of vehicles. It has low resistance to fuels and petroleum based oils.
Tabii Kauçuk Natural Rubber	-T	NR	-60 / 90	Stiren Butadien kauçuk ile benzer özellikler gösterir. Araçların süspansiyon sistemleri gibi ozona direnç , yüksek esneklik ve mekanik dayanım gerektiren yerlerde kullanılır.	This rubber has similar features to styrene-butadiene rubber. It is used in areas like vehicle suspension systems where ozone resistance, high flexibility and high strength is required.
Politetrafloroetilen Polytetrafluoroethylene	-F	PTFE	-260 / 260	Bilinen tüm kimyasallara dayanıklı bir plastik malzemedir. Sürtünme katsayısı en düşük katı bir maddedir. Yapışma özelliği göstermeyen yağlamasız bir yatak malzemesidir. Uygulama alanına göre dolgu yapısı değiştirilebilir. Son yıllarda çok tercih edilen bir motor keçe malzemesidir.	This is a material which is resistant to all known chemicals. It has the lowest coefficient of friction of any solid material. It is a non-adhesive bearing material without lubrication. Filling composition of PTFE may change depending on the field of use. This material is highly preferred in engine seals recently.
Poliamid Polyamide	-C	PA	-20 / 90	Piyasa da "Naylon" olarak bilinir. Sürtünme ve aşınma gibi mekanik özellikleri iyidir. Yağlara, yakıtlara, esterlere, ketonlara karşı dirençlidir.	Also known as nylon, this material has high friction, wear resistance and good mechanical features. It is also resistant to oils, fuels, esters and ketones.
Termoplastik Poliüretan Thermoplastic Polyurethane	-L	TPU	-40 / 90	Özellikle esneklik, aşınma ve sürtünme gibi yüksek mekanik özelliklerine sahip bu malzeme yağlara, greslere ve birçok çözücüye göre dirençlidir. Kullanım yeri kirliliği ve aşındırıcıların yoğun olduğu ortamlarda kullanılan kombi keçelerin yağ dudaklarını koruyucu malzeme olarak kullanılır. Çit-gel harekete sahip ortamlarda da sızdırmazlık malzemesi olarak kullanılır.	In addition to good mechanical features such as high flexibility, high wear and friction durability, this rubber is resistant to oils, greases and many solvents. It is used as a protective material in sealing lips of combi seals which are employed in areas that contains highly dirty and abrasive particles. It is used as sealing material where back and forth axial movement is performed.
Etilen Akriklik Kauçuk Ethylene Acrylic Rubber	-AE	AEM	-30 / 150	Yüksek ısı ve ozon direncine sahip olan AEM kauçuk , motor yağları, şanzıman sıvıları, asidik kondensatlar, üre çözeltileri, soğutucu sıvılar ve gresler gibi sıvılara dayanır. Düşük sıcaklıkta esnekliği, yüksek çekme dayanımı özellikleri ile elektrikli ve hibrit araç bileşenleri dahil olmak üzere zorlu otomotiv uygulamalarında çalışan sızdırmazlık elemanları ve grometlerin üretiminde kullanılır.	AEM rubber which has high heat and ozone resistance, withstands fluids such as engine oils, transmiSS-RLion fluids, acidic condensates, urea solutions, coolants and greases. With its low temperature flexibility, high tensile strength properties, it is used in the manufacture of seals and grommets that work in demanding automotive applications, including electric and hybrid vehicle components.

TİP AÇIKLAMALARI / Type Descriptions

Profil Tipleri / Profile Type			AÇIKLAMA	DESCRIPTION
 L3	 L3L	 L3TL	Dış çapları kauçuk kaplıdır. Bazı tiplerinde montaj kolaylığı ve yuvadaki deformasyon kaynaklı sızdırmalara karşı dış çaplarında tırtıl vardır. Ayrıca bazı tiplerinde de kirliliği ortamlarda koruyuculuk sağlayan toz dudak ilave edilmiştir. Isıl genleşme katsayısı yüksek, parçalı, yüzey pürüzlülüğü yüksek ve eksenli kaçık yuvalarda da kullanılabilirler.	Outer surfaces are rubber coated. Some types also have grooves on the outer layer in order to ease installation process and to act against leakages caused by the deformities in the housing bore. Furthermore, some types have dust lip for preventing dirt ingestion. They can be used in spaces consisting of materials with high coefficient of expansion and in divided spaces with a centre offset.
 L1	 L1L		Dış çapları metal kaplıdır. Yuvalarına sıkı geçerler. Isıl genleşme katsayıları yüksek metal (alüminyum gibi) yuvalarda ve parçalı yuvalarda kullanılması önerilmez. Bazı tiplerinde kirliliği ortamlar için koruyuculuk sağlayan kullanılan toz dudak ilave edilmiştir.	Outer surfaces are metallic. These seals are in interference fitting contact with the housing. Use of these types are not recommended in spaces with high coefficient of expansion (e.g. aluminium) and in divided spaces with a centre offset. Some types also have the secondary dust lip to exclude contaminants.
 L13	 L13L	 L3TL	Genel olarak L3 ve L1 kombinasyonuna sahip keçe tipleridir. Dış çaptaki sac bölge merkezleme ve sıklığı sağlarken kauçuk bölge ise kauçuk bölüm ise yuvadaki sızdırmazlığı sağlar. Isıl genleşmelerden az etkilenen modern bir dış tasarım sahiptirler.	In general, these seal types are a combination of types L1 and L3. On the outer diameter, metallic surface helps in centering while rubber surface provides sealing in the housing. They have a modern design that is affected less by thermal expansion.
 SL	 SLL		L1 keçe tiplerinin tüm özelliklerini taşımalarının yanında büyük çaplarda montaj kolaylığı sağlarlar. Yapısal olarak montaj hatalarına karşı daha dirençlidirler. İç taraftaki bilezik keçeye büyük bir mukavemet sağlarken rulmanlardan gelen yağ jetlerini de karşılayarak keçe dudaklarının sağlıklı çalışmasını sağlarlar.	In addition to all features of type L1, these seals offer ease of assembly in large diameters. They are also quite resistant structurally against assembly errors. Inner ring enhances the structural strength of the seal, while also acts as a shield against oil jets to help sealing lip to function healthily.
 L3 B	 L3BL	 L3BTL	Standart yağ keçeleri 0,5 bar'a kadar çalışabilir. Bu tip keçeler daha yüksek basınçta çalışabilmesi için sac ve dudak profili özel tasarlanmıştır. Bu tip keçelerin verimli çalışabilmesi için ortam şartları, keçenin profili, dudak malzemesi, mil çapı ve devir sayısı önemlidir. Bu keçeler tasarıma da bağlı olmak üzere 5 bar'a kadar çalışabilirler.	Standard oil seals can operate at pressures up to 0,5 bar. Steel case and lip seal profiles of these seals, however, are designed specially in order to obtain the desired resistance against higher pressure values. In order these types of seals to run efficiently ambient conditions, design of the lip seal profile, lip material, shaft diameter and the rpm parameters are significant. Depending on the design, these seals can operate at pressures up to 5 bar.
 L2	 L5		Bu tip keçeler genel olarak gres ve yağ buharı ve tozlu ortamlar için kullanılır. Yay kullanılmadığı için sıvı sızdırmazlığına karşı kullanılmazlar. Bazı uygulamalarda mil kazıyıcı olarak da kullanılabilirler.	These types of seals are mainly used for sealing grease, lubricant steam and dust. Since there is no garter spring, they cannot be used for fluid sealing. In some applications, they can be employed as shaft wipers as well.
 SC4	 SC6		Birbirine bağlı olarak çalışan hareketli iki parçadan meydana gelirler. Dış taraf yuvaya, iç taraf ta mile sıkı geçerek çalışırlar ve sızdırmazlık mekanizması iki parça arasında garter yayına sahip sızdırmaz dudak ile kurulmuştur. Standart keçelere göre çok daha yüksek koruyuculuk sağlarlar. Genel olarak yüksek kirlilik ve yük altında çalışan traktör ve ağır vasıtaların akslarında kullanılırlar.	Cassette seals consist of two moving parts that operate in conjunction with each other. Outer ring is in interference fitting contact with the housing and the inner ring with the shaft, while the sealing mechanism is established with main lip with a garter spring in between these rings. Cassette seals are highly rigid and protective and therefore used for very heavy-duty and in dirty environments, like commercial vehicles, tractors and agricultural machinery.
 KOMBI 1	 KOMBI 2		Kombi keçeler yüksek koruyuculuğa ihtiyaç duyulan aşırı kirliliği ve aşındırıcı maddeler bulunan ortamlar için tasarlanmış keçe tipleridir. Genelde çift yaylı bir kauçuk sızdırmaz dudaklar ve aşınmaya dayanıklı plastik bir parça ile kombine çalışırlar. Özellikle aşırı kirliliği ortamlarda çalışan traktör aksları ve mekanik dayanım gerektiren direksiyon sistemlerinde kullanılırlar.	Combi seals are designed for extreme wear applications that require high resistance. Generally, two sealing lips with garter spring and an additional wear-resistant plastic part are operating together under the roof of one metal case. They are employed in tractor axles that work under extremely dirty conditions and in steering systems that require mechanical strength.
 F2TK	 F25TL	 F5F	Sürtünme katsayılarının düşük olması nedeniyle son yıllarda sıkça kullanılan motor keçesi tipleridir. Kullanıldığı motorlara düşük emisyon ve minimum güç kaybı avantajı sağlarlar. Standart keçelere göre dış çapları aynı özellikleri taşırlar ancak sızdırmaz dudaklar mile daha geniş bir noktada temas ederler ve mil kalitesi ve montaj yönünden daha hassas RLAs çalışan keçe tipleridir. Bazı tiplerinde toz dudak olarak non-woven malzeme kullanılır.	Due to low coefficient of friction they have, these seals are being used as engine seals more often in the recent years. The advantage of them are low emission and low power loss that they provide. Outer surfaces have the same features, however main sealing lips have bigger contact area in comparison to standard seals. Therefore shaft surface quality and installation accuracy plays a big role in sealing performance. Some types have a dust lip of non-woven material.
 ETS	 ETS	 ETS	Yeni nesil motorların daha verimli enerji kullanımı ve düşük emisyon değerleri beklenmektedir. Bu ETS tip keçeler düşük sürtünme, uzun ömür ve yüksek performans sağlayan yapısı sayesinde bu motorlarda rahatça kullanılabilir. Yaysız ve mile çok noktadan temas eden bir dudak yapısına sahiptirler. Yeni nesil düşük viskoziteli motor ve şanzıman yağları ile beraber yüksek performansta çalışırlar.	New generation engines are expected to offer more energy efficiency and low emission values. These ETS type seals are great fit for these engines since they provide features such as low friction, long service life and high performance. These seals are spring-less and in contact with the shaft at many points. They operate at high performance with new generation low viscosity engine and transmission oils.

TİP TANITIM SAYFALARI / Type Description Pages



L1

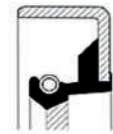

L1 SAĞ

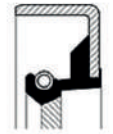

L1 SOL



L1B



L1CL SAĞ

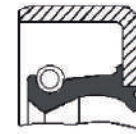

L1L



L1L SAĞ

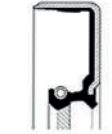

L1L SOL

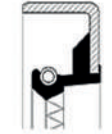

L1L SS



L1LR

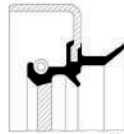

L1LR SAĞ



L2



L2BT



L2T



L2 TLL



L3



L3 SAĞ



L3 SOL



L3 SS



L3 B



L3BL

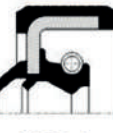

L3BLL



L3BT



L3BT SAĞ

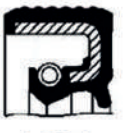

L3BTL



L3BTL SAĞ

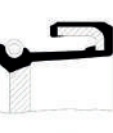

L3C



L3C SAĞ



L3L



L3L SAĞ



L3L SOL



L3L SS



L3LL SS

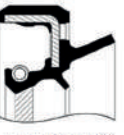

L3LR SAĞ

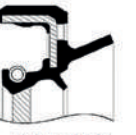

L3LR SOL



L3LR SS



L3T SAĞ

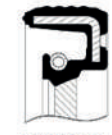

L3T SOL

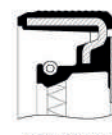

L3TF SS



L3TFR SAĞ



L3TL



L3TL SAĞ



L3TL SOL

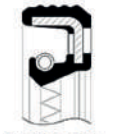

L3TL SS



L3TLL

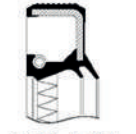

L3TLL SS



L3TLR



L3TLR SAĞ



L3TLR SS



LL3



LL3T SAĞ



LL3TL



L4 SAĞ



L5



L5L



L5LR



L5R

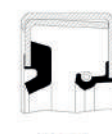

L5SL



L12BL SAĞ



L12L



L12L SAĞ



L12L SOL



L13



L13 SOL



L13L SAĞ

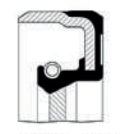

L13L SOL

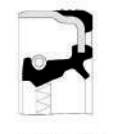

L13L SS

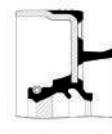

L13LL SAĞ

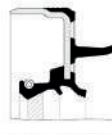

L13LR SAĞ



L13LR SOL

TİP TANITIM SAYFALARI / Type Description Pages



L13LR SS



L13TL



L13TL SAĞ



L13TL SOL



L13TL SS



L13TLL SS

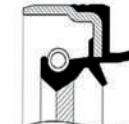

L13TLR SAĞ



L13TLR SOL



L13TLR SS



SL



SL3K



SLL



SLL SAĞ



SC6



SC9



SCL13TL SAĞ



F25TL SOL



F2TK SAĞ



F2TL SAĞ



F2TL SOL



ETS 10



ETS L13TL SAĞ

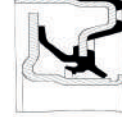

SC ETS1



L2 ETS SOL



L25TL ETS SOL



L2 TL ETS SAĞ



LSY

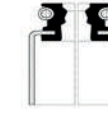

LSY1



LSY2T



LSY3T



LSY4T



LSY5T



LSY6



LSY6T



LSYT



LY1



LY3



T3



T3T

KEÇE DUDAK BÖLGESİNDEKİ TIRTILLARIN AÇIKLAMASI / Terminology For Sealing Aids

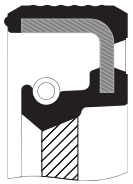

L3 SAĞ
L3 RIGHT

SAĞ DÖNÜŞLÜ MİLLER İÇİN
Right-Hand Twist



L3 SOL
L3 LEFT

SOLA DÖNÜŞLÜ MİLLER İÇİN
Left-Hand Twist



L3 SS
L3 RL

SAĞ VE SOLA DÖNÜŞLÜ MİLLER İÇİN
Alternate Twist

KEÇE TİPLERİNDE KULLANILAN HARF KODLARININ AÇIKLAMASI

Explanation Of Letter Codes Used In Seal Types

Sembol / Symbol	Açıklama	Örnek Kullanım / Exemplary Usage	Symbol	Description	Usage example
B	Basınca dayanıklıdır.	L3B	B	Pressure resistant.	L3B
C	Dudak keçe yüksekliğinden daha yüksektir. (1)	L3C	C	Lip height is higher than the seal height.	L3C
C	Keçe dıştan dudaklı ve çevreden çalışmaktadır. (2)	CL3	C	Seal with outside lip, works from periphery.	CL3
ETS	Düşük sürtünmeli (Yaysız) dudak yapısına sahiptir.	SC ETS	ETS	Seal without spring, low friction lip structure.	SC ETS
F	PTFE malzeme kullanılmıştır.	SP F	F	PTFE material is used.	SP F
K	Yün malzeme kullanılmıştır. (Non Woven-NW)	F2TK - NW	K	Wool material is used. (Non Woven-NW)	F2TK
L	Kauçuk malzeme kullanılmıştır.	L1, L3	L	Rubber material is used.	L1, L3
L	Toz dudaklıdır. (3)	L3L, L1L	L	With dust lip.	L3L, L1L
LL	Toz dudağı iki tanedir.	L3LL	LL	With two dust lips.	L3LL
R	Alından çalışan bir dudağa sahiptir.	L3R	R	With sealing lip on the front face.	L3R
T	Keçe dış yüzeyi tırtıllıdır.	L3TL	T	Outer surface grooved.	L3TL
SAĞ	Sağa dönen miller içindir.	L3L SAĞ - L3L RIGHT	RIGHT	For right-hand rotating shafts.	L3L RIGHT
SOL	Sola dönen miller içindir.	L3L SOL - L3L LEFT	LEFT	For left-hand rotating shafts.	L3L LEFT
SS	Her iki yöne de çalışan tırtıl yapısına sahiptir.	L3L SS - L3L RL	RL	For bi-directional shafts.	L3L - RL
SC	Kaset tipi keçedir.	SC1	SC	Cassette type seal.	SC1
SP	Standart tiplerden farklı olup, Özel tip tasarıma sahiptir. (Spesiyal) (4)	SPL3	SP	Special design, different from standard types.	SPL3
X	Çift yay ve çift yağ dudağa sahiptir.	L3X	X	With two lips and two springs.	L3X

(1) : Eğer tip tanımının sonunda ise

(2) : Eğer tip tanımının başında ise

(3) : Başa yazılırsa dudak içe doğru sona yazılırsa dudak dışa doğrudur.

(4) : Profil şekli konusunda dikkatli olunmalıdır.

Özel tasarıma sahip olan keçelerde detaylı bilgi için SKT'ye başvurulmalıdır.

(1) : If it is at the end of type definition

(2) : If it is at the beginning of type definition

(3) : Has an inward lip if it is at the beginning; has an outward lip if it is at the end.

(4) : Profile geometry is to be taken into account carefully.

For detailed information on shaft seals with special design, please consult SKT.

KEÇE ÖLÇÜLENDİRME SİSTEMİ / Seal Dimensioning System

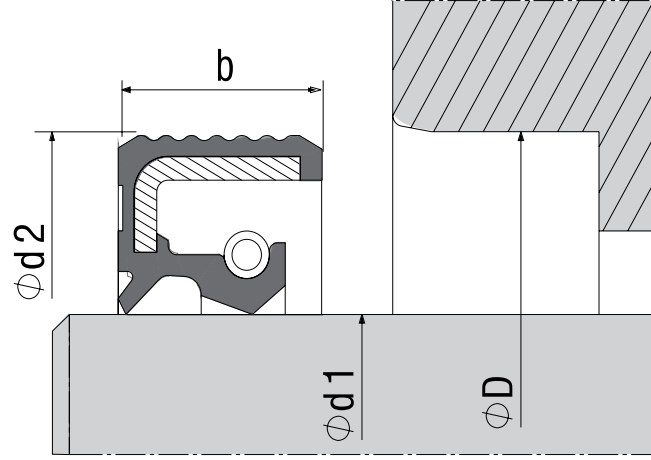

d1	Mil Çapı
D	Yuva Çapı
b	Keçe Yüksekliği
d2	Keçe Dış Çapı

d1	Shaft Diameter
D	Housing Diameter
b	Seal Height
d2	Seal Outer Diameter

Metrik Keçelerin Ölçülendirilmesi Dimensioning of metric seals	d1	x	D	x	b	İnç Ölçülü Keçelerin Ölçülendirilmesi Seal Dimensioning (inches)	d1	x	d2	x	b
	30	x	45	x	8		76,20	x	101,85	x	11,90
	Keçenin çalıştığı mil çapıdır. (Shaft diameter.)		Keçenin çalıştığı yuva çapıdır. (Housing diameter.)		Keçenin toplam yüksekliğidir. (Seal height.)		Keçenin çalıştığı mil çapıdır. (Shaft diameter.)		Keçenin dış çapıdır. Yuva çapı daha küçük olmalıdır. (Seal outer diameter. Housing diameter has to be smaller.)		Keçenin toplam yüksekliğidir. (Seal height.)

Metrik ölçülü keçelerde D ölçüsü, keçenin çalışacağı yuva çapıdır.
Keçe dış çapı bu yuvada yeterli sıklığı sağlayacak şekilde büyük üretilmiştir.

In metric system, dimension "D" is the housing bore diameter.
Seal outer diameter is specified accordingly to provide the required interference.

Inch ölçülü keçelerde, d2 ölçüsü keçenin dış çapıdır.
Yuva çapı, keçe dış çapından gerekli sıklığı sağlayacak kadar küçük olmalıdır.

In imperial system, dimension "d2" is the seal outer diameter.
Housing bore diameter has to be less than seal outer diameter to provide the required interference.

YAĞ KEÇESİ GENEL MONTAJ KURALLARI

A. KAÜÇUK DUDAKLI KEÇELER

1. Mil ve yuva; ölçüsel tolerans standartlarına uygun - hasarsız ve temiz olmalıdır.
2. Kauçuk malzemeli keçelerin dudakları montajdan önce ortam yağı ile yağlanmalıdır.
3. Keçe montajında uygun bir aparat kullanılmalıdır, kesinlikle çekiç kullanılmamalıdır.
4. Yay boyları kısaltılmamalıdır. Kısaltılırsa; aşırı sürtünmeden dolayı dudak ve mil hızlı bir şekilde aşınır.
5. Keçe dudağındaki sağ-sol helisel dönüş yönüne dikkat edilmelidir.
6. Kaset ve ABS tipli keçeler yapısal olarak çok hassas bir çalışma sistemine sahip olduğu için montaj sırasında keçenin metal kısmı üzerinde hasar bırakacak darbelerden kaçınılmalı ve aparat kullanılmalıdır.
7. Montajdan sonra keçenin salgısı kontrol edilmelidir.
8. Yuva çok bozuk değilse sıvı conta kesinlikle kullanılmamalıdır.

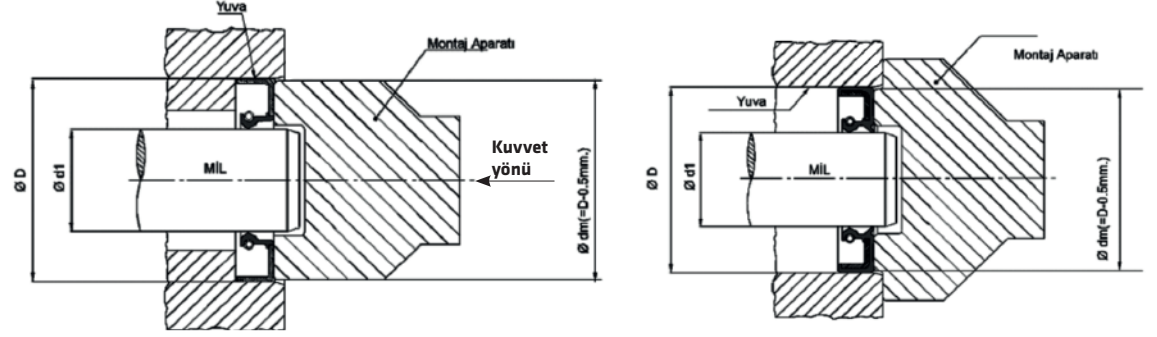

B. PTFE DUDAKLI KEÇELER

1. PTFE malzemeler mekanik olarak dayanımları zayıf olduğundan kesinlikle hasar görmemeli, mil yüzeyi uygun olmalıdır. PTFE dudağa kesinlikle el ile dokunulmamalı, metal bir madde değmemelidir.
2. Uygun bir aparat yardımı ile montaj yapılmalı çekiç kullanılmamalıdır.
3. PTFE keçeler, keçe üzerinde gelen plastik бага ile birlikte yuvaya yerleştirilmeli ve montaj işlemi bitince plastik бага yerinden çıkarılmalıdır.
4. PTFE malzemeli keçelerin dudakları kesinlikle yağlanmamalıdır. PTFE malzemesinin sürtünme katsayısı çok düşük olduğu için kuru çalışabilme özelliğine sahiptir. PTFE keçenin dudakları yağlanır ise ortamda bulunan her türlü aşındırıcıları mil ile dudak arasına toplayacağı için mekanik aşınmadan dolayı keçelerin ömrü kısa olur ve yağ kaçağı oluşabilir.
5. Montaj'dan sonra keçenin ölçüsel değerlerine ulaşabilmesi için motor, en az 4 saat sonra çalıştırılmalıdır. Eğer motor daha erken çalıştırılır ise keçe ölçüsel olarak gerçek boyutlarına ulaşılacağı için yağ kaçırrır.

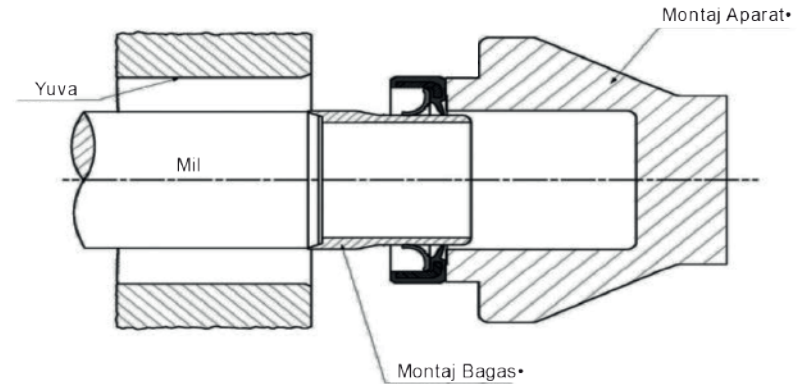

A. ELASTOMERIC LIP SEALS

1. Shaft and housing need to be clean, undamaged and dimensionally appropriate.
2. Elastomeric lip seals are to be lubricated with the ambient oil before installation.
3. A special installation tool is to be employed and never a hammer.
4. Garter springs are never to be shortened. (Shortened springs cause excessive tightness and eventually more wear of shaft and seal.)
5. Direction of the helical ribs on the sealing lip is to be taken into account.
6. When installing cassette and ABS type seals, hammering metal cases is to be avoided in order to prevent damaging blows, since those seals are very sensitive.
7. Seal runout is to be checked after the installation.
8. Gasket sealant is not to be used unless the housing is very defective.

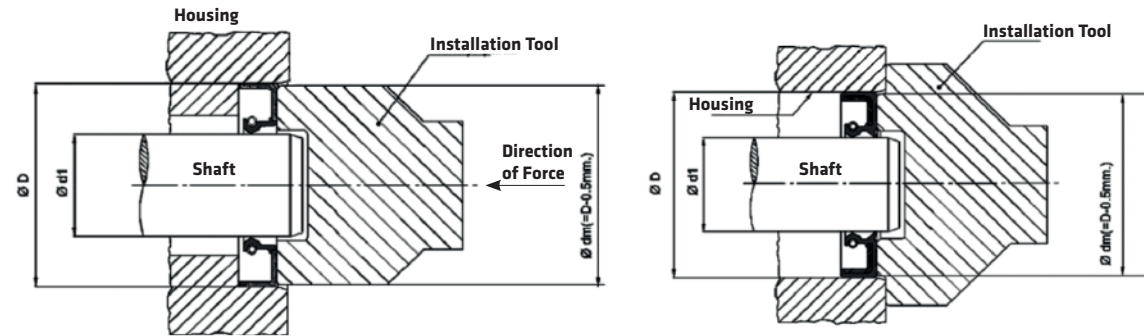

B. PTFE LIP SEALS

1. Due to being weak in terms of mechanical strength, PTFE lip seals are to be kept from any damages and shaft surface is to be superior. PTFE lip is never to be in contact with hand or metal object.
2. A special installation tool is to be employed and never a hammer.
3. PTFE lip seal installation is to be done with the plastic installation sleeve that comes with the product. Installation sleeve is to be removed after the installation.
4. PTFE lips are not to be lubricated. (PTFE material is suitable for dry running due to its very low coefficient of friction. In case of lubrication, majority of the ambient abrasives are drawn into the lubricant in between the lip and the shaft and this could potentially result in wear and eventually leakage.)
5. Do not start the engine sooner than 4 hours after installation. This permits the new sealing lip to adapt perfectly to the shaft.

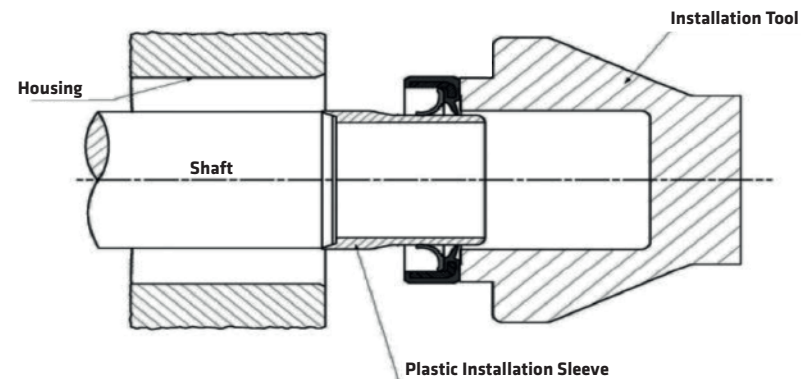

**SIZDIRMAZLIK
ELEMENLARINDA
67 YILLIK TECRÜBE**

**67 YEARS
OF EXPERIENCE
IN SEALING ELEMENTS**

**MARKA
MODEL**

Brand
Model

**MOTOR
GRUBU**

Engine
Group

**AKS
GRUBU**

Axle
Group

**DİĞER
ÜRÜNLER**

Other
Parts

**ŞANZİMAN
GRUBU**

Gearbox
Group

**DİREKSİYON
GRUBU**

Steering
Group

**DİFERANSİYEL
GRUBU**

Differential
Group

MOTOR GRUBU / Engine Group

SKT NO	KULLANILAN MODELLER Models	KULLANIM YERİ Place Of Use	ORJINAL NO 1 Original No 1	ORJINAL NO 2 Original No 2	EŞDEĞER NO 1 Equivalent No 1	EŞDEĞER NO 2 Equivalent No 2	ÖLÇÜLER MM. Dimensions - MM.				TİP Type	MALZEME Material
040675-P	75-90-155-164-GTV	KRANK ÖN Crank Shaft Front	40004250	-	12001470	440.720	30,00	43,00		8,00	L13TL SAĞ -Right	ACM
040944-V	75-90-145/146-ALFETTA-159-GT	KRANK ÖN Crank Shaft Front	60811207	55227599	12018321	069.590	31,00	41,00		7,00	L13TL SAĞ -Right	FKM
040634-S	75-90-GTV-SPIDER	KRANK ÖN Crank Shaft Front	60560702	-	12014674	507.725	35,00	50,00		10,00	L3L SAĞ -Right	VMQ
040831-V	33-75-90-164-SPIDER	KRANK ÖN Crank Shaft Front	60507107	60515781	12010669	507.725	35,00	50,00		10,00	L13TL SAĞ -Right	FKM
046132-P	33-145-147-155-GTV-SPIDER	KRANK ÖN Crank Shaft Front	60735515	-	12013896 12011459	040.355 040.363	42,00	62,00		10,00	L3TL SAĞ -Right	ACM
045827-V	75-90-155-164-GTV-SPIDER	KRANK ÖN Crank Shaft Front	60507285	60567607	12012045	586.676	48,00	65,00		10,00	L13TL SAĞ -Right	FKM
047601-P	164 2.0	KRANK ARKA Crank Shaft Rear	40004310	-	12001483	NA784	74,00	90,00		10,00	L13TL SOL -Left	ACM
047601-V	164 -166	KRANK ARKA Crank Shaft Rear	40004310	40002740	12001483 12001540	440.830	74,00	90,00		10,00	L13TL SOL -Left	FKM
417136-V	GIULIETTA-MITO 1.2-1.4 16V BENZİNLİ	KRANK ARKA Crank Shaft Rear	46539824	-	12018929	375.320	74,00	187,50	141,00	17,00	SPL1L 6SOL -Left	FKM
047838-FP	MITO 1.3 MJTD EURO 4/5/6	KRANK ARKA Crank Shaft Rear	55180937	93177284	20032405	428.970	78,00	100,00		9,00	F2TL SOL -Left	PTFE+ ACM
047645-V	MITO 1.3 MJTD EURO 4/5/6	KRANK ARKA Crank Shaft Rear	55180937	93177284	20032405	428.970	78,00	100,00		10,00	L13TL SOL -Left	FKM
410359-V	GT-33-159-164	KRANK ARKA Crank Shaft Rear	71739336	-	20033412	694.770	90,00	104,00		11,00	L3TL SOL -Left	FKM
410453-V	90-155	KRANK ARKA Crank Shaft Rear	7700859266	4403519	20018713	508.926	93,00	108,00		7,00	L3TL SOL -Left	FKM
415185-V	145-146-147-155-156-159-166 1.6-1.9-2.0-2.4 JTD-JTDM	KRANK ARKA Crank Shaft Rear	46435513 71713041	46435513 7750404	12015763	199.191	93,00	140,00	172,00	15,00	SPL1L SOL -Left	FKM
040789-V	145/146 (930) 1.9 JTD	EKSANTRİK MİLİ Cam Shaft	55196125	-	12019621	-	30,00	42,00		7,00	L3T SAĞ -Right	FKM
040880-P	145-146-156-159-166-SPIDER	EKSANTRİK MİLİ Cam Shaft	40004400	-	12011839 12019621	277.142 505.838	30,00	42,00		7,00	L3TL SAĞ -Right	ACM
040597-S	33-164	KRANK ÖN Crank Shaft Front	5957615	40004250	12001470	440.730	30,00	43,00		8,00	L1 SAĞ -Right	VMQ
041247-V	1.6-1.9-2.0 MJTD-JTDM-147-156-159-MITO- SPIDER	EKSANTRİK MİLİ Cam Shaft	46802577	-	12018345	434.500	30,00	45,00		7,00	L13TL SAĞ -Right	FKM

MOTOR GRUBU / Engine Group

SKT NO	KULLANILAN MODELLER Models	KULLANIM YERİ Place Of Use	ORJINAL NO 1 Original No 1	ORJINAL NO 1 Original No 2	EŞDEĞER NO 1 Equivalent No 1	EŞDEĞER NO 1 Equivalent No 2	ÖLÇÜLER MM. Dimensions - MM.				TİP Type	MALZEME Material	
045844-P	33-145/146-155-164 1.6 16V	EKSANTRİK MİLİ Cam Shaft	60801282	40004330	12012411	212.458 440.750	30,00	52,00		7,00	L13TL SAĞ -Right	ACM	
045819-P	147-155-164-AR6	EKSANTRİK MİLİ Cam Shaft	60801282	40004330	12012411	212.458 440.750	30,00	52,00		7,00	L13T SAĞ -Right	ACM	
046242-V	MITO 1.4 MOT.	EKSANTRİK MİLİ Cam Shaft	55189997	-	12019439	688.580	31,00	55,00		7,00	L13TL SAĞ -Right	FKM	
041303-V	75-159	EKSANTRİK MİLİ Cam Shaft	71739825	-	20031720	056.900 81-35147-00	31,50	42,00		7,00	L13TL SAĞ -Right	FKM	
040946-V	147-155-156-164-SPIDER	EKSANTRİK MİLİ Cam Shaft	60507402	60610985	12014699	325.155	32,00	47,00		10,00	L3TL SS-RL	FKM	
040815-V	159-147-155-156-164-GT-GTV	EKSANTRİK MİLİ Cam Shaft	55352607	-	20011244	353.990 81-24909-10	35,00	48,00		7,00	L13TL SAĞ -Right	FKM	
040815-V	159	EKSANTRİK MİLİ Cam Shaft	55352607	55563374	20011244	702.269	35,00	48,00		7,00	L13TL SAĞ -Right	FKM	
046217-V	159-MITO-SPIDER-GIULIETTA	EKSANTRİK MİLİ Cam Shaft	46434591	55195339	12016528 46085500	290.710	40,00	55,00		7,00	L13TL SAĞ -Right	FKM	
45-057-V	1.6-1.9-2.0 MJTD-JTDM-MULTIJET- 147-156-159-MITO-SPIDER	SUPAP Valve Stem Seal	55183812	-	19037053	-	5,00	10,00	23,40	15,40	LSY5T	FKM	
45-045-V	MITO 1.3 MJTD-1.4-1.6 16V EURO 4/5/6	SUPAP Valve Stem Seal	46556651	46470334	49472889	069.630 70-33512-00	6,00	8,80	11,70	9,50	LSY2T	FKM	
45-033-V	33-159-166	SUPAP Valve Stem Seal	60548495	289120381	12015802 49472012	701.289 70-26058-00	7,00	9,80	13,20	10,00	LSY2T	FKM	
45-021-V	145-147-159-33-155-156-166-GT-GTV	SUPAP Valve Stem Seal	60808696	60504110	12014584 49472013	294.110	8,00	10,80	14,20	10,00	LSY2T	FKM	
45-051-V	33-75-145-155-90-ALFETTA	SUPAP Valve Stem Seal	60535949	-	12015511	206.954 173.053	8,00	12,00	15,00	6,00	9,50	LSY2T	FKM
45-030-V	33-75-145-155-90-ALFETTA	SUPAP Valve Stem Seal	60535949	-	12015511	206.954 173.053	8,00	12,00	15,20	9,50	LSY2T	FKM	

AKS GRUBU / Axle Group

SKT NO	KULLANILAN MODELLER Models	KULLANIM YERİ Place Of Use	ORJINAL NO 1 Original No 1	ORJINAL NO 1 Original No 2	EŞDEĞER NO 1 Equivalent No 1	EŞDEĞER NO 1 Equivalent No 2	ÖLÇÜLER MM. Dimensions - MM.				TİP Type	MALZEME Material
045543	33-147-156-GT-GTV-SPIDER	ÖN AKS Front Axle	60501377	115104	12010981	-	55,00	70,00		8,00	L3	NBR

AKS GRUBU / Axle Group

SKT NO	KULLANILAN MODELLER Models	KULLANIM YERİ Place Of Use	ORJINAL NO 1 Original No 1	ORJINAL NO 2 Original No 2	EŞDEĞER NO 1 Equivalent No 1	EŞDEĞER NO 2 Equivalent No 2	ÖLÇÜLER MM. Dimensions - MM.					TİP Type	MALZEME Material
045822	147-156-159-166-GT	ÖN AKS Front Axle	60709430	101368	12011182	440.302	55,00	70,00		8,00		L3L	NBR
045945	GIULIA 1.3, 1.6	ARKA AKS Rear Axle	60751055	2340343640	12010887	-	30,00	52,00		10,00		L3TL	NBR
046006	33-145-155-156-164-GTV-SPIDER	ARKA AKS Rear Axle	60501947	60501550	12011154	045.772	40,00	52,00	58,00	8,50		SPL3TL	NBR

DİFERANSİYEL GRUBU / Differential Group

SKT NO	KULLANILAN MODELLER Models	KULLANIM YERİ Place Of Use	ORJINAL NO 1 Original No 1	ORJINAL NO 2 Original No 2	EŞDEĞER NO 1 Equivalent No 1	EŞDEĞER NO 2 Equivalent No 2	ÖLÇÜLER MM. Dimensions - MM.					TİP Type	MALZEME Material
041139-P	145-146-147-155-156-GT- MITO-SPIDER (916S) 3.0 V6 24V	DİFERANSİYEL SAĞ ÇIKIŞ Dif.-Right/Left Output	40004760	55227627	12014825	-	29,80	50,00		10,00	13,50	L13TLR SAĞ-Right	ACM
045884-V	33-156-159-166-MITO-SPIDER-	DİFERANSİYEL SAĞ ÇIKIŞ Dif.-Right/Left Output	71734264	71740625	01033292	-	35,00	54,90	61,00	9,00	14,70	SPL1L SS-RL	FKM
045899-P	33-145-147-155-156-GT	DİFERANSİYEL SAĞ ÇIKIŞ Dif.-Right/Left Output	40004630	-	12015266	12036825	36,00	54,00		10,00	13,50	L13TLR SAĞ-Right	ACM
047872-P	166 (936) 2.0 T.S. 16V	DİFERANSİYEL SAĞ ÇIKIŞ Dif.-Right/Left Output	9948922	-	20020137	504.581	40,00	58,00		11,30		SPL13TLL SS-RL	ACM
045226-V	33-75-147-155-156-164	DİFERANSİYEL ÖN-MAHRUTİ Differential Front-Bevelgear	60523920	127030	12001173	-	40,00	60,00		10,00		L3L	FKM
046121-P	75-90-145-146-147-155-156-ALFETTA	DİFERANSİYEL SOL ÇIKIŞ Differential Left Output	60809138	60806372	12014824	-	29,80	52,00		10,00	13,50	L13TLR SOL-Left	ACM
046123-VP	166 1.9-2.0-2.8 TD-JTD	DİFERANSİYEL SAĞ-SOL ÇIKIŞ Differential Right-Left Output	9948922	9403121440	20020137	504.581	40,00	58,00		10,00		L3TL SS- RL	FKM

ŞANZIMAN GRUBU / Gearbox Group

SKT NO	KULLANILAN MODELLER Models	KULLANIM YERİ Place Of Use	ORJINAL NO 1 Original No 1	ORJINAL NO 1 Original No 2	EŞDEĞER NO 1 Equivalent No 1	EŞDEĞER NO 1 Equivalent No 2	ÖLÇÜLER MM. Dimensions - MM.				TİP Type	MALZEME Material	
040818-P	MITO	ŞANZIMAN ÖN Gearbox Front	40004670	91111183	12014345	618RDAC	19,80	40,00		5,50	8,20	SPSL SAĞ -Right	ACM
041063-P	33-145-146-147-155-156-GT-SPIDER	ŞANZIMAN ÖN Gearbox Front	40004820	-	12014316	-	22,80	40,00		6,00	8,50	SLL SAĞ -Right	ACM
041292-P	159-MITO-SPIDER	ŞANZIMAN ÖN Gearbox Front	55565322	-	1036358	-	24,50	41,00		6,00		L13TL SAĞ -Right	ACM
041288-P	159-SPIDER 1.9 JTDM-2.2 JTS	ŞANZIMAN ÖN Gearbox Front	55180035	-	01033854	-	26,00	41,00		6,00		L13L SAĞ -Right	ACM
040322-P	33-164	ŞANZIMAN ÖN Gearbox Front	40000180	40002870	12011445	-	28,00	47,00		8,00		L1 SAĞ -Right	ACM
040817-P	MITO	VİTES SEÇİCİ MİLİ Gear Selection Shaft	40004800	40001700	12001623	610PAC	20,00	30,00		7,00		L13TL	ACM

MOTOR GRUBU / Engine Group

SKT NO	KULLANILAN MODELLER Models	KULLANIM YERİ Place Of Use	ORJINAL NO 1 Original No 1	ORJINAL NO 2 Original No 2	EŞDEĞER NO 1 Equivalent No 1	EŞDEĞER NO 2 Equivalent No 2	ÖLÇÜLER MM. Dimensions - MM.					TİP Type	MALZEME Material
040738-P	A3-A6-TT	KRANK ÖN Crank Shaft Front	2M311113	2M311113A	12016518	546.969	28,00	42,00		7,00		L3TL SAĞ -Right	ACM
040738-V	A3-A6-TT	KRANK ÖN Crank Shaft Front	2M311113	2M311113A	16012080	546.969	28,00	42,00		7,00		L3TL SAĞ -Right	FKM
040946-V	80-100-A3-A4-A6-Q5-Q7 1.3-1.6-1.9TDI	KRANK ÖN Crank Shaft Front	068103085E	026103085E	12012709	325.155 325.156	32,00	47,00		10,00		L3TL SS-RL	FKM
041272-FP	A3-A4-A5-A6-Q3-Q5-TT 1.9 TDI-1.8T-1.6-2.4-2.8 MOT.	KRANK ÖN Crank Shaft Front	038103085D	038103085A	20026413	129.780	32,00	47,00		10,00		F2TL SAĞ -Right	PTFE+ ACM
040969-V	80-90-100-A3-A4-A6 1.6-1.8T-2.0-1.9 TDI-TFSI	KRANK ÖN Crank Shaft Front	0544115147B	034115137A	12010739	294.357 475.961	35,00	48,00		10,00		L3TL SAĞ -Right	FKM
041273-FP	A1-A2-A3-A4-A5-A6-A8-Q3-Q5-TT 1.2TDI-1.4TDI-1.8T-2.0TDI	KRANK ÖN Crank Shaft Front	38103085	038103085B	20026412	155.560	35,00	48,00		10,00		F2TL SAĞ -Right	PTFE+ ACM
046217-V	A100	KRANK ÖN Crank Shaft Front	-	-	12016528 46085500	290.710	40,00	55,00		7,00		L13TL SAĞ -Right	FKM
410276-V	80-90-100 1.3-1.6-1.9-2.0 TDI	KRANK ARKA Crank Shaft Rear	056103051D	-	12012347	135.110 81-23708-50	85,00	105,00		12,00		L3TL SOL -Left	FKM
415242-FAEK	A3-A4-A6-TT 1.6-1.6İ-1.8-2.0 BENZİN MOT.	KRANK ARKA Crank Shaft Rear	06B103171B	06B103171E	20019557	012.380	85,00	131,00	152,00	15,70		SP F AL8	PTFE+ AEM+YÜN
410453-V	100	KRANK ARKA Crank Shaft Rear	-	-	20018713	508.926	93,00	108,00		7,00		L3TL SOL -Left	FKM
041310-FP	A1-A3-Q3 1.0-1.2-1.4 TFSI	EKSANTRİK MİLİ-ARKA Cam Shaft-Rear	04E 103 085	04E103085AC	20037127	242.620	24,00	39,00		8,00		F2TL SOL -Left	PTFE +ACM
041309-V	A2 1.4-1.6 MOT.	EKSANTRİK MİLİ Cam Shaft	036 103 085 H	036103085C	19036807	158.060	32,00	42,00		6,00	7,00	L13TL SAĞ -Right	FKM
041308-FP	A3-Q3 SERİSİ 1.0-1.2-1.4-1.5 TFSI-TSI	EKSANTRİK MİLİ Cam Shaft	04E 103 085 B	04E 103 085 AF	242.650	-	36,00	46,00		7,00		F2TL SAĞ -Right	PTFE +ACM
45-025-V	A1-A2-A3-A4-A5-A6 TSI-TFSI MOT.	SUPAP Valve Stem Seal	036109675A	036109675	12014670	12051545	6,00	8,80	12,20	6,00	10,00	LSY2T	FKM
45-033-V	A1-A2-A3-A4-A5-A6 TÜM MOT.	SUPAP Valve Stem Seal	027109675	-	12014671 12015802	701.289 70-26058-00	7,00	9,80	13,20	5,00	10,00	LSY2T	FKM
45-021-V	80-90-100-A4-A6 TÜM MOT.	SUPAP Valve Stem Seal	26109675	-	12014584 49472013	294.110	8,00	10,80	14,20	5,5	10,00	LSY2T	FKM

AKS GRUBU / Axle Group

SKT NO	KULLANILAN MODELLER Models	KULLANIM YERİ Place Of Use	ORJINAL NO 1 Original No 1	ORJINAL NO 1 Original No 2	EŞDEĞER NO 1 Equivalent No 1	EŞDEĞER NO 1 Equivalent No 2	ÖLÇÜLER MM. Dimensions - MM.					TİP Type	MALZEME Material
046006	80-90-100 1.3-1.6-1.9TDI	ARKA AKS Rear Axle	357501641B	321501641	12011153	045.772	40,00	52,00	58,00	6,00	7,5	SPL3TL	NBR

DİFERANSİYEL GRUBU / Differential Group

SKT NO	KULLANILAN MODELLER Models	KULLANIM YERİ Place Of Use	ORJINAL NO 1 Original No 1	ORJINAL NO 1 Original No 2	EŞDEĞER NO 1 Equivalent No 1	EŞDEĞER NO 1 Equivalent No 2	ÖLÇÜLER MM. Dimensions - MM.					TİP Type	MALZEME Material
045698-V	A1-A2-A3	DİFERANSİYEL SOL ÇIKIŞ Differential Left Output	02J409189A	-	07033882 12015555	-	48,00	62,00		8,00		L3L	FKM
046275-PL	A1-A3-TT SERİSİ	DİFERANSİYEL SAĞ ÇIKIŞ Dif.-Right/Left Output	02J409528A	02J409528C	01033861	228.490	48,00	60,00	74,00	12,60	26,60	SPL3L SAĞ -Right	ACM
046233-P	A1-A2-A3-Q3-TT	DİFERANSİYEL SAĞ ÇIKIŞ Dif.-Right/Left Output	02J409189A	02J409189E	12015555	228.480	48,00	62,00		8,00		L3TL SS-RL	ACM
046229-P	A1-A2-A3-Q3-TT 1.4 TSI-1.6-1.6FSI-1.9-2.0 TDI	DİFERANSİYEL SAĞ ÇIKIŞ Dif.-Right/Left Output	02T409189	02T409189C	01031878	454.260	50,00	65,00		8,00		L13L SS-RL	ACM
045867-P	A3- 1.8T-1.9 TDI	DİFERANSİYEL SAĞ ÇIKIŞ Dif.-Right/Left Output	02M409189	-	01033858	-	50,00	65,00		10,00		L3TLL SS-RL	ACM
046276-P	80-A3-A4-A6-COUPE	DİFERANSİYEL SAĞ ÇIKIŞ Dif.-Right/Left Output	020301189H	020301189N	12016928	527.858	50,00	65,20		10,00		L3TL SS-RL	ACM
046230-P	A1-A2-A3-Q2-Q3-TT 1.4TSI-1.4TDI-1.6 TDI-1.9-2.0 TDI	DİFERANSİYEL SAĞ ÇIKIŞ Dif.-Right/Left Output	02M301189	-	01029144	454.820	60,00	74,00		8,00		L13L SS-RL	ACM

ŞANZİMAN GRUBU / Gearbox Group

SKT NO	KULLANILAN MODELLER Models	KULLANIM YERİ Place Of Use	ORJINAL NO 1 Original No 1	ORJINAL NO 1 Original No 2	EŞDEĞER NO 1 Equivalent No 1	EŞDEĞER NO 1 Equivalent No 2	ÖLÇÜLER MM. Dimensions - MM.					TİP Type	MALZEME Material
041311-P	TT-A3-A1 1.4-TSI-1.6 TDI	ŞANZİMAN ÖN-AUTO. Gearbox Front-Automatic	0AM 301 733 K	0AM 301 733 H	01035820	908.420	20,50	28,00		7,00		L13L SS-RL	ACM
041315-P	A3 1.6	ŞANZİMAN ÖN Gearbox Front	020311113B	-	12016924	-	23,90	40,00		8,00			ACM
041275-P	A1-A2-A3	ŞANZİMAN ÖN Gearbox Front	02T311113A	-	01026708	870.310	24,00	38,00		6,00		L3T SAĞ -Right	ACM
046272-P	A4-A6-A8-A8-Q7 2.0-3.0-3.2 MOT.	ŞANZİMAN ÖN Gearbox Front	09E321243	-	01031573	519.540	45,00	58,00		7,00		L3TL SAĞ -Right	ACM

ŞANZİMAN GRUBU / Gearbox Group

SKT NO	KULLANILAN MODELLER Models	KULLANIM YERİ Place Of Use	ORJINAL NO 1 Original No 1	ORJINAL NO 2 Original No 2	EŞDEĞER NO 1 Equivalent No 1	EŞDEĞER NO 2 Equivalent No 2	ÖLÇÜLER MM. Dimensions - MM.				TİP Type	MALZEME Material	
041062-P	A1-A2-A3-TT	ŞANZİMAN ÖN Gearbox Front	085311113	-	12015554	191.320	21,8	35,00		7,00	L3TL SAĞ -Right	ACM	
041270-P	A3-A4	ŞANZİMAN ÖN Gearbox Front	20311113	-	12017266	244.040	21,9	40,00		8,00		ACM	
045821-P	A1-A2-A3-Q3-TT SERİSİ	ŞANZİMAN ARKA Gearbox Rear	02T409189C	02T409189C	01031878 12000767	454.260	50,00	65,00		8,00	L3L	ACM	
040644-P	80-90-100 SERİSİ	ŞANZİMAN MİLİ -OTOMATİK Gearbox Shaft - Automatic	087409085B	087409085A	01026310	-	28,00	40,00		7,00	L3TL SS -RL	ACM	
040748-V	A3	VİTES SEÇİCİ MİLİ Gear Selection Shaft	020311108A	020311109G	01020437	322.415	8,00	14,00		4,00	L13	FKM	
040690	OTOMOBİL	VİTES SEÇİCİ MİLİ Gear Selection Shaft	001301227C	-	12000444	-	15,00	24,00		7,00	L3L	NBR	
040838	A3	VİTES SEÇİCİ MİLİ Gear Selection Shaft	020301227F	020301227D	01019317	-	18,00	30,00		6,40	8,00	L3BTL	NBR

DİREKSİYON GRUBU / Steering Group

SKT NO	KULLANILAN MODELLER Models	KULLANIM YERİ Place Of Use	ORJINAL NO 1 Original No 1	ORJINAL NO 2 Original No 2	EŞDEĞER NO 1 Equivalent No 1	EŞDEĞER NO 2 Equivalent No 2	ÖLÇÜLER MM. Dimensions - MM.				TİP Type	MALZEME Material
041132-V	ZF TİP	DİREKSİYON POMPA Steering Pump	077008434	-	15020025	-	19,00	32,00		7,00	L3BTL	FKM
041204-H	A3 ZF TİP	DİREKSİYON KUTUSU Steering Box	7891033104	-	01019952	-	24,00	37,00		8,50	L3B	HNBR
041212-NL	ZF TİP	DİREKSİYON KUTUSU Steering Box	7891033104	-	01019952	-	24,00	37,00		8,50	L3BTI	NBR+TPU
041120	OTOMOBİL-ZF TİP	DİREKSİYON KUTUSU Steering Box	0770196082	0770196094	01019875	-	26,00	35,00		7,00	SPL3B	NBR
041121-H	80	DİREKSİYON KUTUSU Steering Box	-	-	01018101	-	26,00	37,00		7,00	L3BT	HNBR
041129-H	A4-A6	DİREKSİYON KUTUSU Steering Box	-	-	19019827	-	27,70	38,00		8,50	L3B	HNBR
040686	80-90	HİDROLİK DİREKSİYON KUTUSU Power Steering Box	32411123634	-	19020058	-	19,05	33,42		7,93	L12BL SAĞ -Right	NBR
040849	EM	DİREKSİYON SİSTEMİ Steering System	113415297	-	19015771	164.500	28,00	40,00		6,00	L3BTL	NBR

MOTOR GRUBU / Engine Group

SKT NO	KULLANILAN MODELLER Models	KULLANIM YERİ Place Of Use	ORJINAL NO 1 Original No 1	ORJINAL NO 1 Original No 2	EŞDEĞER NO 1 Equivalent No 1	EŞDEĞER NO 1 Equivalent No 2	ÖLÇÜLER MM. Dimensions - MM.					TİP Type	MALZEME Material
045529-S	TM-25 -TM-30 1.8 DI	KRANK ÖN Crank Shaft Front	2M10086	13H6516	15016600 12010683	-	39,69	59,08		9,52		L3L SAĞ -Right	VMQ
045529-V	TM25	EKSANTRİK MİLİ Cam Shaft	1311-6516	-	-	-	39,69	59,08	-	9,52	-	L3L SAĞ -Right	FKM
045892-V	LEVEND 1.8 TDI-PERKİNS MOT.	KRANK ÖN Crank Shaft Front	2M59087	-	-	-	48,00	58,00		7,00		L3L SAĞ -Right	FKM
047495-P	LEVEND 2.5-3.0 DI NISSAN MOT.	KRANK ÖN Crank Shaft Front	9P904402A	1351043G00	20034454	273.370	58,00	80,00		10,00		L3L SAĞ -Right	ACM
047663-S	LEVEND 2.5-3.0 DI NISSAN MOT.	KRANK ARKA Crank Shaft Rear	9P910550A	-	20029180	247.380	86,00	100,00		10,00		L3L SOL -Left	VMQ
410236-S	LEVEND 1.8-2.5-3.0 DI	KRANK ARKA Crank Shaft Rear	13H2457	-	-	-	88,90	105,05		9,52		L3 SOL -Left	VMQ
410236-V	LEVEND 1.8-2.5-3.0 DI	KRANK ARKA Crank Shaft Rear	2M201559	-	15510201	12017270	88,90	105,05		9,52		L3 SOL -Left	FKM
45-023-V	LEVEND 1.8 TDI	SUPAP Valve Stem Seal	57RS300936	-	-	-	7,94	12,30	16,00	4,50	8,60	LY1	FKM
45-008-V	TM-25 -TM-30-LEVEND 1.8 DI	SUPAP Valve Stem Seal	12B2104	-	-	-	8,73	14,32	16,66	6,73	11,10	L	FKM
040967-V	TM-25 -TM-30 1.8 DI	VAKUM POMPASI Vacuum Pump	-	-	-	-	9,45	15,80		4,10	6,30	L3C	FKM
040939-V	TM-25 -TM-30 1.8 DI	VAKUM POMPASI Vacuum Pump	-	-	-	-	17,00	32,00		7,00		L3BT SAĞ -Right	FKM

AKS GRUBU / Axle Group

SKT NO	KULLANILAN MODELLER Models	KULLANIM YERİ Place Of Use	ORJINAL NO 1 Original No 1	ORJINAL NO 1 Original No 2	EŞDEĞER NO 1 Equivalent No 1	EŞDEĞER NO 1 Equivalent No 2	ÖLÇÜLER MM. Dimensions - MM.					TİP Type	MALZEME Material
045582	LEVEND 2.5	ÖN AKS Front Axle	DMA4080	-	-	-	52,39	66,85		7,93		L3	NBR
045579	LEVEND 2.5-3.0 DI	ÖN AKS Front Axle	4M65590	-	-	-	55,00	75,00		10,00		L3	NBR
047575	LEVEND 1.8	ÖN AKS Front Axle	7M52283	373306	12010985	-	55,00	80,00		8,00		L3	NBR
0410055	MEGASTAR	ÖN AKS İÇ Front Axle Inner	57RS305356...	-	-	-	80,00	110,00		12,00		L3	NBR

AKS GRUBU / Axle Group

SKT NO	KULLANILAN MODELLER Models	KULLANIM YERİ Place Of Use	ORJINAL NO 1 Original No 1	ORJINAL NO 1 Original No 2	EŞDEĞER NO 1 Equivalent No 1	EŞDEĞER NO 1 Equivalent No 2	ÖLÇÜLER MM. Dimensions - MM.					TİP Type	MALZEME Material
045973	LEVEND 1.8-2.5-3.0 DI	ÖN AKS PİMİ Front Axle King Pin	57RS300984	-	-	-	50,00	58,00		4,00		L2	NBR
047501	MEGASTAR	ÖN AKS DIŞ Front Axle Outer	57RS305095	-	-	-	65,00	95,00		13,00		L3	NBR
045283	TM-25 -TM-30 1.8 DI	ARKA AKS Rear Axle	AAU7216	-	-	-	53,98	73,27		9,52		L3	NBR
047673	LEVEND 1.8-2.5-3.0 DI	ARKA AKS PORYA DIŞ Rear Axle Outer	4M54503	-	-	-	40,80	83,00		8,00	10,00	SPL2	NBR
0410149	MEGASTAR 5 TON	ARKA AKS PORYA DIŞ Rear Axle Outer	57RS305361	-	-	-	60,00	110,00		13,00		L3	NBR
047468	LEVEND 1.8-2.5-3.0 DI	ARKA AKS PORYA İÇ Rear Axle Inner	4M55681	-	-	-	60,00	85,00		10,00		L3L	NBR
0410332	MEGASTAR 5 TON	ARKA AKS PORYA İÇ Rear Axle Inner	57RS305356	38512262	-	-	80,00	110,00		12,00		L3L	NBR

DİFERANSİYEL GRUBU / Differential Group

SKT NO	KULLANILAN MODELLER Models	KULLANIM YERİ Place Of Use	ORJINAL NO 1 Original No 1	ORJINAL NO 1 Original No 2	EŞDEĞER NO 1 Equivalent No 1	EŞDEĞER NO 1 Equivalent No 2	ÖLÇÜLER MM. Dimensions - MM.					TİP Type	MALZEME Material
045307	TM-25 -TM-30 1.8 DI	DİFERANSİYEL ÖN-MAHRUTİ Differential Front-Bevelgear	ATC7085	-	-	-	38,10	69,95		9,52		L3	NBR
045639-V	LEVEND 2.5-3.0 DI	DİFERANSİYEL ÖN-MAHRUTİ Differential Front-Bevelgear	4M13861	-	01026326	-	42,00	75,00		11,50		SPL1L SAĞ-Right	FKM
047733-V	LEVEND 1.8 TDI	DİFERANSİYEL ÖN-MAHRUTİ Differential Front-Bevelgear	4M13861	-	-	-	42,00	75,00	99,50	12,00	19,50	SPL1LR SAĞ-Right	FKM
045658-P	LEVEND 1.8-2.5-3.0 DI	DİFERANSİYEL ÖN-MAHRUTİ Differential Front-Bevelgear	4M90421	-	-	-	50,00	75,00		10,00		L3L	ACM
045658-P	LEVEND 2.5-3.0 DI	DİFERANSİYEL ÖN-MAHRUTİ Differential Front-Bevelgear	4M65645	-	-	-	50,00	75,00		10,00		L3L	ACM
045658-V	LEVEND 1.8-2.5-3.0 DI	DİFERANSİYEL ÖN-MAHRUTİ Differential Front-Bevelgear	57RS301024	-	-	-	50,00	75,00		10,00		L3L	FKM
047383-V	MEGASTAR 5 TON	DİFERANSİYEL ÖN-MAHRUTİ Differential Front-Bevelgear	57RS304572	-	-	-	65,00	90,00		13,00		L3L SS-RL	FKM

ŞANZİMAN GRUBU / Gearbox Group

SKT NO	KULLANILAN MODELLER Models	KULLANIM YERİ Place Of Use	ORJINAL NO 1 Original No 1	ORJINAL NO 1 Original No 2	EŞDEĞER NO 1 Equivalent No 1	EŞDEĞER NO 1 Equivalent No 2	ÖLÇÜLER MM. Dimensions - MM.				TİP Type	MALZEME Material	
040695-P	LEVEND 1.8-2.5-3.0 DI	ŞANZİMAN ÖN Gearbox Front	UKC1060A	-	-	-	28,00	47,00		8,00		L3L SAĞ -Right	ACM
040467	TM-25 -TM-30 1.8 DI	ŞANZİMAN ÖN Gearbox Front	13H8395	-	-	-	28,58	47,80		9,52		L3 SAĞ -Right	NBR
045826	TM-30 5 VİTES ROVER ŞANZ.	ŞANZİMAN ÖN Gearbox Front	FRC6084	-	-	-	38,00	55,00		7,50	8,00	L3L SS- RL	NBR
046012	LEVEND 3.0 DI A115 TİP.	ŞANZİMAN ARKA Gearbox Rear	9P901796A	-	-	-	38,00	58,00		11,00	21,00	SPL3LR	NBR
047457	TM-25 -TM-30 1.8 DI	ŞANZİMAN ARKA Gearbox Rear	13H9213	-	-	-	39,69	76,27		9,92	14,28	L3L SOL -Left	NBR
045833-P	LEVEND 2.5 DI	ŞANZİMAN ARKA-OTOMATİK Gearbox Rear-Automatic	4423	-	UH0424F	-	47,62	70,02	80,17	13,00	14,80	SPL3LLR SS-RL	ACM
040479	TM-25 -TM-30 1.8 DI	ŞANZ. KLM ÇIKIŞ MİLİ Speedometer Shaft	12A1309	-	-	-	9,52	14,37		3,57		L5	NBR

DİREKSİYON GRUBU / Steering Group

SKT NO	KULLANILAN MODELLER Models	KULLANIM YERİ Place Of Use	ORJINAL NO 1 Original No 1	ORJINAL NO 1 Original No 2	EŞDEĞER NO 1 Equivalent No 1	EŞDEĞER NO 1 Equivalent No 2	ÖLÇÜLER MM. Dimensions - MM.				TİP Type	MALZEME Material	
040820	LEVEND 1.8-2.5-3.0 DI (ZF 8033)	DİREKSİYON KUTUSU Steering Box	0770198122	-	12016820	-	20,00	30,00		7,00	8,00	L3BTL	NBR
040645	TM-25 -TM-30 1.8 DI	DİREKSİYON KUTUSU Steering Box	D31294	5668489	-	-	22,22	35,12		6,35		L3BL	NBR
040694	LEVEND 1.8-2.5-3.0 DI	DİREKSİYON SEKTÖR MİLİ Steering Shaft	770198047	25146	12011143	251.402	35,00	47,00		7,00		L3BTL	NBR

FREN GRUBU / Brake Group

SKT NO	KULLANILAN MODELLER Models	KULLANIM YERİ Place Of Use	ORJINAL NO 1 Original No 1	ORJINAL NO 1 Original No 2	EŞDEĞER NO 1 Equivalent No 1	EŞDEĞER NO 1 Equivalent No 2	ÖLÇÜLER MM. Dimensions - MM.				TİP Type	MALZEME Material	
046004	LEVEND 1.8-2.5-3.0 DI	FREN ÖN KALİPER SİSTEMİ Brake Caliper System	57RS302323	-	-	-	46,00	56,00		4,00		L2	NBR
045894-P	LEVEND 3.0-80 P140 DI	FREN ÖN KALİPER SİSTEMİ Brake Caliper System	57RS301449	-	-	-	55,00	65,00		6,00		L2T	ACM
4TM-053	TM-25 -TM-30-2.5 DI	FREN HİD.MRKZ.SİLİNDİRİ Brake Hyd.Cylinder	T020058A	-	-	-						TM	-

MOTOR GRUBU / Engine Group

SKT NO	KULLANILAN MODELLER Models	KULLANIM YERİ Place Of Use	ORJINAL NO 1 Original No 1	ORJINAL NO 2 Original No 2	EŞDEĞER NO 1 Equivalent No 1	EŞDEĞER NO 2 Equivalent No 2	ÖLÇÜLER MM. Dimensions - MM.				TİP Type	MALZEME Material	
041282-V	7 SERİSİ E32	KRANK ÖN Crank Shaft Front	-	-	12025770	050.540	32,00	44,00		6,00		L3TL SAĞ -Right	FKM
041263-V	OTOMOBİL SERİSİ	KRANK ÖN Crank Shaft Front	11111485171	-	19036883	583.050	32,00	45,00		6,00		L3L SAĞ -Right	FKM
046026-V	3-5 SERİSİ - EM	KRANK ÖN Crank Shaft Front	-	-	12012248	914.924	45,00	67,00		8,00		L13T SAĞ -Right	FKM
046273-V	1-2-3-4-5-6-7-X SERİSİ N47 DİZEL MOT.	KRANK ÖN Crank Shaft Front	11117802665	-	19035978	584.160	55,00	68,00		8,00		L2TL ETS SAĞ-Right	FKM
046210-FP	1-3 SERİSİ	KRANK ÖN Crank Shaft Front	11117568264	-	19035976	004.450	61,00	75,00		8,00		F2TL SAĞ -Right	PTFE+ACM
047914-FP	1-2-3-4-5-6-7-X1-X2-X3-X4-X5-X6-Z- E81-E87-E90-E46-E91 =>2011	KRANK ÖN Crank Shaft Front	11117511395	7504867	20033890	257.400	65,00	79,00		20,00		SPF2TL SAĞ-Right	PTFE+ACM
046274-V	3-5-Z3 E30-E34-E36-E46 MOT.SERİSİ	KRANK ARKA Crank Shaft Rear	11141308342	11141721560	12014608	82014608	44,00	60,00		10,00		L13TL SAĞ-Right	FKM
047838-FP	3 SERİSİ E21-E30	KRANK ARKA Crank Shaft Rear	-	-	20032405	428.970	78,00	100,00		9,00		F2TL SOL -Left	PTFE+ACM
047645-V	3 SERİSİ E21-E30	KRANK ARKA Crank Shaft Rear	-	-	20032405	428.970	78,00	100,00		10,00		L13TL SOL -Left	FKM
410506-V	1-2-3-4-5-X1-X2-X4-X5- N47-N57 DİZEL MOT.	KRANK ARKA Crank Shaft Rear	11147797490	-	19036885	492.060	90,00	104,00		9,00		L25TL ETS SOL-Left	FKM
410505-V	1-2-3-4-5-6-7-X1-X3-X4-X6-Z4/ F20-F21-F80-E92-F34-F36-E84 2.0	KRANK ARKA Crank Shaft Rear	11117587168	-	20036307	751.610	90,00	110,00		8,00		L2 ETS SOL-Left	FKM
410507-FP	1-2-3-4-5-6-7- X1-X2-X3-X4-X5-X6-Z => 2011	KRANK ARKA Crank Shaft Rear	11117511396	11142247164	20019546 20033888	257.770	90,00	110,00		12,00		F25TL SOL-Left	PTFE+ACM
410453-V	3-5-6 SERİSİ E12-E24-E30	KRANK ARKA Crank Shaft Rear	-	-	20018713	508.926	93,00	108,00		7,00		L3TL SOL -Left	FKM
4S-074-V	BMW 1-2-3-4-5-6-7-X1-X2-X3-X4-X5- MINI SERİSİ DİZEL MOT.	SUPAP Valve Stem Seal	1134787347	-	49326062 49472881	539.420	5,00	10,00	21,50	16,00		LSY5T	FKM
4S-021-V	240 2.0 D, 2.4 D	SUPAP Valve Stem Seal	11341273501	-	12014584 49472013	294.110	8,00	10,80	14,20	10,00		LSY2T	FKM
4S-030-V	5 SERİSİ E39	SUPAP Valve Stem Seal	-	-	12015512	143.930 104.380	8,00	12,00	15,20	5,70	9,50	LSY2T	FKM
4S-051-V	5 SERİSİ E39	SUPAP Valve Stem Seal	-	-	12015512	143.930 104.380	8,00	12,00	15,00	6,00	9,50	LSY2T	FKM

DİFERANSİYEL GRUBU / Differential Group

SKT NO	KULLANILAN MODELLER Models	KULLANIM YERİ Place Of Use	ORJINAL NO 1 Original No 1	ORJINAL NO 1 Original No 2	EŞDEĞER NO 1 Equivalent No 1	EŞDEĞER NO 1 Equivalent No 2	ÖLÇÜLER MM. Dimensions - MM.					TİP Type	MALZEME Material
046268-P	BMW 1-3-4-5-6-7-X1-X3-X5-X6 E46-F20-F21-E53-70-X6 SERİSİ	DİFER. SAĞ-SOL ÇIKIŞ Dif.-Right/Left Output	33107505601	33411214142	01025620	82025620	44,00	67,00		10,00	15,50	L13LR SS- RL	ACM
047900-P	1-3-X3-Z4- E46-E81-E83-E85-E91 SERİSİ	DİFERANSİYEL SAĞ ÇIKIŞ Dif.-Right/Left Output	33107505603	-	01031731	-	44,00	78,10		10,00	15,50	SPL13LR SS-RL	ACM
047913-P	118D-120D- F20-F21-E87-90-92-93 DİZEL	DİFER. SAĞ-SOL ÇIKIŞ Dif.-Right/Left Output	33107505604	33137513974	01033294	15-31193-01	44,00	90,10		10,00	15,50	L13LR SS- RL	ACM

ŞANZİMAN GRUBU / Gearbox Group

SKT NO	KULLANILAN MODELLER Models	KULLANIM YERİ Place Of Use	ORJINAL NO 1 Original No 1	ORJINAL NO 1 Original No 2	EŞDEĞER NO 1 Equivalent No 1	EŞDEĞER NO 1 Equivalent No 2	ÖLÇÜLER MM. Dimensions - MM.					TİP Type	MALZEME Material
041307-V	BMW 1-2-3-4-5-X1-Z3-Z4	ŞANZİMAN ÖN Gearbox Front	23121222972	23121228424	01025674	82025674	30,00	50,00		7,00		L13T SAĞ -Right	FKM
046213-V	3-5-6-7-Z1 3.0-4.0 MOTOR 90 MODEL ŞANZİMAN	ŞANZİMAN ÖN Gearbox Front	23121209311	23121220619	01019289	-	35,00	52,00		7,00		L13TL SAĞ -Right	FKM
046272-P	BMW 1-3-5-6-7-X1-X5-X6-Z4-	ŞANZİMAN ÖN Gearbox Front	24317519352	-	01031573	519.540	45,00	58,00		7,00		L3TL SAĞ -Right	ACM
046271-P	F20-F21-F34-F31-F32 2011=>	ŞANZİMAN ÖN Gearbox Front	24277604965	-	19037196	49386952	53,00	71,00		7,00		L3TL SAĞ -Right	ACM
046214-P	BMW 3.0-4.0 MOTOR 3-5-7-8-Z8 SERİLERİ	ŞANZİMAN ARKA Gearbox Rear	23121222769	-	01026401	-	52,00	68,00	8	13,00		L13TLR SOL -Left	ACM
040426	3-5-6-7-Z3-Z4 SERİSİ	VİTES SEÇİCİ MİLİ Gear Selection Shaft	23111204223	-	01019151	-	15,00	21,00		5,00	7,00	L1L	NBR

DİREKSİYON GRUBU / Steering Group

SKT NO	KULLANILAN MODELLER Models	KULLANIM YERİ Place Of Use	ORJINAL NO 1 Original No 1	ORJINAL NO 1 Original No 2	EŞDEĞER NO 1 Equivalent No 1	EŞDEĞER NO 1 Equivalent No 2	ÖLÇÜLER MM. Dimensions - MM.					TİP Type	MALZEME Material
040850	EM-OLD MODELS	DİREKSİYON SEKTÖR MİLİSteering Shaft	12012799	23121201279	01001681	023.408	30,00	42,00		6,00		L3BTL	NBR
041316-HL	EM-OLD MODELS	HİDROLİK DİREKSİYON Steering Box	7852033140	-	01031617	82031617	28,00	38,00		7,00		SPL3BL	HNBR+TPU

MOTOR GRUBU / Engine Group

SKT NO	KULLANILAN MODELLER Models	KULLANIM YERİ Place Of Use	ORJINAL NO 1 Original No 1	ORJINAL NO 1 Original No 2	EŞDEĞER NO 1 Equivalent No 1	EŞDEĞER NO 1 Equivalent No 2	ÖLÇÜLER MM. Dimensions - MM.					TİP Type	MALZEME Material
047681-V	AVEO 1.2-1.3D-1.4-CRUSE 1.6 LACETTI 1.4-1.6-KALOS 1.4	KRANK ARKA Crank Shaft Rear	614830	90352112	12013882 49464345	590.797	80,00	98,00		10,00		L13L SOL -Left	FKM
047910-FP	CRUISE 1.6	KRANK ARKA Crank Shaft Rear	5614844	55355235	20034129 20033979	434.550 81-38236-00	80,00	98,00		14,60		SP F	PTFE +ACM
410359-V	LACETTI 1.8	KRANK ARKA Crank Shaft Rear	614840	90325572	20033412	694.770	90,00	104,00		11,00		L3TL SOL -Left	FKM
040815-V	NUBIRA-REZZO-KALOS 1.4	EKSANTRİK MİLİ Cam Shaft	636841	-	20011244 12016300	702.269	35,00	48,00		7,00		L13TL SAĞ -Right	FKM
041287-V	CAPTIVA-CRUSE-LACETTI-NUBIRA-EPICA 2.0 D-2.0 CDI	EKSANTRİK MİLİ Cam Shaft	-	-	20015457 07022633	505.366	36,00	50,00		7,00		L3TL SAĞ -Right	FKM
045765-V	LACETTI 1.4-1.6	EKSANTRİK MİLİ Cam Shaft	94580413	-	15031987 15011250	757.497 344.400	42,00	56,00		7,00		LL3T SAĞ -Right	FKM
45-025-V	LACETTI 1.8	SUPAP Valve Stem Seal	642533	4506051	12014670 12051545	724.590 70-33512-00	6,00	8,80	12,20	6,00	10,00	LSY2T	FKM

DİREKSİYON GRUBU / Steering Group

SKT NO	KULLANILAN MODELLER Models	KULLANIM YERİ Place Of Use	ORJINAL NO 1 Original No 1	ORJINAL NO 1 Original No 2	EŞDEĞER NO 1 Equivalent No 1	EŞDEĞER NO 1 Equivalent No 2	ÖLÇÜLER MM. Dimensions - MM.					TİP Type	MALZEME Material
041321	LACETTI	HİDROLİK DİREKSİYON Steering Box	-	-	19018211	82018211	19,80	39,70		6,35		L3BTL	NBR

MOTOR GRUBU / Engine Group

SKT NO	KULLANILAN MODELLER Models	KULLANIM YERİ Place Of Use	ORJINAL NO 1 Original No 1	ORJINAL NO 2 Original No 2	EŞDEĞER NO 1 Equivalent No 1	EŞDEĞER NO 2 Equivalent No 2	ÖLÇÜLER MM. Dimensions - MM.				TİP Type	MALZEME Material	
046119-FP	BERLINGO-C1-C2-C3-C4-C5-XSARA-NEMO 1.4 HDI-1.5 HDI-1.6 HDI EURO 5	KRANK ÖN Crank Shaft Front	012742	012750	20029116	026.750	40,00	55,00		6,40		F2TL SAĞ -Right	PTFE+ACM
045968-V	BERLINGO-JUMPER-JUMPY-C5-XSARA-BX-C4-C25 1.9 D - DW8	KRANK ÖN Crank Shaft Front	032622	032612	20015456	508.233 040.363	42,00	62,00		7,00		L13TL SAĞ -Right	FKM
046080-V	C2-C3-C4-SAXO-XSARA-BERLINGO-NE-MO-C15 1.6 16V TU5JP4	KRANK ÖN Crank Shaft Front	051472	0514A3	20018081	505.740 81-31863-00	42,00	66,00		6,00		L3TL SAĞ -Right	FKM
046219-FP	JUMPER 3.0 MOT.	KRANK ÖN Crank Shaft Front	0514C9	-	20034876	353.780	50,00	70,00		11,00		SPFPT2K SAĞ-Right	PTFE+ACM
047835-FL	JUMPER 2.2 HDI	KRANK ÖN Crank Shaft Front	0514.C6	-	19036447	026.782	50,00	90,00		14,00		SPF SAĞ -Right	PTFE+TPU
046210-FP	BERLINGO-C3-C4-C5-DS3-DS4-DS5	KRANK ÖN Crank Shaft Front	0514C8	1614085980	19035976	004.450	61,00	75,00		8,00		F2TL SAĞ -Right	PTFE+ACM
417107-V	JUMPER 2.8 HDI	KRANK ÖN Crank Shaft Front	0514C1	0514A7	12016918	199.220	70,00	158,00	180,00	16,00		SPL1L SAĞ -Right	FKM
047838-FP	BX-NEMO 1.3 MJTD	KRANK ARKA Crank Shaft Rear	55180937	93177284	20032405	428.970	78,00	100,00		9,00		F2TL SOL -Left	PTFE+ACM
047645-V	BX-NEMO 1.3 MJTD EURO 4/5/6	KRANK ARKA Crank Shaft Rear	55180937	93177284	20032405	428.970	78,00	100,00		10,00		L13TL SOL -Left	FKM
410386-V	C3-C4-SAXO-XSARA	KRANK ARKA Crank Shaft Rear	51474	-	12015424 20018066	508.462 81-23708-50	85,00	105,00		8,00		L3TL SOL -Left	FKM
410443-FP	BERLINGO-C2-C3-C4-C5-C15-SAXO-XSARA-NEMO 1.4-1.5-1.6 HDI -EURO 5	KRANK ARKA Crank Shaft Rear	012743	0514A2	20029117 20034738	026.790	85,00	105,00		8,80		F2TL SOL -Left	PTFE+ACM
415251-FAE	C ELYSEE-C2-C3-C4-DS3-DS4 1.2 PURU-TECH -1.0 VTI MOT.	KRANK ARKA Crank Shaft Rear	1609009780	16111874480	20037036	707.350	85,00	154,00	160,00	9,50		ETS 10	PTFE+AEM
410382-V	BERLINGO-JUMPER-C4-C5-XSARA-JUMPY-1.9 D DW8	KRANK ARKA Crank Shaft Rear	012728	96143793	20015455	508.209	90,00	110,00		7,00		L3TL SOL -Left	FKM
410500-V	JUMPER 3,0 D	KRANK ARKA Crank Shaft Rear	0514E0	0514E3	12019863	353.090	90,00	120,00		12,50	13,00	SC ETS1	FKM
417108-V	JUMPER	KRANK ARKA Crank Shaft Rear	0514C2	0514A8	12016920	199.230	114,00	171,00	177,00	13,00		SPL1L SOL -Left	FKM
041265-FP	C2-C3- 1.4 16V	EKSANTRİK MİLİ Cam Shaft	80733	-	19036292	505.600	24,00	50,00		8,00		F2TL SAĞ -Right	PTFE+ACM
041151-FP	BERLINGO-JUMPER-C3-C4-C5-XSARA-C15-NEMO 1.4 HDI EURO 5	EKSANTRİK MİLİ Cam Shaft	23765	80730	20029115	026.740	27,00	47,00		7,00		F2TL SAĞ -Right	PTFE+ACM

MOTOR GRUBU / Engine Group

SKT NO	KULLANILAN MODELLER Models	KULLANIM YERİ Place Of Use	ORJINAL NO 1 Original No 1	ORJINAL NO 2 Original No 2	EŞDEĞER NO 1 Equivalent No 1	EŞDEĞER NO 2 Equivalent No 2	ÖLÇÜLER MM. Dimensions - MM.				TİP Type	MALZEME Material	
041256-V	BERLINGO-C4-C5-JUMPER-XSARA-JUMPY-XANTIA 2.0 HDI	EKSANTRİK MİLİ Cam Shaft	080728	-	20026123	153.740	27,00	47,00		7,00		L3TL SAĞ -Right	FKM
040747-V	BERLINGO-JUMPER-XSARA-C15-ZX-1.9 D DW8	EKSANTRİK MİLİ Cam Shaft	80714	-	20018100	757.292	35,00	50,00		7,00		L3TL SAĞ -Right	FKM
040740-V	BERLINGO-CX-JUMPER-XANTIA	EKSANTRİK MİLİ Cam Shaft	023614	93501138	19026017	-	35,00	50,00		8,00		L3TL SAĞ -Right	FKM
041287-V	BERLINGO-C3-C4-C5-JUMPER-JUMPY-NE-MO-XSARA-SAXO-ZX 1.4-2.0 D	EKSANTRİK MİLİ Cam Shaft	023621	91515138	20015457 07022633	505.366	36,00	50,00		7,00		L3TL SAĞ -Right	FKM
041293-FP	C2-C3-C4-NEMO-BERLINGO 1.4 16V MOT.	EKSANTRİK MİLİ Cam Shaft	080732	-	19036293	505.100	36,00	50,00		8,00		F2TL SAĞ -Right	PTFE+ACM
041250-V	BERLINGO-C2-C3-C4-C5-XSARA-SAXO-ZANTIA-1.6 16V-TU5JP4	EKSANTRİK MİLİ Cam Shaft	080724	-	20018317	135.140 81-34146-00	38,00	50,00		6,00		L3TL SAĞ -Right	FKM
046217-V	C3-C4-C5-JUMPY-XSARA	EKSANTRİK MİLİ Cam Shaft	032627	-	12016528 46085500	290.710	40,00	55,00		7,00		L13TL SAĞ -Right	FKM
045898-V	JUMPY 1.6	EKSANTRİK MİLİ Cam Shaft	051478	46425764	12015853	440.760	40,00	56,00		7,00		L13TL SAĞ -Right	FKM
045990-V	JUMPER	EKSANTRİK MİLİ Cam Shaft	080729	-	12014728	419.730	55,00	70,00		8,00		L13TL SAĞ -Right	FKM
45-065-V	BERLINGO-C1-C3-AIRCROCS EP6 MOT. 1.2 MOT.	SUPAP Valve Stem Seal	1623068580	1611289780	70-12155-00	582.530	5,00	9,00	24,20	14,00		LSY5T	FKM
45-048-V	C1-C2-C3-XSARA-BERLINGO 1.4 HDI-1.5 HDI-1.6 HDI EURO5	SUPAP Valve Stem Seal	095650	1145937	19035539	027.750	5,50	9,20	23,00	17,70		LSY5T	FKM
45-047-V	C3-C4-C5-XSARA-BERLINGO-JUMPY 1.6 HDI	SUPAP Valve Stem Seal	095651	-	19035752	262.650	5,50	9,50	18,10	14,00		LSYT	FKM
45-025-V	C3-C4-C5-XSARA-SAXO-XANTIA 1.6 16V-TU5JP4-BERLINGO-2.0 HDI	SUPAP Valve Stem Seal	095638	095640-095670	12014670	403.730 70-33512-00	6,00	8,80	12,20	6,00	10,00	LSY2T	FKM
45-068-V	BERLINGO-C4-C5-JUMPY-JUMPER-XSARA 2.0 HDI DW10 MOT.	SUPAP Valve Stem Seal	095648	-	12016913	136.940	6,00	10,00	19,60	21,50		LSY5T	FKM
45-061-V	JUMPER 2.3-3.0 JTD MOT.	SUPAP Valve Stem Seal	095161	-	12019782 49472021	718.210	6,00	10,00	22,00	19,00		LSY5T	FKM

MOTOR GRUBU / Engine Group

SKT NO	KULLANILAN MODELLER Models	KULLANIM YERİ Place Of Use	ORJINAL NO 1 Original No 1	ORJINAL NO 1 Original No 2	EŞDEĞER NO 1 Equivalent No 1	EŞDEĞER NO 1 Equivalent No 2	ÖLÇÜLER MM. Dimensions - MM.					TİP Type	MALZEME Material
45-033-V	SAXO-XSARA 1.4-1.6 16V- 1.5 D	SUPAP Valve Stem Seal	095628	96020124	12015802	701.289 70-26058-00	7,00	9,80	13,20	5,00	10,00	LSY2T	FKM
45-031-V	JUMPER 2.2 HDI EURO 5	SUPAP Valve Stem Seal	0956.59	1096253	19036760	1626571	7,00	12,00	24,15	13,80	18,60	LSY6T	FKM
45-021-V	BERLINGO-JUMPER-XSARA 1.9D DW8	SUPAP Valve Stem Seal	095622	095637	12014584 49472013	294.110	8,00	10,80	14,20	5,50	10,00	LSY2T	FKM
45-030-V	JUMPER 2.8 MOT.	SUPAP Valve Stem Seal	095644	-	12015512	761.389	8,00	12,00	15,20	5,70	9,50	LSY2T	FKM
45-051-V	JUMPER 2.8 MOT.	SUPAP Valve Stem Seal	095644	-	12015512	761.389	8,00	12,00	15,00	6,00	9,50	LSY2T	FKM
45-051-V	BOXER 2.8 HDI	SUPAP Valve Stem Seal	095644	-	12015512	761.389	8,00	12,00	15,00	6,00	9,50	LSY2T	FKM
45-046-V	C3-C4- 1.4 16V	SUPAP Valve Stem Seal	095652	-	49472886 12019283	505.470	5,5	10,53	21,60	11,00	15,50	LSY5T	FKM
046221-P	JUMPER III	VAKUM POMPASI Vacuum Pump	4570.18	-	-	-	65,00	70,00		9,00		SPCL	ACM
041274-P	C2-C3-C4-C5-BERLINGO- XSARA-JUMPY DV6 MOT.	ENJEKTÖR GÖVDE KEÇESİ Injector Body Seal	1982.A0	1609848280	734.960	-	18,00	29,00		6,00		L2T	ACM

MOTOR CONTA GRUBU/Engine Gasket Group

SKT NO	KULLANILAN MODELLER Models	KULLANIM YERİ Place Of Use	ORJINAL NO 1 Original No 1	ORJINAL NO 1 Original No 2	EŞDEĞER NO 1 Equivalent No 1	EŞDEĞER NO 1 Equivalent No 2	ÖLÇÜLER MM. Dimensions - MM.	TİP Type	MALZEME Material
4C-011-70	C3/C4/C5/BERLİNGO 1.6 HDI	SİLİNDİR KAPAK CONTASI Cylinder Head Gasket	0209.CE	-	-	414114P/ 569.802	1 çentik - 1,35mm		
4C-011-71	C3/C4/C5/BERLİNGO 1.6 HDI	SİLİNDİR KAPAK CONTASI Cylinder Head Gasket	0209.CA	-	61-36265-00	414112P/ 569.812	2 çentik - 1,25mm		
4C-011-72	C3/C4/C5/BERLİNGO 1.6 HDI	SİLİNDİR KAPAK CONTASI Cylinder Head Gasket	0209.CC	-	-	414113P/ 569.820	3 çentik - 1,30mm		
4C-015-72	1.6 HDI EURO5 MOTORLAR 1.6 HDI (EURO5)	SİLİNDİR KAPAK CONTASI Cylinder Head Gasket	0209. JH	-	61-37940-20	49409418	4 çentik - 1,35mm		
4C-011-73	C3/C4/C5/BERLİNGO 1.6 HDI	SİLİNDİR KAPAK CONTASI Cylinder Head Gasket	0209.CF	-	-	414115P/ 569.832	4 çentik - 1,40mm		
4C-015-70	1.6 HDI, EURO5 MOTORLAR 1.6 HDI (EURO5)	SİLİNDİR KAPAK CONTASI Cylinder Head Gasket	0209. JF	-	61-37940-00	49409416	5 çentik - 1,25mm		
4C-011-74	C3/C4/C5/BERLİNGO 1.6 HDI	SİLİNDİR KAPAK CONTASI Cylinder Head Gasket	0209.CG	-	-	414116P/ 569.842	5 çentik - 1,45mm		
4C-015-71	1.6 HDI, EURO5 MOTORLAR 1.6 HDI (EURO5)	SİLİNDİR KAPAK CONTASI Cylinder Head Gasket	0209. JG	-	61-37940-10	49409417	6 çentik - 1,30mm		
4C-015-73	1.6 HDI EURO5 MOTORLAR 1.6 HDI (EURO5)	SİLİNDİR KAPAK CONTASI Cylinder Head Gasket	0209. JJ	-	61-37940-30	49409419	7 çentik - 1,40mm		
4C-015-74	1.6 HDI, EURO5 MOTORLAR 1.6 HDI (EURO5)	SİLİNDİR KAPAK CONTASI Cylinder Head Gasket	0209. JK	-	61-37940-40	49409490	8 çentik - 1,45mm		

MOTOR CONTA GRUBU/Engine Gasket Group

SKT NO	KULLANILAN MODELLER Models	KULLANIM YERİ Place Of Use	ORJINAL NO 1 Original No 1	ORJINAL NO 2 Original No 2	EŞDEĞER NO 1 Equivalent No 1	EŞDEĞER NO 2 Equivalent No 2	ÖLÇÜLER MM. Dimensions - MM.	TİP Type	MALZEME Material
4C-014-70	JUMPER 2.2 HDI	SİLİNDİR KAPAK CONTASI Cylinder Head Gasket	0209.EH	-	61-37365-00	415592P/ 156.201	1 çentik - 1,10mm		
4C-009-70	JUMPY/BERLİNGO (7/1998=>) 1.9 D (DW8)	SİLİNDİR KAPAK CONTASI Cylinder Head Gasket	0209.X0	-	61-33720-00	415032P/ 130.642	1 çentik - 1,26mm		
4C-010-70	C1/C2/C3/XSARA 1.4 HDI	SİLİNDİR KAPAK CONTASI Cylinder Head Gasket	0209.AF	-	61-35430-20	414109P/ 100.420	1 çentik - 1,35mm		
4C-014-71	JUMPER 2.2 HDI	SİLİNDİR KAPAK CONTASI Cylinder Head Gasket	0209.ES	-	61-37365-10	415593P/ 156.211	2 çentik - 1,15mm		
4C-010-71	C1/C2/C3/XSARA 1.4 HDI	SİLİNDİR KAPAK CONTASI Cylinder Head Gasket	0209.AC	-	61-35430-00	414107P/ 100.400	2 çentik - 1,25mm		
4C-009-71	JUMPY/BERLİNGO (7/1998=>) 1.9 D (DW8)	SİLİNDİR KAPAK CONTASI Cylinder Head Gasket	0209.X1	-	61-33720-10	415033P/ 130.652	2 çentik - 1,30mm		
4C-014-72	JUMPER 2.2 HDI	SİLİNDİR KAPAK CONTASI Cylinder Head Gasket	0209.ET	-	61-37365-20	415594P/ 156.221	3 çentik - 1,20mm		
4C-010-72	C1/C2/C3/XSARA 1.4 HDI	SİLİNDİR KAPAK CONTASI Cylinder Head Gasket	0209.AE	-	61-35430-10	414108P/ 100.410	3 çentik - 1,30mm		
4C-009-72	JUMPY/BERLİNGO (7/1998=>) 1.9 D (DW8)	SİLİNDİR KAPAK CONTASI Cylinder Head Gasket	0209.X2	-	61-33720-20	415034P/ 130.662	3 çentik - 1,34mm		
4C-009-73	JUMPY/BERLİNGO (7/1998=>) 1.9 D (DW8)	SİLİNDİR KAPAK CONTASI Cylinder Head Gasket	0209.X3	-	61-33720-30	415035P/ 130.672	4 çentik - 1,38mm		
4C-010-73	C1/C2/C3/XSARA 1.4 HDI	SİLİNDİR KAPAK CONTASI Cylinder Head Gasket	0209.AG	-	61-35430-30	414110P/ 100.430	4 çentik - 1,40mm		
4C-009-74	JUMPY/BERLİNGO (7/1998=>) 1.9 D (DW8)	SİLİNDİR KAPAK CONTASI Cylinder Head Gasket	0209.X4	-	61-33720-40	415036P/ 130.682	5 çentik - 1,42mm		
4C-010-74	C1/C2/C3/XSARA 1.4 HDI	SİLİNDİR KAPAK CONTASI Cylinder Head Gasket	0209.AH	-	-	61-35430-40	414111P/ 100.440 5 çentik - 1,45mm		
4C-010-30	C1/C2/C3/XSARA 1.4 HDI	ÜST TAKIM CONTA Cylinder Head Gasket Set	-	-	-	-	Silindir kapak contasız		
4C-011-30	C3/C4/C5/BERLİNGO 1.6 HDI	ÜST TAKIM CONTA Cylinder Head Gasket Set	-	-	-	-	Silindir kapak contasız		
4C-009-10	JUMPY/BERLİNGO (7/1998=>) 1.9 D (DW8)	TAM TAKIM CONTA Full Set Gasket	0197.X6	-	-	-	Silindir kapak contasız		
4C-010-10	C1/C2/C3/XSARA 1.4 HDI	TAM TAKIM CONTA Full Set Gasket	-	-	-	-	Silindir kapak contasız		
4C-011-10	C3/C4/C5/BERLİNGO 1.6 HDI	TAM TAKIM CONTA Full Set Gasket	-	-	-	-	Silindir kapak contasız		

MOTOR CONTA GRUBU/Engine Gasket Group

SKT NO	KULLANILAN MODELLER Models	KULLANIM YERİ Place Of Use	ORJINAL NO 1 Original No 1	ORJINAL NO 1 Original No 2	EŞDEĞER NO 1 Equivalent No 1	EŞDEĞER NO 1 Equivalent No 2	ÖLÇÜLER MM. Dimensions - MM.				TİP Type	MALZEME Material
4C-014-10	JUMPER 2.2 HDI	TAM TAKIM CONTA Full Set Gasket	-	-	-	-	Silindir kapak contasız					
4C-015-10	1.5 HDI/1.6 HDI EURO5 MOTORLAR 1.5 HDI/1.6 HDI (EURO5)	TAM TAKIM CONTA Full Set Gasket	-	-	-	-	Silindir kapak contasız					

AKS GRUBU / Axle Group

SKT NO	KULLANILAN MODELLER Models	KULLANIM YERİ Place Of Use	ORJINAL NO 1 Original No 1	ORJINAL NO 1 Original No 2	EŞDEĞER NO 1 Equivalent No 1	EŞDEĞER NO 1 Equivalent No 2	ÖLÇÜLER MM. Dimensions - MM.				TİP Type	MALZEME Material	
047739	JUMPER-C25	ÖN AKS İÇ-DIŞ Front Axle Inner-Outer	334621	334617	12015943	-	70,00	90,00		13,50		L1L	NBR
045991	JUMPER	ARKA AKS Rear Axle	372432	372443	12014086	-	58,00	75,00		14,00	15,50	L13TL	NBR

DİFERANSİYEL GRUBU / Differential Group

SKT NO	KULLANILAN MODELLER Models	KULLANIM YERİ Place Of Use	ORJINAL NO 1 Original No 1	ORJINAL NO 1 Original No 2	EŞDEĞER NO 1 Equivalent No 1	EŞDEĞER NO 1 Equivalent No 2	ÖLÇÜLER MM. Dimensions - MM.				TİP Type	MALZEME Material	
046234-V	C-ELYSEE-C3-C4-C5-JUMPY-XANTIA- XSARA	DİFERANSİYEL SAĞ ÇIKIŞ Dif.-Right/Left Output	312142	-	20026878	NA5490	27,94	56,00		8,00		L3TL SAĞ -Right	FKM
040883-P	BERLINGO-C5-SAXO-XSARA-BX-JUMPER	DİFERANSİYEL SAĞ ÇIKIŞ Dif.-Right Output	312126	96080792	20015497	128.240	29,85	47,00		11,30		L3TL SAĞ -Right	ACM
041276-PF	BERLINGO-C5-SAXO-XSARA-BX-JUMP- ER-ZX	DİFERANSİYEL SAĞ ÇIKIŞ Dif.-Right/Left Output	97504512	97504512	07011583	15007900	29,85	47,00		11,30		L3TL SAĞ -Right	ACM
041141-P	BERLINGO-C2-C3-C4-C5-NEMO-SAXO- XSARA-JUMPY-NEMO-DS3-DS5	DİFERANSİYEL SAĞ ÇIKIŞ Dif.-Right/Left Output	312146	312147	20028963	505.090	29,90	47,00		11,30		L3TL SAĞ -Right	ACM
045886-P	C11.4HDI	DİFERANSİYEL SAĞ ÇIKIŞ Dif.-Right/Left Output	6822EN	-	19026773	19026735	34,00	54,00		9,00	15,50	L3LR SAĞ -Right	ACM
045884-V	JUMPER	DİFERANSİYEL SAĞ ÇIKIŞ Dif.-Right/Left Output	71734264	55707298	01033292	-	35,00	54,90	61,00	9,00	14,70	SPL1L SS- RL	FKM
046237-P	JUMPER MULTİJET 3,0 D	DİFERANSİYEL SAĞ ÇIKIŞ Dif.-Right/Left Output	312160	-	01034875	-	45,00	64,85	71,20	8,90	14,70	SPL13TL SS-RL	ACM

DİFERANSİYEL GRUBU / Differential Group

SKT NO	KULLANILAN MODELLER Models	KULLANIM YERİ Place Of Use	ORJINAL NO 1 Original No 1	ORJINAL NO 2 Original No 2	EŞDEĞER NO 1 Equivalent No 1	EŞDEĞER NO 2 Equivalent No 2	ÖLÇÜLER MM. Dimensions - MM.				TİP Type	MALZEME Material	
045995-V	JUMPER	DİFERANSİYEL SAĞ ÇIKIŞ Dif.-Right/Left Output	301028	301033	07019090	381.710	34,90	54,00		11,30		L3TL SAĞ -Right	FKM
045887-P	C11.4HDI	DİFERANSİYEL SOL ÇIKIŞ Differential Left Output	6822EP	-	19034041	-	34,00	63,00		9,00	15,50	L3LR SOL -Left	ACM
046238-PF	C-ELYSEE-C3-C4-C5-JUMPY-XANTIA- XSARA	DİFERANSİYEL SOL ÇIKIŞ Differential Left Output	312164	-	20034245	-	40,00	54,00		6,80		SPL3TL SOL-Left	ACM+PTFE
046240-VAE	C3-C4-C5-JUMPY-XSARA-ZX	DİFERANSİYEL SOL ÇIKIŞ Differential Left Output	312140	-	20026877	-	40,00	54,00		6,80		L3TL SOL -Left	FKM+AEM
046123-VP	BERLINGO-JUMPER-C3-C4-C5-SAXO- XSARA-NEMO	DİFERANSİYEL SAĞ-SOL ÇIKIŞ Differential Right-Left Output	312144	236210	20020137	504.581	40,00	58,00		10,00		L3TL SS- RL	FKM+ACM
047872-P	BERLINGO-SAXO-XSARA-XANTIA- JUMPY	DİFERANSİYEL SOL ÇIKIŞ Differential Left Output	312127	96080067	07015496	102.946	40,00	58,00		11,30		SPL3TL- LLSS-RL	ACM
046181-PF	BERLINGO-SAXO-XSARA	DİFERANSİYEL SOL ÇIKIŞ Differential Left Output	9632349280-	9677263580	7015496	128.250	40,00	58,00	-	11,30	-	SPL3TL SOL-Left	ACM+PTFE
045994-V	JUMPER	DİFERANSİYEL SOL ÇIKIŞ Differential Left Output	301027	-	07019089	381.690	43,00	59,00		10,00		L3TL SOL -Left	FKM
046220-VL	JUMPER-XM	DİFERANSİYEL SOL ÇIKIŞ Differential Left Output	301027	-	07019089	381.690	43,00	59,00		10,00		SPL3TL SOL-Left	FKM+TPU

ŞANZİMAN GRUBU / Gearbox Group

SKT NO	KULLANILAN MODELLER Models	KULLANIM YERİ Place Of Use	ORJINAL NO 1 Original No 1	ORJINAL NO 2 Original No 2	EŞDEĞER NO 1 Equivalent No 1	EŞDEĞER NO 2 Equivalent No 2	ÖLÇÜLER MM. Dimensions - MM.				TİP Type	MALZEME Material	
040884	BERLINGO-C3-C4-C5-XSARA-C15-BX	ŞANZİMAN ÖN Gearbox Front	210940	96077209	07015547	131.860	23,00	36,00		7,00		L3TL SAĞ -Right	NBR
041268-P	C4-C5-DS3-DS5-JUMPY-DS4-DS5	ŞANZİMAN ÖN Gearbox Front	210962	-	07034872	-	26,80	41,00		9,20		SPL3TL SAĞ-Right	ACM
040168	C25-AX-BX-ZX	ŞANZİMAN ÖN Gearbox Front	902678	948350409	12010874	164.500	28,00	40,00		7,00		L3	NBR
040756	C25-EM	ŞANZİMAN ÖN Gearbox Front	10	-	12000135	12011030	28,00	47,00		7,00		L3L	NBR
046226-P	XSARA 1.6i	ŞANZİMAN ARKA Gearbox Rear	0239975447	0239978747	01031902	82031902	42,00	62,00		8,00		L13TL SOL -Left	ACM
040261	JUMPER	ŞANZ. KLM ÇIKIŞ MİLİ Speedometer Shaft	265104	9750254580	46081904	-	8,00	16,00		7,00		L3	NBR

ŞANZIMAN GRUBU / Gearbox Group

SKT NO	KULLANILAN MODELLER Models	KULLANIM YERİ Place Of Use	ORJINAL NO 1 Original No 1	ORJINAL NO 1 Original No 2	EŞDEĞER NO 1 Equivalent No 1	EŞDEĞER NO 1 Equivalent No 2	ÖLÇÜLER MM. Dimensions - MM.					TİP Type	MALZEME Material
041060-P	JUMPER	VİTES SEÇİCİ MİLİ Gear Selection Shaft	254116	-	07019091	-	18,00	28,00		6,50		L3TL	ACM

DİREKSİYON GRUBU / Steering Group

SKT NO	KULLANILAN MODELLER Models	KULLANIM YERİ Place Of Use	ORJINAL NO 1 Original No 1	ORJINAL NO 1 Original No 2	EŞDEĞER NO 1 Equivalent No 1	EŞDEĞER NO 1 Equivalent No 2	ÖLÇÜLER MM. Dimensions - MM.					TİP Type	MALZEME Material
041134	JUMPER	DİREKSİYON KUTUSU Steering Box	-	-	12012530	-	19,05	34,60		6,20	9,20	L3BL	NBR
041124	JUMPER	DİREKSİYON KUTUSU Steering Box	-	-	12014254	-	23,30	29,70		4,00		L2	NBR
041127-H	JUMPER	DİREKSİYON MİLİ Steering Shaft	-	-	15019947	-	30,00	42,50		6,50		L3BT	HNBR
041228-HL	-	DİREKSİYON SİSTEMİ Steering System	-	-	-	-	30,00	42,50	49,00	7,40	10,90	SPL3BT	HNBR+TPU
041317-HL	OTOMOBİL	HİDROLİK DİREKSİYON Steering Box	963665808A	-	01029602	82029602	24,00	36,00	37,00	8,50	17,70	SPL13BTL	HNBR+TPU

MOTOR GRUBU / Engine Group

SKT NO	KULLANILAN MODELLER Models	KULLANIM YERİ Place Of Use	ORJINAL NO 1 Original No 1	ORJINAL NO 2 Original No 2	EŞDEĞER NO 1 Equivalent No 1	EŞDEĞER NO 2 Equivalent No 2	ÖLÇÜLER MM. Dimensions - MM.				TİP Type	MALZEME Material	
041282-V	LOGAN-SANDERO 1.2 MOT.	KRANK ÖN Crank Shaft Front	7700873534	-	12025770	050.540	32,00	44,00		6,00		L3TL SAÇ -Right	FKM
041283-FP	LOGAN-SANDERO 1.2 16V	KRANK ÖN Crank Shaft Front	7701473494	-	20029612	169.620	32,00	44,00		6,00		F2TL SAÇ -Right	PTFE+ACM
041114-V	LOGAN 1.4-1.6I-SOLENZA 1.4	KRANK ÖN Crank Shaft Front	7700273776	-	20019851	504.483	35,00	47,00		6,00		L3TL SAÇ -Right	FKM
041116-FP	LOGAN 1.5 DCI-K4M-K4J 1.4 16V	KRANK ÖN Crank Shaft Front	7701475009	-	20034106	431.420	35,00	47,00		7,00		F2TL SAÇ -Right	PTFE+ACM
040329-S	LOGAN 1.1-1.3-1.4	KRANK ÖN Crank Shaft Front	7701348114	7703087075	12011547	302.589	35,00	50,00		8,00		L3 SAÇ -Right	VMQ
046007-V	SOLENZA 1.9 D	KRANK ÖN Crank Shaft Front	7700103245	-	12018755	157.200 981.480	42,00	54,00		6,00		L3TL SAÇ -Right	FKM
047904-FP	LOGAN-SANDERO 1.2 MOT.	KRANK ARKA Crank Shaft Rear	7701473493	-	20029611	169.650	70,00	86,00		7,00		F2TL SOL -Left	PTFE+ACM
047049-S	LOGAN 1.1-1.3-1.4	KRANK ARKA Crank Shaft Rear	7700517058	-	16012790	513.326	70,00	90,00		10,00		L3 SOL -Left	VMQ
047650-V	LOGAN-SOLENZA-DUSTER-SANDERO 1.4-1.6 16V-1.5 DCI-K4M-K4J	KRANK ARKA Crank Shaft Rear	7700859692	7700743161	12015352	507.822 81-18304-50	80,00	100,00		8,00		L3TL SOL -Left	FKM
047832-FP	LOGAN-DOKKER-DUSTER-LODGY-SAN- DERO 1.5 DCI	KRANK ARKA Crank Shaft Rear	7701473544	8200043463	20030112 21034107	745.740	80,00	100,00		9,00		F2TL SOL -Left	PTFE+ACM
410497-V	DOKKER-LODGY 1.2 TCE	KRANK ARKA Crank Shaft Rear	12279ED000	7701065057	19034989	471.060	84,00	117,00		8,50		L3TL SOL -Left	FKM
410503-VAE	SOLENZA 1.9 D	KRANK ARKA Crank Shaft Rear	7703087224- 4404963-9112964	1227900QAB	20018246	711.720	85,00	105,00		6,80	11,00	L3TL SOL -Left	FKM+AEM
410276-V	SOLENZA 1.9 D	KRANK ARKA Crank Shaft Rear	7700595940	7700714701	12012347 12015424	135110 81-23708-50	85,00	105,00		12,00		L3TL SOL -Left	FKM
040692-V	SOLENZA 1.9 D	EKSANTRİK MİLİ Cam Shaft	7703087192	-	12015425	508.544	25,00	42,00		6,00		L3T SAÇ -Right	FKM
041115-V	DOKKER-DUSTER-LODGY-SANDERO-LO- GAN 1.4 16V-1.5 DCI-K4M-K4J	EKSANTRİK MİLİ Cam Shaft	7701471376	-	12018754	073.890	28,00	42,00		5,00		L3TL SAÇ -Right	FKM
041278-FP	DOKKER-DUSTER-LOGAN-LODGY-SAN- DERO 1.5 DCI-1.6 16V-K9K /K4M	EKSANTRİK MİLİ Cam Shaft	7701474149	7701478550	20035460	584.880 81-38506-00	28,00	42,00		6,00		F2TL SAÇ -Right	PTFE+ACM
040695-P	LOGAN-SANDERO 1.2 16V	EKSANTRİK MİLİ Cam Shaft	7701473495	-	20027969	159.714	28,00	47,00		8,00		L3L SAÇ -Right	ACM
041281-FP	LOGAN-SANDERO 1.2 16V D4F 732-740	EKSANTRİK MİLİ Cam Shaft	7701473495	-	20027969	159.714	28,00	47,00		8,00		F2TL SAÇ -Right	PTFE+ACM

MOTOR GRUBU / Engine Group

SKT NO	KULLANILAN MODELLER Models	KULLANIM YERİ Place Of Use	ORJINAL NO 1 Original No 1	ORJINAL NO 1 Original No 2	EŞDEĞER NO 1 Equivalent No 1	EŞDEĞER NO 1 Equivalent No 2	ÖLÇÜLER MM. Dimensions - MM.					TİP Type	MALZEME Material
041198-V	SANDERO-LOGAN-SOLENZA 1.4-1.6	EKSANTRİK MİLİ Cam Shaft	7700101348	8200934089	20019850	365.940	30,00	42,00		6,00		L3TL SAĞ -Right	FKM
45-059-V	1.4-1.6 16V BENZ. MOT-LOGAN-MCV 4KM-K4J	SUPAP Valve Stem Seal	7700103938	-	46023004	151.810	5,50	11,00	28,00	16,40		LSV5T	FKM
45-025-V	LOGAN 1.5 DCI	SUPAP Valve Stem Seal	7700109840	-	12014670	403.730 70-33512-00	6,00	8,80	12,20	6,00	10,00	LSV2T	FKM
45-033-V	SOLENZA 1.4	SUPAP Valve Stem Seal	8200234651	-	12015802 49472012	701.289 70-26058-00	7,00	9,80	13,20	5,00	10,00	LSV2T	FKM
45-021-V	SOLENZA 1.9 D	SUPAP Valve Stem Seal	8200266369	-	12014584 49472013	294.110	8,00	10,80	14,20	5,50	10,00	LSV2T	FKM

MOTOR CONTA GRUBU/Engine Gasket Group

SKT NO	KULLANILAN MODELLER Models	KULLANIM YERİ Place Of Use	ORJINAL NO 1 Original No 1	ORJINAL NO 1 Original No 2	EŞDEĞER NO 1 Equivalent No 1	EŞDEĞER NO 1 Equivalent No 2	ÖLÇÜLER MM. Dimensions - MM.					TİP Type	MALZEME Material
4C-002-70	LOGAN 1.5DCI (2005 VE SONRASI İÇİN)	SİLİNDİR KAPAK CONTASI Cylinder Head Gasket	8200360571	8200351353	61-36975-00	414240P/ 338.861	0,7 mm						
4C-002-51	LOGAN 1.5 DCI (040520=> K9K 714-800)	ALT TAKIM CONTA Gasket Set Crank Case	-	-	-	-	FKM (VİTON) Keçeli						
4C-002-50	LOGAN 1.5 DCI (040520=> K9K 714-800)	ALT TAKIM CONTA Gasket Set Crank Case	-	-	-	-	PTFE (TEFLON) Keçeli						
4C-002-30	LOGAN 1.5DCI (2005=>K9K 732/734/764/780/804/806/832)	ÜST TAKIM CONTA Cylinder Head Gasket Set	7701477501	-	02-36975-02	-	Silindir kapak contalı						
4C-002-31	LOGAN 1.5DCI (2005=>K9K 800/802/ 812/ 830/G724/700/702/704/)	ÜST TAKIM CONTA Cylinder Head Gasket Set	7701476729	-	02-36975-01	-	Silindir kapak contalı						

DİFERANSİYEL GRUBU / Differential Group

SKT NO	KULLANILAN MODELLER Models	KULLANIM YERİ Place Of Use	ORJINAL NO 1 Original No 1	ORJINAL NO 1 Original No 2	EŞDEĞER NO 1 Equivalent No 1	EŞDEĞER NO 1 Equivalent No 2	ÖLÇÜLER MM. Dimensions - MM.				TİP Type	MALZEME Material	
046259-P	SOLENZA 1.2-1.4-1.6 BENZ.MOT.	DİFERANSİYEL SAĞ ÇIKIŞ Dif.-Right Output	8200068744 8700276850	7701029132	01029132	050.560	27,95	56,00		7,00		L3TL SAĞ -Right	ACM
046117-P	LOGAN-LODGY-DOKKER-SANDERO 1.4-1.6I-1.5 DCI	DİFERANSİYEL SOL ÇIKIŞ Dif.-Left Output	8200110847	8200717349	01033808	964.880	40,00	55,00		8,00	13,00	L3TLR SS- RL	ACM
046118-FP	LOGAN-LODGY-DOKKER-SANDERO 1.4-1.6I-1.5 DCI	DİFERANSİYEL SAĞ ÇIKIŞ Differential Right Output	8200183825	8200621239	20033804	1954012	33,00	55,00		8,50	13,50	L3TFR SAĞ-Right	PTFE+ACM
046252-V	DUSTER-SANDERO 1.5 DCI-OTM. EDC TİP ŞANZ.	DİFER. SAĞ-SOL ÇIKIŞ OTM. Dif.-Right/Left Output-Auto.	383427234R	-	9009059560	-	40,00	55,00		8,50		L13TLL SS-RL	FKM

MOTOR GRUBU / Engine Group

SKT NO	KULLANILAN MODELLER Models	KULLANIM YERİ Place Of Use	ORJINAL NO 1 Original No 1	ORJINAL NO 1 Original No 2	EŞDEĞER NO 1 Equivalent No 1	EŞDEĞER NO 1 Equivalent No 2	ÖLÇÜLER MM. Dimensions - MM.					TİP Type	MALZEME Material
040812-V	ESPERO	KRANK ÖN Crank Shaft Front	646267	646262	12013858	755.141	26,00	42,00		8,00		L3TL SAĞ -Right	FKM
040880-P	KALOS-LACETTI-LANOS-NUBİRA-REZZO	KRANK ÖN Crank Shaft Front	96350161	-	12010674 19026772	277.142 440.720	30,00	42,00		7,00		L3TL SAĞ -Right	ACM
040800-V	LACETTİ 1.8 16V-NUBİRA	KRANK ÖN Crank Shaft Front	90183572	-	12013458	-	31,00	50,00		8,00		L13L SAĞ -Right	FKM
047681-V	KALOS 1.4-LACETTİ-LANOS-NUBİRA	KRANK ARKA Crank Shaft Rear	96376569	-	12013882	590.797	80,00	98,00		10,00		L13L SOL -Left	FKM
040815-V	KALOS 1.4-LACETTİ 1.8-LANOS-NUBİRA	EKSANTRİK MİLİ Cam Shaft	90280463	-	20011244	353.990 81-24909-10	35,00	48,00		7,00		L13TL SAĞ -Right	FKM
4S-025-V	LACETTİ-NUBİRA-LAGENZA 1.8-2.0 16V	SUPAP Valve Stem Seal	90410741	-	12014670	724.590 70-33512-00	6,00	8,80	12,20	6,00	10,00	LSY2T	FKM
4S-064-V	KORANDO-MUSSO-REXTON	SUPAP Valve Stem Seal	-	-	12014586 49472879	830.489	7,00	10,00	13,50	8,50		LSY2T	FKM
4S-026-V	LANOS-ESPERA 1.3-1.5-NUBİRA	SUPAP Valve Stem Seal	94580655	-	12015757	919.608	7,00	11,00	16,00	7,00	10,00	LSY4T	FKM

ŞANZİMAN GRUBU / Gearbox Group

SKT NO	KULLANILAN MODELLER Models	KULLANIM YERİ Place Of Use	ORJINAL NO 1 Original No 1	ORJINAL NO 1 Original No 2	EŞDEĞER NO 1 Equivalent No 1	EŞDEĞER NO 1 Equivalent No 2	ÖLÇÜLER MM. Dimensions - MM.					TİP Type	MALZEME Material
041199-V	LANOS 1.4-LANOS 1.3-1.5-NUBİRA	ŞANZİMAN ÖN Gearbox Front	90182168	-	12017271	440.710	23,00	35,00		8,00		L13L SAĞ -Right	FKM

MOTOR GRUBU / Engine Group

SKT NO	KULLANILAN MODELLER Models	KULLANIM YERİ Place Of Use	ORJINAL NO 1 Original No 1	ORJINAL NO 1 Original No 2	EŞDEĞER NO 1 Equivalent No 1	EŞDEĞER NO 1 Equivalent No 2	ÖLÇÜLER MM. Dimensions - MM.					TİP Type	MALZEME Material
040911-P	HIJET-CHARADE	KRANK ÖN Crank Shaft Front	9004311144	-	12011842	022.170	34,00	48,00		7,00		L3L SAĞ -Right	ACM
045890	ROCKY 2.8D	KRANK ÖN Crank Shaft Front	9031142007	-	19016643	-	41,00	55,00		6,00		L1L	NBR
045728-P	ROCKY 2.8D	KRANK ÖN Crank Shaft Front	9031142019	-	19015085 07011550	NJ344	42,00	60,00		8,00		L3T SAĞ -Right	ACM
047650-V	ROCKY 2.8D	KRANK ARKA Crank Shaft Rear	9031180009	9004311230	12015352 19015091	128.210 507.822	80,00	100,00		8,00		L3TL SOL -Left	FKM
040803-V	SIRION-YRV-TERIOS 1.3 MOT.	EKSANTRİK MİLİ Cam Shaft	9031135040	9031135021	19026732	010.360	35,00	49,00		6,00		L3L SAĞ -Right	FKM
45802	FEROZA-ROCKY	ARKA AKS Rear Axle	9004311250	-	19016649	-	52,00	65,00		9,00		L1L	NBR

DİFERANSİYEL GRUBU / Differential Group

SKT NO	KULLANILAN MODELLER Models	KULLANIM YERİ Place Of Use	ORJINAL NO 1 Original No 1	ORJINAL NO 1 Original No 2	EŞDEĞER NO 1 Equivalent No 1	EŞDEĞER NO 1 Equivalent No 2	ÖLÇÜLER MM. Dimensions - MM.					TİP Type	MALZEME Material
045886-P	APPLAUSE 1.6 16V	DİFERANSİYEL SAĞ ÇIKIŞ Differential Right Output	9031134023	-	19026735	19026773	34,00	54,00		9,00	15,50	L3LR SAĞ- Right	ACM

ŞANZİMAN GRUBU / Gearbox Group

SKT NO	KULLANILAN MODELLER Models	KULLANIM YERİ Place Of Use	ORJINAL NO 1 Original No 1	ORJINAL NO 1 Original No 2	EŞDEĞER NO 1 Equivalent No 1	EŞDEĞER NO 1 Equivalent No 2	ÖLÇÜLER MM. Dimensions - MM.					TİP Type	MALZEME Material
040604	HIACE	ŞANZİMAN ÖN Gearbox Front	9004310029	9004311141	19015048	-	30,00	45,00		8,00		L3L	NBR

MOTOR GRUBU / Engine Group

SKT NO	KULLANILAN MODELLER Models	KULLANIM YERİ Place Of Use	ORJINAL NO 1 Original No 1	ORJINAL NO 2 Original No 2	EŞDEĞER NO 1 Equivalent No 1	EŞDEĞER NO 2 Equivalent No 2	ÖLÇÜLER MM. Dimensions - MM.				TİP Type	MALZEME Material
041199-V	PANDA-PUNTO-PALIO-ALBEA-STRADA-SI-ENA 1.2 MOT.	KRANK ÖN Crank Shaft Front	40004200	7554279	12011305	440.710	23,00	35,00		8,00	L13L SAĞ -Right	FKM
041200-V	PANDA-SIENA-PUNTO-PALIO-BRAVA-LIN-EA-MAREA-1.2-1.4 8V/16V BENZİNLİ	KRANK ÖN Crank Shaft Front	46404094	71740681	12016529	069.540 81-37461-00	27,00	37,00		7,00	L13TL SAĞ -Right	FKM
040944-V	DOBLO-BRAVA-MAREA-BRAVO-LIN-EA-DUCATO-PANDA 1.6 JTD/1.9JTD	KRANK ÖN Crank Shaft Front	5646262	7628850	12018321	069.590	31,00	41,00		7,00	L13TL SAĞ -Right	FKM
046122-V	DOBLO-FIORINO-STRADA-LINEA-IDEA-PALIO-PUNTO-500-1.3 MJTD EURO 4/5/6	KRANK ÖN Crank Shaft Front	55186757	93177701	12019250 01029649	445.060	40,00	52,00		7,00	L13TL SAĞ -Right	FKM
046119-FP	SCUDO-DUCATO 2.8 JTD	KRANK ÖN Crank Shaft Front	9400127509	9456202980	20029116	026.750	40,00	55,00		6,40	F2TL SAĞ -Right	PTFE+ACM
045448	MURAT 124-131-KUŞ SERİSİ	KRANK ÖN Crank Shaft Front	40000050	60502891	12011455	325.007	40,00	56,00		7,00	L1 SAĞ -Right	NBR
045448-S	MURAT 124-131-KUŞ SERİSİ	KRANK ÖN Crank Shaft Front	40000050	60502891	12011455 12011457	325.007 059.790	40,00	56,00		7,00	L1 SAĞ -Right	VMQ
046161-V	SEDICI 1.6 16V	KRANK ÖN Crank Shaft Front	71741822	-	19034959	351.180 717.710	41,00	53,00		6,00	L3L SAĞ -Right	FKM
045968-V	DUCATO-SCUDO 1.9 D-TD 2.0 JTD	KRANK ÖN Crank Shaft Front	9614194980	9400127479	20015456	508.233 040.363	42,00	62,00		7,00	L13TL SAĞ -Right	FKM
046219-FP	DUCATO 3.0 MOT.	KRANK ÖN Crank Shaft Front	504056152	-	20034876	353.780	50,00	70,00		11,00	SPFPT2K SAĞ-Right	PTFE+ACM
047905-FPL	DUCATO 2.3 JTD	KRANK ÖN Crank Shaft Front	504087648	504227240	20034613	749.250	50,00	80,00		11,00	SPFT SAĞ -Right	PTFE+ ACM+TPU
047898-V	DUCATO 2.3 JTD MOT.	KRANK ÖN Crank Shaft Front	504014155	504123772	12019748 12018382	431.110	50,00	80,00		14,00	SC ETS1	FKM
047835-FL	DUCATO 2.2 HDI	KRANK ÖN Crank Shaft Front	9659901780	-	19036447	026.782	50,00	90,00		14,00	SPF SAĞ -Right	PTFE+TPU
417107-V	DUCATO 2.5-2.8 D-TD-TDI	KRANK ÖN Crank Shaft Front	98461673	500315684	12016918	199.220	70,00	158,00	180,00	16,00	SPL1L SAĞ-Right	FKM
046088-P	BIS 126-500-REGETA-UNO-1.1-1.3-1.4-1.6 MOT.	KRANK ARKA Crank Shaft Rear	40000160	-	12011464	12029760	53,00	68,00		10,00	L1 SOL -Left	ACM
047640-V	ALBEA-PALIO-BRAVO-MAREA-TEMPRA-TIPO-UNO-KUŞ SERİSİ	KRANK ARKA Crank Shaft Rear	40004350	-	12012069	440.780	64,00	80,00		8,00	L13TL SOL -Left	FKM
047343-S	KUŞ SERİSİ-124-131	KRANK ARKA Crank Shaft Rear	40004000	40004290	12001482	042.102	70,00	90,00		10,00	L1 SOL -Left	VMQ
047759-V	DOBLO-ALBEA-PALIO-BRAVO-PANDA-PUNTO-UNO-500 1.1-1.2 8V-1.4 8V-16V	KRANK ARKA Crank Shaft Rear	7724665	71754491	12015268	069.600	74,00	88,00		8,00	L13TL SOL -Left	FKM

MOTOR GRUBU / Engine Group

SKT NO	KULLANILAN MODELLER Models	KULLANIM YERİ Place Of Use	ORJINAL NO 1 Original No 1	ORJINAL NO 2 Original No 2	EŞDEĞER NO 1 Equivalent No 1	EŞDEĞER NO 2 Equivalent No 2	ÖLÇÜLER MM. Dimensions - MM.				TİP Type	MALZEME Material	
047601-P	KUŞ SERİSİ-TEMPRA-TIPO	KRANK ARKA Crank Shaft Rear	40004310	40002740	12001483 12001540	440.830	74,00	90,00		10,00		L13TL SOL -Left	ACM
047601-V	KUŞ SERİSİ-TEMPRA-TIPO	KRANK ARKA Crank Shaft Rear	40004300	40004120	12001540	440.830	74,00	90,00		10,00		L13TL SOL -Left	FKM
417136-V	500-BRAVO-DOBLO-LINEA-PANDA- PUNTO-STILO 1.2-1.4 16V-T-JET MOT.	KRANK ARKA Crank Shaft Rear	46539824	71718738	12018929	375.320	74,00	187,50	141,00	17,00		SPL1L 6 SOL-Left	FKM
047838-FP	DOBLO-FIORINO-ALBEA-LIN- EA-PALIO-PUNTO-1.3 MJTD 16V EURO 4/5/6	KRANK ARKA Crank Shaft Rear	55180937	93177284	20032405	428.970	78,00	100,00		9,00		F2TL SOL -Left	PTFE+ACM
047645-V	DOBLO-FIORINO-ALBEA-LIN- EA-PALIO-PUNTO-1.3 MJTD EURO 4/5/6	KRANK ARKA Crank Shaft Rear	55180937	93177284	20032405	428.970	78,00	100,00		10,00		L13TL SOL -Left	FKM
047910-FP	PALIO 1.4-1.6	KRANK ARKA Crank Shaft Rear	55355235	-	20034129	434.550 81-38236-00	80,00	98,00		14,60		SP F	PTFE+ACM
410493-V	DUCATO 2.3 JTD MOT.	KRANK ARKA Crank Shaft Rear	504010779	504101720	12019602 12019825	431.120	83,00	113,00		13,00	12,20	SC ETS1	FKM
410382-V	DUCATO-SCUDO 1.9 D-TD 2.0 JTD	KRANK ARKA Crank Shaft Rear	012728	9614379380	20015455	508.209	90,00	110,00		7,00		L3TL SOL -Left	FKM
410500-V	DUCATO 3,0 D	KRANK ARKA Crank Shaft Rear	504014232	504180969	12019863	353.090	90,00	120,00		12,50	13,00	SC ETS1	FKM
415185-V	DOBLO-MAREA-BRAVO-BRAVA-PUN- TO-CROMA-1.6-1.9 TD-JTD-MJET	KRANK ARKA Crank Shaft Rear	71718365 71713041	46435513 7750404	12015763	199.191	93,00	140,00	172,00	15,00		SPL1L SOL -Left	FKM
417108-V	DUCATO 2.5-2.8 D-TD-TDI	KRANK ARKA Crank Shaft Rear	99468744	504059361	12016920	199.230	114,00	171,00	177,00	13,00		SPL1L SOL -Left	FKM
041151-FP	SCUDO	EKSANTRİK MİLİ Cam Shaft	2S6Q6L270AA	1145953	20029115	026.740	27,00	47,00		7,00		F2TL SAĞ -Right	PTFE+ACM
041256-V	DUCATO-SCUDU-ULYSEE 2.0 HDI	EKSANTRİK MİLİ Cam Shaft	9400807289	-	20026123	153.740	27,00	47,00		7,00		L3TL SAĞ -Right	FKM
040789-V	DOBLO-BRAVO-BRAVA-CROMA-MAR- EA-PALIO-1.4 12V-1.9 TD-JTD	EKSANTRİK MİLİ Cam Shaft	40004400	60809849	12011839	505.838	30,00	42,00		7,00		L3T SAĞ -Right	FKM
040597-S	MURAT 131-SERÇE	EKSANTRİK MİLİ Cam Shaft	5957615	40004250	12001470	440.730	30,00	43,00		8,00		L1 SAĞ -Right	VMQ
040675-P	TEMPRA-KUŞ SERİSİ-CROMA 1.6-1.8 MOT.	EKSANTRİK MİLİ Cam Shaft	40004250	5957615	12001470	440.730	30,00	43,00		8,00		L13TL SAĞ -Right	ACM
041247-V	1.6-1.9-2.0 MJTD-JTDM-MJET DUCATO-DOB- LO-SCUDO-LINEA-EGEA-PUNTO-STILO	EKSANTRİK MİLİ Cam Shaft	46802577	-	12018345	434.500	30,00	45,00		7,00		L13TL SAĞ -Right	FKM
045583-P	124-131-KUŞ SERİSİ	EKSANTRİK MİLİ Cam Shaft	40000470	40004460	12011539	212.458	30,00	52,00		7,00		L1 SAĞ -Right	ACM

MOTOR GRUBU / Engine Group

SKT NO	KULLANILAN MODELLER Models	KULLANIM YERİ Place Of Use	ORJINAL NO 1 Original No 1	ORJINAL NO 2 Original No 2	EŞDEĞER NO 1 Equivalent No 1	EŞDEĞER NO 2 Equivalent No 2	ÖLÇÜLER MM. Dimensions - MM.					TİP Type	MALZEME Material
045583-S	124-131-KUŞ SERİSİ	EKSANTRİK MİLİ Cam Shaft	40000470	-	12011539	212.458	30,00	52,00		7,00		L1 SAĞ -Right	VMQ
045819-P	TEMPRA-TIPO SERİSİ	EKSANTRİK MİLİ Cam Shaft	40000460	-	12012411	-	30,00	52,00	-	7,00	-	L13T SAĞ -Right	ACM
045844-P	SLX-ALBEA-MAREA-PALIO-TEMPRA-TIPO-FIORINO-1.6 16V-1.7D-1.9D	EKSANTRİK MİLİ Cam Shaft	40004930	60811964	12015854	332.220 440.750	30,00	52,00		7,00		L13TL SAĞ -Right	ACM
046242-V	PANDA-PUNTO-STRADA 1.2-1.4 MOT.	EKSANTRİK MİLİ Cam Shaft	55189997	-	12019439	688.580	31,00	55,00		7,00		L13TL SAĞ -Right	FKM
046218-V	DUCATO 2.3 JTD MOT.	EKSANTRİK MİLİ Cam Shaft	500350049	-	12017215	375.470	34,00	60,00		10,00		L13TL SAĞ -Right	FKM
040815-V	ALBEA-CROMA	EKSANTRİK MİLİ Cam Shaft	55352607	-	20011244	353.990	35,00	48,00		7,00		L13TL SAĞ -Right	FKM
040747-V	DUCATO-SCUDO-TEMPRA-ULYSSE 1.9 TD D8B	EKSANTRİK MİLİ Cam Shaft	9400807149	-	20018100	757.292	35,00	50,00		7,00		L3TL SAĞ -Right	FKM
040740-V	DUCATO-ULYSSE	EKSANTRİK MİLİ Cam Shaft	9400236149	-	19026017	-	35,00	50,00		8,00		L3TL SAĞ -Right	FKM
041287-V	DUCATO-ULLYSEE-SCUDO	EKSANTRİK MİLİ Cam Shaft	9400236499	-	20015457 07022633	505.366	36,00	50,00		7,00		L3TL SAĞ -Right	FKM
041293-FP	FIORINO 1.4 MOT.	EKSANTRİK MİLİ Cam Shaft	9653528780	-	19036293	505.100	36,00	50,00		8,00		F2TL SAĞ -Right	PTFE+ACM
041250-V	ULYSSEE	EKSANTRİK MİLİ Cam Shaft	9609874280	-	20018317	135.140 81-34146-00	38,00	50,00		6,00		L3TL SAĞ -Right	FKM
046217-V	500-EGEA-DOBLO-PUNTO-STILO-FIORINO-LINEA-PALIO-ALBEA 1.2 16V 80HP	EKSANTRİK MİLİ Cam Shaft	46434591	-	12016528 46085500	290.710	40,00	55,00		7,00		L13TL SAĞ -Right	FKM
045898-V	DOBLO-ALBEA-PALIO-BRAVO-PUNTO-UNO-TIPO-SCUDO-FIORINO 1.6 16V	EKSANTRİK MİLİ Cam Shaft	40004950	46425764	12015853	440.760	40,00	56,00		7,00		L13TL SAĞ -Right	FKM
045898-V	Y10-DEDRA-DELTA 1.6	EKSANTRİK MİLİ Cam Shaft	40004950	46425764	12015853	440.760	40,00	56,00		7,00		L13TL SAĞ -Right	FKM
045990-V	DUCATO-CROMA 2.4-2.5-2.8 D-TD-TDI	EKSANTRİK MİLİ Cam Shaft	98454041	98427998	12014728	419.730	55,00	70,00		8,00		L13TL SAĞ -Right	FKM
040880-P	DOBLO-ALBEA-PALIO-PUNTO-UNO-BRAVA 1.2 8V-1.6 16V-1.3-1.9 JTD	YARDIMCI MİL Auxiliary Shaft	40004240	5973907	12010674	277.142 440.720	30,00	42,00		7,00		L3TL SAĞ -Right	ACM
041206-P	ALBEA-BRAVO-1.6 16V-MAR-EA-PALIO-PUNTO-FIORINO-SCUDO	YARDIMCI MİL Auxiliary Shaft	40004960	7794301	12015927	-	30,00	47,00		7,00		L13TL SAĞ -Right	ACM
45-067-V	ALBEA-DOBLO-PUNTO-LINEA-PANDA-500SX 1.2-1.4 8V BENZİNLİ MOT.	SUPAP Valve Stem Seal	55190344	-	12017224	476.691 70-34223-00	5,00	7,80	11,00	8,00		LSY2T	FKM

MOTOR GRUBU / Engine Group

SKT NO	KULLANILAN MODELLER Models	KULLANIM YERİ Place Of Use	ORJINAL NO 1 Original No 1	ORJINAL NO 1 Original No 2	EŞDEĞER NO 1 Equivalent No 1	EŞDEĞER NO 1 Equivalent No 2	ÖLÇÜLER MM. Dimensions - MM.					TİP Type	MALZEME Material
45-057-V	1.6-1.9-2.0 MJTD-JTDM-DOBLO-DUCATO-LINEA-STILO-BRAVO-500SX	SUPAP Valve Stem Seal	55183812	-	19037053	506.550	5,00	10,00	23,40	15,40		LSY5T	FKM
45-045-V	1.2-1.3-1.4-1.6 16V- DOBLO-FIORINO-ALBEA-PALIO-LINEA-1.3 MJTD EURO 4/5/6	SUPAP Valve Stem Seal	46556651	46470334	12016586	069.630 70-33512-00	6,00	8,80	11,70	9,50		LSY2T	FKM
45-068-V	DUCATO-SCUDO-ULYSSE 2.0 HDI DW10	SUPAP Valve Stem Seal	9400956489	-	12016913	136.940	6,00	10,00	19,60	21,50		LSY5T	FKM
45-061-V	DUCATO 2.3-3.0 JTD MOT.	SUPAP Valve Stem Seal	500395378	-	12019782 49472021	718.210	6,00	10	22,00	19,00		LSY5T	FKM
45-033-V	1.2 8V-1.4-1.6 16V DOBLO-ALBEA-MAR-EA-PALIO-PANDA-TİPO	SUPAP Valve Stem Seal	46440885	7553616	12015802	701.289 70-26058-00	7,00	9,80	13,20	5,00	10,00	LSY2T	FKM
45-031-V	DUCATO 2.2 HDI EURO 5	SUPAP Valve Stem Seal	0956.59	1096253	19036760	-	7,00	12,00	24,15	13,80	18,60	LSY6T	FKM
45-021-V	1.3-1.2-1.4-1.6-1.7-1.9 TD-TDI-JTD-G9U-KUŞ SERİSİ TÜM MODELLER	SUPAP Valve Stem Seal	5996750	7553637	12014584 49472013	294.110	8,00	10,80	14,20	5,50	10,00	LSY2T	FKM
45-030-V	DUCATO 2.0-2.4-2.5-2.8 D-TD-TDI	SUPAP Valve Stem Seal	40101573	40101570	12015512 49472020	143.930 104.380	8,00	12,00	15,20	5,70	9,50	LSY2T	FKM
45-051-V	DUCATO 2.0-2.4-2.5-2.8 D-TD-TDI	SUPAP Valve Stem Seal	40101573	40101570	12015512 49472020	143.930 104.380	8,00	12,00	15,00	6,00	9,50	LSY2T	FKM
041303-V	STILO-CROMA	EKSANTRİK MİLİ Cam Shaft	71739825	-	20031720	056.900 81-35147-00	31,50	42,00		7,00		L13TL SAĞ -Right	FKM
040732-V	TEMPRA-TIPO-UNO 1.4-1.6 - SXA	ŞARJ DİNAMOSU Charger Shaft	71334210	-	-	-	12,50	20,00		5,00		L3T SOL -Left	FKM
041274-P	SCUDO DV6 MOT. - 1.6 MJET	ENJEKTÖR GÖVDE KEÇESİ Injector Body Seal	-	-	734.960	-	18,00	29,00		6,00		L2T	ACM

MOTOR CONTA GRUBU/Engine Gasket Group

SKT NO	KULLANILAN MODELLER Models	KULLANIM YERİ Place Of Use	ORJINAL NO 1 Original No 1	ORJINAL NO 1 Original No 2	EŞDEĞER NO 1 Equivalent No 1	EŞDEĞER NO 1 Equivalent No 2	ÖLÇÜLER MM. Dimensions - MM.	TİP Type	MALZEME Material
4C-005-71	LİNEA/EGEA/ALBEA/DOBLO/FİORİNO/PUNTO/ PANDA 1.3 JTD (EURO4/5/6)	SİLİNDİR KAPAK CONTASI Cylinder Head Gasket	55209071	-	61-36210-10	414187P/ 076.356	1 çentik - 0,82mm		
4C-006-71	BRAVO II/DOBLO/LİNEA/EGEA 1.6 D MULTİJET	SİLİNDİR KAPAK CONTASI Cylinder Head Gasket	55221094	-	61-38200-10	415269P/ 789.190	1 çentik - 0,92mm		
4C-007-71	DOBLO 1.9 JTD	SİLİNDİR KAPAK CONTASI Cylinder Head Gasket	46749905	-	61-35580-10	415099P/ 217.021	1 çentik - 0,92mm		

MOTOR CONTA GRUBU/Engine Gasket Group

SKT NO	KULLANILAN MODELLER Models	KULLANIM YERİ Place Of Use	ORJINAL NO 1 Original No 1	ORJINAL NO 2 Original No 2	EŞDEĞER NO 1 Equivalent No 1	EŞDEĞER NO 2 Equivalent No 2	ÖLÇÜLER MM. Dimensions - MM.	TİP Type	MALZEME Material
4C-008-70	DUCATO 2.3 JTD	SİLİNDİR KAPAK CONTASI Cylinder Head Gasket	5500387067	-	61-37080-00	389.430	1,10mm		
4C-008-71	DUCATO 2.3 JTD	SİLİNDİR KAPAK CONTASI Cylinder Head Gasket	5500387068	-	61-37080-10	389.440	1,20mm		
4C-008-72	DUCATO 2.3 JTD	SİLİNDİR KAPAK CONTASI Cylinder Head Gasket	5500387069	-	61-37080-20	389.450	1,30mm		
4C-005-72	LİNEA/EGEA/ALBEA/DOBLO/FİORİNO/ PUNTO/ PANDA 1.3 JTD (EURO4/5/6)	SİLİNDİR KAPAK CONTASI Cylinder Head Gasket	55209072	-	61-36210-20	414188P/ 076.408	2 çentik - 0,92mm		
4C-006-72	BRAVO II/DOBLO/LİNEA/EGEA 1.6 D MULTİJET	SİLİNDİR KAPAK CONTASI Cylinder Head Gasket	55221095	-	61-38200-20	789.200	2 çentik - 1,02mm		
4C-007-72	DOBLO 1.9 JTD	SİLİNDİR KAPAK CONTASI Cylinder Head Gasket	46749906	-	61-35580-20	415100P/ 217.031	2 çentik - 1,02mm		
4C-005-70	LİNEA/EGEA/ALBEA/DOBLO/FİORİNO/ PUNTO/ PANDA 1.3 JTD (EURO4/5/6)	SİLİNDİR KAPAK CONTASI Cylinder Head Gasket	55209070	-	61-36210-00	414186P/ 076.346	Çentiksiz - 0,72mm		
4C-006-70	BRAVO II/DOBLO/LİNEA/EGEA 1.6 D MULTİJET	SİLİNDİR KAPAK CONTASI Cylinder Head Gasket	55221093	-	61-38200-00	415268P/ 789.180	Çentiksiz - 0,82mm		
4C-007-70	DOBLO 1.9 JTD	SİLİNDİR KAPAK CONTASI Cylinder Head Gasket	46749904	-	61-35580-00	415098P/ 217.001	Çentiksiz - 0,82mm		
4C-005-30	LİNEA/EGEA/ALBEA/DOBLO/FİORİNO/ PUNTO/ PANDA 1.3 JTD (EURO4/5/6)	ÜST TAKIM CONTA Cylinder Head Gasket Set	71744285	-	-	-	Silindir kapak contasız		
4C-006-30	BRAVO II/DOBLO/LİNEA/EGEA 1.6 D MULTİJET	ÜST TAKIM CONTA Cylinder Head Gasket Set	71769851	-	02-42061-02	-	Silindir kapak contasız		
4C-007-30	DOBLO 1.9 JTD	ÜST TAKIM CONTA Cylinder Head Gasket Set	71718658	-	-	-	Silindir kapak contasız		
4C-005-11	LİNEA/EGEA/ALBEA/DOBLO/FİORİNO/ PUNTO/ PANDA 1.3 JTD (EURO4)	TAM TAKIM CONTA Full Set Gasket	71744285	71744286	-	-	FKM (VİTON) Keçeli - SKC'siz		
4C-005-10	LİNEA/EGEA/ALBEA/DOBLO/FİORİNO/ PUNTO/ PANDA 1.3 JTD (EURO4)	TAM TAKIM CONTA Full Set Gasket	71744285	71744286	-	-	PTFE (TEFLON) Keçeli - SKC' siz.		
4C-006-10	BRAVO II/DOBLO/LİNEA/EGEA 1.6 D MULTİJET	TAM TAKIM CONTA Full Set Gasket	-	-	-	-	Silindir kapak contasız		
4C-007-10	DOBLO 1.9 JTD	TAM TAKIM CONTA Full Set Gasket	71718129	-	-	-	Silindir kapak contasız		
4C-008-10	DUCATO 2.3 JTD (133429 NOLU MOTORDAN SONRASI İÇİN)	TAM TAKIM CONTA Full Set Gasket	504049360	-	-	-	Silindir kapak contasız		

AKS GRUBU / Axle Group

SKT NO	KULLANILAN MODELLER Models	KULLANIM YERİ Place Of Use	ORJINAL NO 1 Original No 1	ORJINAL NO 1 Original No 2	EŞDEĞER NO 1 Equivalent No 1	EŞDEĞER NO 1 Equivalent No 2	ÖLÇÜLER MM. Dimensions - MM.				TİP Type	MALZEME Material	
045449	MURAT 124-KUŞ SERİSİ	ÖN AKS Front Axle	40000780	-	12011501	013.035	40,00	57,15		10,00		L1	NBR
045704	SEDICI 1.9 DİZEL	ÖN AKS Front Axle	71741821	-	19027780	-	40,00	58,00		10,00		L3L	NBR
045584	KUŞ SERİSİ	ÖN AKS Front Axle	40001660	-	12011504	013.372	42,00	57,15		10,00		L1	NBR
047739	DUCATO 2.0-2.4-2.5-2.8 D-TD-TDI	ÖN AKS Front Axle	1313674080	1301221080	12015943	663P	70,00	90,00		13,50		L1L	NBR
040323	KUŞ SERİSİ-124-131	ARKA AKS Rear Axle	40000810	-	12011493	-	30,00	45,00		8,00		L1	NBR
045991	DUCATO 1.9-2.5-2.8 TD-TDI	ARKA AKS Rear Axle	935013350	1306356080	12014086	-	58,00	75,00		14,00	15,50	L13TL	NBR

DİFERANSİYEL GRUBU / Differential Group

SKT NO	KULLANILAN MODELLER Models	KULLANIM YERİ Place Of Use	ORJINAL NO 1 Original No 1	ORJINAL NO 1 Original No 2	EŞDEĞER NO 1 Equivalent No 1	EŞDEĞER NO 1 Equivalent No 2	ÖLÇÜLER MM. Dimensions - MM.				TİP Type	MALZEME Material	
045523	MURAT SERÇE-124-131-1.3	DİFERANSİYEL ÖN-MAHRUTİ Differential Front-Bevelgear	40000770	40002190	12011293	13055PRDA	36,00	68,00		10,00	11,00	L1CL SAĞ -Right	NBR
047480	KUŞ SERİSİ	DİFERANSİYEL ÖN-MAHRUTİ Differential Front-Bevelgear	40000200	40001540	12011462	-	46,00	78,00		10,00		L1L SAĞ -Right	NBR
047480-V	KUŞ SERİSİ	DİFERANSİYEL ÖN-MAHRUTİ Differential Front-Bevelgear	40000200	40001540	12011462	-	46,00	78,00		10,00		L1L SAĞ -Right	FKM
046234-V	ULYSSE	DİFERANSİYEL SAĞ ÇIKIŞ Dif.-Right Output	7703087210	-	20026878	NA5490	27,94	56,00		8,00		L3TL SAĞ -Right	FKM
041139-P	DOBLO-FIORINO-ALBEA-LIN- EA-PALIO-TEMPRA-STILO-PUNTO	DİFERANSİYEL SAĞ ÇIKIŞ Dif.-Right Output	40004760	71738498	12014825	13427PRDA	29,80	50,00		10,00	13,50	L13TLR SAĞ-Right	ACM
040883-P	SCUDO-TEMPRA-TIPO-UNO-STILO- 1.9-2.0 D-TD	DİFERANSİYEL SAĞ ÇIKIŞ Dif.-Right Output	9403121269	-	20015497	128.240	29,85	47,00		11,30		L3TL SAĞ -Right	ACM
041141-P	SCUDO-ULYSSE	DİFERANSİYEL SAĞ ÇIKIŞ Dif.-Right Output	9790464500	-	20028963	505.090	29,90	47,00		11,30		L3TL SAĞ -Right	ACM
045995-V	DUCATO 2.0-2.5-2.8 D-TD-TDI-HDI	DİFERANSİYEL SAĞ ÇIKIŞ Dif.-Right Output	301028	9649569280	07019090	381.710	34,90	54,00		11,30		L3TL SAĞ -Right	FKM

DİFERANSİYEL GRUBU / Differential Group

SKT NO	KULLANILAN MODELLER Models	KULLANIM YERİ Place Of Use	ORJINAL NO 1 Original No 1	ORJINAL NO 2 Original No 2	EŞDEĞER NO 1 Equivalent No 1	EŞDEĞER NO 2 Equivalent No 2	ÖLÇÜLER MM. Dimensions - MM.				TİP Type	MALZEME Material	
045899-P	DOBLO-ALBEA-PALIO-PUNTO-UNO-STILO-1.2-1.4-1.6-1.3 MJT	DİFERANSİYEL SAĞ ÇIKIŞ Dif.-Right Output	40004630	-	12015266	12036825	36,00	54,00		10,00	13,50	L13TLR SAĞ-Right	ACM
046121-P	DOBLO-FIORINO-LINEA-PALIO-TEMPRA-MAREA-STILO-TIPO-1.3-1.9 D-MJT-JTD	DİFERANSİYEL SOL ÇIKIŞ Differential Left Output	40004830	40003050	12014824	-	29,80	52,00		10,00	13,50	L13TLR SOL-Left	ACM
045900-P	DOBLO-ALBEA-PALIO-PUNTO-UNO-STILO-1.2-1.4-1.6-1.3 MJT	DİFERANSİYEL SOL ÇIKIŞ Differential Left Output	40004620	-	12015267	-	36,00	56,00		10,00	13,50	L13TLR SOL-Left	ACM
046238-PF	ULYSSE	DİFERANSİYEL SOL ÇIKIŞ Differential Left Output	7703087209	-	20034245	-	40,00	54,00		6,80		SPL3TL SOL-Left	ACM+PTFE
045994-V	DUCATO-2.5-2.8 D-TDI-JTD	DİFERANSİYEL SOL ÇIKIŞ Differential Left Output	9616785980	-	07019089	381.690	43,00	59,00		10,00		L3TL SOL -Left	FKM
046123-VP	DUCATO-SCUDO-ULYSSE 1.9-2.0-2.8 TD-JTD	DİFERANSİYEL SAĞ-SOL ÇIKIŞ Differential Right-Left Output	9603370680	9403121440	20020137	504.581	40,00	58,00		10,00		L3TL SS- RL	FKM
410389-P	DOBLO-ALBEA-MAREA-TEMPRA-TIPO-BRAVO-PALIO-PUNTO-UNO 1.3-1.9	DİFERANSİYEL SAĞ-SOL ÇIKIŞ Dif.-Right/Left Output	7634888	-	12012342	-	63,00	96,00	105,00	11,00		SPCL5	ACM
046220-VL	DUCATO	DİFERANSİYEL SOL ÇIKIŞ Differential Left Output	9616785980	-	07019089	381.690	43,00	59,00		10,00		SPL3TL SOL-Left	FKM+TPU
045883	CROMA	DİFERANSİYEL SAĞ-SOL ÇIKIŞ Dif.-Right/Left Output	71747834	90182165	12017376	452.500	35,00	54,00		10,00	15,00	L13TLR SS-RL	NBR
045884-V	DOBLO-FIORINO-CROMA-BRAVO-LINEA 1.3-1.9 MJT-JTD	DİFERANSİYEL SAĞ-SOL ÇIKIŞ Dif.-Right/Left Output	71734264	55707299	01033292	-	35,00	54,90	61,00	9,00	14,70	SPL1L SS- RL	FKM
047872-P	SCUDO-TEMPRA-ULYSSE	DİFERANSİYEL SAĞ-SOL ÇIKIŞ Dif.-Right/Left Output	9608006780	-	20020137	102.946	40,00	58,00		11,30		SPL13TLL SS-RL	ACM
046237-P	DUCATO 115 MULTİJET 2,0 D-3.0 D	DİFERANSİYEL SAĞ-SOL ÇIKIŞ Dif.-Right/Left Output	55207480	-	01034875	-	45,00	64,85	71,20	8,90	14,70	SPL13TL SS-RL	ACM
410389-P	DOBLO-ALBEA-MAREA-TEMPRA-TIPO-BRAVO-PALIO-PUNTO-UNO 1.3-1.9	DİFERANSİYEL SAĞ-SOL ÇIKIŞ Dif.-Right/Left Output	7634888	-	12012342	-	63,00	96,00	105,00	11,00		SPCL5	ACM

ŞANZİMAN GRUBU / Gearbox Group

SKT NO	KULLANILAN MODELLER Models	KULLANIM YERİ Place Of Use	ORJINAL NO 1 Original No 1	ORJINAL NO 2 Original No 2	EŞDEĞER NO 1 Equivalent No 1	EŞDEĞER NO 2 Equivalent No 2	ÖLÇÜLER MM. Dimensions - MM.				TİP Type	MALZEME Material	
040818-P	DOBLO-ALBEA-PALIO-PANDA-PUNTO-UNO 1.2 MPI-1.3 MJT-1.4 16V	ŞANZİMAN ÖN Gearbox Front	40004670	91111183	12014345	618RDAC	19,80	40,00		5,50	8,20	SPSL SAĞ -Right	ACM
041063-P	DOBLO-FIORINO-ALBEA-LINEA-MAREA-PALIO-PUNTO-TEMPRA	ŞANZİMAN ÖN Gearbox Front	40004820	40004030	12014316	13509PRDA	22,80	40,00		6,00	8,50	SLL SAĞ -Right	ACM

ŞANZIMAN GRUBU / Gearbox Group

SKT NO	KULLANILAN MODELLER Models	KULLANIM YERİ Place Of Use	ORJINAL NO 1 Original No 1	ORJINAL NO 2 Original No 2	EŞDEĞER NO 1 Equivalent No 1	EŞDEĞER NO 2 Equivalent No 2	ÖLÇÜLER MM. Dimensions - MM.				TİP Type	MALZEME Material
040884	SCUDO-ULYSSE 2.0 MOT.	ŞANZIMAN ÖN Gearbox Front	9614067080	-	07015547	131.860	23,00	36,00		7,00	L3TL SAĞ -Right	NBR
041292-P	BRAVO-CROMA-FIORINO-PUNTO- LINEA-QUBO	ŞANZIMAN ÖN Gearbox Front	55565322	-	1036358	-	24,50	41,00		6,00	L13TL SAĞ -Right	ACM
041288-P	BRAVO II 1.4-CROMA, PUNTO 1.9 D-FIORINO 1.3 CTDİ	ŞANZIMAN ÖN Gearbox Front	55180035	-	01033854	-	26,00	41,00		6,00	L13L SAĞ -Right	ACM
041268-P	ULYSSE-DUCATO	ŞANZIMAN ÖN Gearbox Front	9655315780	-	07034872	-	26,80	41,00		9,20	SPL3TL SAĞ-Right	ACM
040756	DUCATO-EM	ŞANZIMAN ÖN Gearbox Front	26126889	-	12000135	12011030	28,00	47,00		7,00	L3L	NBR
040322	MURAT 124-SERÇE	ŞANZIMAN ÖN Gearbox Front	40000260	40000180	12011445	13053RDAC	28,00	47,00		8,00	L1 SAĞ -Right	NBR
040322-P	MURAT 124-SERÇE	ŞANZIMAN ÖN Gearbox Front	40000260	40000180	12011445	13053RDAC	28,00	47,00		8,00	L1 SAĞ -Right	ACM
040481-P	KUŞ SERİSİ 1.6	ŞANZIMAN ÖN Gearbox Front	40002180	-	12011446	13373RDAC	28,00	48,60		8,00	L1 SAĞ -Right	ACM
040481-V	KUŞ SERİSİ 1.6	ŞANZIMAN ÖN Gearbox Front	40002180	-	12011446	13373RDAC	28,00	48,60		8,00	L1 SAĞ -Right	FKM
045447	MURAT 124	ŞANZIMAN ARKA Gearbox Rear	40000240	40002860	12011450	13073PRSA	32,00	56,00		10,00	L1L SOL -Left	NBR
045611-P	131-KUŞ SERİSİ	ŞANZIMAN ARKA Gearbox Rear	40000240	40002860	12011450	-	32,00	56,00		11,00	L1L SOL -Left	ACM
045611-V	131-KUŞ SERİSİ	ŞANZIMAN ARKA Gearbox Rear	40000240	40002860	12011450	-	32,00	56,00		11,00	L1L SOL -Left	FKM
040518	MURAT 124-131	ŞANZIMAN ÖN Gearbox Front	4223499	128196	-	-	22,00	40,00		9,00	SPL2TL	NBR
040596	KUŞ SERİSİ-131	ŞANZ. KLM ÇIKIŞ MİLİ Speedometer Shaft	40001950	-	-	-	6,00	12,00		5,00	L4 SAĞ -Right	NBR
040261	DUCATO	ŞANZ. KLM ÇIKIŞ MİLİ Speedometer Shaft	9750254580	-	46081904	-	8,00	16,00		7,00	L3	NBR
040552	MURAT-SERÇE (5 VİTES)	VİTES SEÇİCİ MİLİ Gear Selection Shaft	3900720	129042	-	-	16,00	26,00		8,00	SPL5L	NBR
041060-P	DUCATO	VİTES SEÇİCİ MİLİ Gear Selection Shaft	9616785580	-	07019091	-	18,00	28,00		6,50	L3TL	ACM
040817-P	BRAVO-PALIO-PANDA-PUNTO-UNO- DOBLO-STILO-MAREA-IDEA-500	VİTES SEÇİCİ MİLİ Gear Selection Shaft	40004800	40001700	12001623	610PAC	20,00	30,00		7,00	L13TL	ACM

DİREKSİYON GRUBU / Steering Group

SKT NO	KULLANILAN MODELLER Models	KULLANIM YERİ Place Of Use	ORJINAL NO 1 Original No 1	ORJINAL NO 2 Original No 2	EŞDEĞER NO 1 Equivalent No 1	EŞDEĞER NO 2 Equivalent No 2	ÖLÇÜLER MM. Dimensions - MM.					TİP Type	MALZEME Material
041137	DOBLO-DUCATO-SCUDO-ALBEA-BRAVA-MAREA-PALIO-TEMPRA	DİREKSİYON KUTUSU Steering Box	-	-	12014253	-	14,60	35,00		4,90		L2	NBR
040895	TEMPRA-TIPO-KUŞ SERİSİ-MAREA-BRAVO-UNO	DİREKSİYON KUTUSU Steering Box	34002505	-	12012530	-	19,00	34,70		6,20	9,20	SPL3BTL	NBR
041134	DOBLO-DUCATO-SCUDO-ALBEA-BRAVA-MAREA-PALIO	DİREKSİYON KUTUSU Steering Box	-	-	12012530	-	19,05	34,60		6,20	9,20	L3BL	NBR
041124	KUŞ SERİSİ	DİREKSİYON KUTUSU Steering Box	34002485	-	12014254	12011222	23,00	30,00		4,00		L2BT	NBR
041128	PALIO-SIENA-TEMPRA	DİREKSİYON KUTUSU Steering Box	-	-	12012050	-	23,00	34,30		6,35		L3B	NBR
041124	DOBLO-DUCATO-SCUDO-ALBEA-BRAVA-MAREA-PALIO	DİREKSİYON KUTUSU Steering Box	-	-	12014254	-	23,30	29,70		4,00		L2	NBR
041125	BRAVO-PALIO-TEMPRA	DİREKSİYON KUTUSU Steering Box	-	-	15020022	-	24,97	37,54	41,24	4,20	7,40	SPL3B	NBR
041130-H	DOBLO-ALBEA-BRAVO-MAREA	DİREKSİYON KUTUSU Steering Box	-	-	01030096	-	25,00	37,64		6,20		L3B	HNBR
040893	KUŞ SERİSİ	DİREKSİYON KUTUSU Steering Box	-	-	19026806	-	25,00	37,75		7,50		L3BT	NBR
041251-NL	TOFAŞ KUŞ SERİSİ (SKT 40913 YERİNE)	DİREKSİYON KUTUSU Steering Box	-	-	12012051	-	23,00	34,43	38,00	4,40	7,50	SPL3BT	NBR
040404	MURAT 124-131	DİREKSİYON KUTUSU Steering Box	40000800	-	12011489	-	28,00	43,00		10,00		L1	NBR
041127-H	UCATO	DİREKSİYON KUTUSU Steering Box	-	-	15019947	-	30,00	42,50		6,50		L3BT	HNBR
041228-HL	UCATO	DİREKSİYON KUTUSU Steering Box	-	-	-	-	30,00	42,50	49,00	7,40	10,90	SPL3BT	HNBR+TPU
041251-NL	TEMPRA-TIPO-KUŞ SERİSİ-MAREA-BRAVO-UNO	DİREKSİYON KUTUSU Steering Box	34003726	-	12012051	-	23,00	34,43	38,00	3,70	7,50	SPL3B	NBR+TPU
040892	KUŞ SERİSİ	DİREKSİYON KUTUSU Steering Box	-	-	15020022	-	24,90	37,75	41,20	4,50	7,50	SPL3B	NBR
041131-H	DOBLO-FIORINO-KUŞ SERİSİ	DİREKSİYON KUTUSU Steering Box	-	-	19029685	-	19,05	33,30		7,90		L12BL SAG-Right	HNBR

FREN GRUBU / Brake Group

SKT NO	KULLANILAN MODELLER Models	KULLANIM YERİ Place Of Use	ORJINAL NO 1 Original No 1	ORJINAL NO 1 Original No 2	EŞDEĞER NO 1 Equivalent No 1	EŞDEĞER NO 1 Equivalent No 2	ÖLÇÜLER MM. Dimensions - MM.				TİP Type	MALZEME Material
4D-284-T	KUŞ SERİSİ	FREN HİD.MRKZ.CONTASI Brake Hyd.Cylinder Gasket	4340334	-	-	-	11,30	27,00		13,00	MH	NR
4TM-054	KUŞ SERİSİ	ÖN AKS FREN SLD.TAM.TK. Front Axle Brake Cyl. Repair Kit	1900058	-	-	-					TM	-
4TM-062	KUŞ SERİSİ	FREN HİD.MRKZ.SİLİNDİRİ Brake Hyd.Cylinder	98000189	-	-	-						

DİĞER ÜRÜNLER / Other Products

SKT NO	KULLANILAN MODELLER Models	KULLANIM YERİ Place Of Use	ORJINAL NO 1 Original No 1	ORJINAL NO 1 Original No 2	EŞDEĞER NO 1 Equivalent No 1	EŞDEĞER NO 1 Equivalent No 2	ÖLÇÜLER MM. Dimensions - MM.		TİP Type	MALZEME Material
4B1-001-T	DKS - KUŞ SERİSİ	ÖN AMORTİSÖR TAKOZU Front Shock Absorber Mount	85006635	-	-	-	Ön Amortisör Üst			NR
4D-134-R	KUŞ SERİSİ	ÖN AMORTİSÖR KÖRÜĞÜ Shock Absorber Dust Bellow	4420024	-	-	-	Ön Amortisör Üst			SBR

MOTOR GRUBU / Engine Group

SKT NO	KULLANILAN MODELLER Models	KULLANIM YERİ Place Of Use	ORJINAL NO 1 Original No 1	ORJINAL NO 2 Original No 2	EŞDEĞER NO 1 Equivalent No 1	EŞDEĞER NO 2 Equivalent No 2	ÖLÇÜLER MM. Dimensions - MM.				TİP Type	MALZEME Material	
040738-P	ESCORT-GALAXY	KRANK ÖN Crank Shaft Front	1119747	1457183	12016518	546.968	28,00	42,00		7,00		L3TL SAĞ -Right	ACM
040738-V	ESCORT-GALAXY	KRANK ÖN Crank Shaft Front	1119747	1457183	16012080	546.968	28,00	42,00		7,00		L3TL SAĞ -Right	FKM
041077-FK	CONNECT-1.8 TDCI-FOCUS-MONDEO	KRANK ÖN Crank Shaft Front	1198045	XS4Q6700AB	20029769	026.770	30,00	50,00		7,50		F2TK SAĞ -Right	PTFE+YÜN
041272-FP	GALAXY-TAUNUS 1.3 - 1.9 TDI	KRANK ÖN Crank Shaft Front	1232133	3M216700AA	20026413	129.780	32,00	47,00		10,00		F2TL SAĞ -Right	PTFE+ACM
041169-V	FIESTA-FOCUS-FUSION-CMAX 1.25-1.4-1.6 16V 82-97-100HP-ZETEC-SE-FXJA-FXJB	KRANK ÖN Crank Shaft Front	6M5G6700BA	YS6G6700AA	15510081	023.590 81-33869-00	33,00	47,00		5,00		L3TL SAĞ -Right	FKM
041273-FP	ESCORT-FIESTA-GALAXY-SCORPIA-SIER-RA 1.1-1.3-1.6I-2.4-1.9TDI	KRANK ÖN Crank Shaft Front	1215960	2M2166700AA	20026412	155.560	35,00	48,00		10,00		F2TL SAĞ -Right	PTFE+ACM
040969-V	FIESTA	KRANK ÖN Crank Shaft Front	1074626	95VW6700BA	12010739	294.357 475.961	35,00	48,00		10,00		L3TL SAĞ -Right	FKM
040747-V	ESCORT-1.6-1.8-MONDEO 2.0	KRANK ÖN Crank Shaft Front	928M6700A5A	928M6700B5A	20018100	757.292	35,00	50,00		7,00		L3TL SAĞ -Right	FKM
046119-FP	FIESTA-FOCUS-FUSION-COURIER-CONNECT-MONDEO1.4-1.5-TDCI EURO 5	KRANK ÖN Crank Shaft Front	2S6Q6700AA	1142359	20029116	026.750	40,00	55,00		6,40		F2TL SAĞ -Right	PTFE+ACM
045448-S	ESCORT-GRANADA-TAUNUS-1.6-2.0	KRANK ÖN Crank Shaft Front	40000050	-	12011455	-	40,00	56,00		7,00		L1 SAĞ -Right	VMQ
046216-V	TRANSİT CUSTOM V363 PANTHER MOT.2.0 ECOBLUE	KRANK ÖN Crank Shaft Front	GK2Q6700AA	2089587	P93319-00	-	47,70	63,58		8,00		ETSL13TL SAĞ-Right	FKM
047835-FL	TRANSİT V184-347-V363 2.2-2.4 TDCI EURO 5	KRANK ÖN Crank Shaft Front	1557881- 1920072	357Q6700AA 357Q6700AD	19036447	026.782	50,00	90,00		14,00		SPF SAĞ -Right	PTFE+TPU
045980-P	RANGER-2.5 TD 1999-2002	KRANK ÖN Crank Shaft Front	3596216	XM346700AA	19033844	NA5197	53,00	69,85		11,00		L3L SAĞ -Right	ACM
047570-S	TRANSİT YORK DİZEL MOTOR	KRANK ÖN Crank Shaft Front	715F 6700 AA1B	-	-	-	66,67	85,98	-	9,52	-	L3 SS-RL	VMQ
047678-V	TRANSİT 2.5 SERİSİ	KRANK ÖN Crank Shaft Front	894F6700AA	1087566	15031900	15035976	66,67	86,10		9,52		L3TL SAĞ -Right	FKM
047838-FP	KA 1.3 TDCI	KRANK ARKA Crank Shaft Rear	-	-	20032405	428.970	78,00	100,00		9,00		F2TL SOL -Left	PTFE+ACM
047645-V	KA 1.3 TDCI	KRANK ARKA Crank Shaft Rear	-	-	20032405	428.970	78,00	100,00		10,00		L13TL SOL -Left	FKM
047440-S	ANADOL-1.2-1.3-1.6-ESCORT-TAUNUS2.0	KRANK ARKA Crank Shaft Rear	70HM6701A1A	01032209	505.680	-	78,98	95,45		11,11		L3T SOL -Left	VMQ

MOTOR GRUBU / Engine Group

SKT NO	KULLANILAN MODELLER Models	KULLANIM YERİ Place Of Use	ORJINAL NO 1 Original No 1	ORJINAL NO 2 Original No 2	EŞDEĞER NO 1 Equivalent No 1	EŞDEĞER NO 2 Equivalent No 2	ÖLÇÜLER MM. Dimensions - MM.				TİP Type	MALZEME Material
047440-S	FESTİVA	KRANK ARKA Crank Shaft Rear	70HM6701A1A	01032209	505.680	-	78,98	95,45		11,11	L3T SOL -Left	VMQ
047679-V	TRANSİT 2.5 SERİSİ	KRANK ARKA Crank Shaft Rear	894F6701AB	1087565	15015833	375.560	78,98	99,40		9,52	L3TL SOL -Left	FKM
047600-V	P-100-ANADOL-TAUNUS-TRANSIT-V183	KRANK ARKA Crank Shaft Rear	86HM6701A1A	1641893	763.713	-	79,38	95,65		11,11	L13TL SOL -Left	FKM
047836-FK	CONNECT-FOCUS-MONDEO 1.8 TDCI	KRANK ARKA Crank Shaft Rear	XS4Q6K301AF/AE	1078528 1207615	19036453	026.820	79,80	162,00	184,00	18,80	SPF5L SOL-Left	PTFE+YÜN
047851-FP	FIESTA-FOCUS-FUSION-CMAX 1.25 82HP- 1.6-1.6 16V 97-100HP-ZETEC-SE-FXJA-FXJB	KRANK ARKA Crank Shaft Rear	BM5G6K301AC	BM5G6K301AA	19036358	023.862 81-90011-00	80,00	182,00		19,40	SPF5L SOL-Left	PTFE+ACM
410443-FP	FIESTA-FOCUS-FUSION 1.4 TDCI -1.5 TDCI-1.6 TDCI EURO 5	KRANK ARKA Crank Shaft Rear	2S6Q6701AA	1142360	20029117 20034738	026.790	85,00	105,00		8,80	F2TL SOL -Left	PTFE+ACM
410345-V	ESCORT-1.6 MONDEO 1.8-2.0	KRANK ARKA Crank Shaft Rear	928M6701B5A	1663815	15510078	750.476	88,00	108,00		10,00	L13TL SOL -Left	FKM
417133-V	TRANSİT CUSTOM V363 PANTHER MOT.	KRANK ARKA Crank Shaft Rear	GK2Q6D354AA	2010453	81-90069-00	P93306-01	92,06	198,80	198,09	7,40	SP ETS1	FKM
410453-V	MONDEO-SIERRA 1.8i	KRANK ARKA Crank Shaft Rear	-	-	20018713	508.926	93,00	108,00		7,00	L3TL SOL -Left	FKM
412349-FK	TRANSIT V184-V347-V363 2.2-2.4 TDCI MONDEO 2.0-2.2 TDCI	KRANK ARKA Crank Shaft Rear	3S7Q6701AA / AB	1230864 1684285	20030332 82036539	026.812 026.811	106,00	190,00	196,00	15,20	SPF5L SOL-Left	PTFE+YÜN
041151-FP	FIESTA-FOCUS-FUSION-MONDEO 1.4 TDCI-1.6 TDCI EURO 5	EKSANTRİK MİLİ Cam Shaft	2S6Q6L270AA	1145953	20029115	026.740	27,00	47,00		7,00	F2TL SAĞ -Right	PTFE+ACM
041256-V	FOCUS-C MAX-KUGA-MONDEO-S MAX 2.0 TDCI	EKSANTRİK MİLİ Cam Shaft	3M5Q6L270BA	1231972	20026123	153.740	27,00	47,00		7,00	L3TL SAĞ -Right	FKM
041058-V	CONNECT-1.8 TDCI-FOCUS-MONDEO	EKSANTRİK MİLİ Cam Shaft	2M5Q6L270AA	6135090	12013949	562.653	28,00	38,00		7,00	L3TL SAĞ -Right	FKM
045554-S	ANADOL-1.2-1.3-1.6	EKSANTRİK MİLİ Cam Shaft	701M6700A1A	6139049	15015000 15012245	586.730	36,51	52,55		12,30	L3T SAĞ -Right	VMQ
046077-V	FIESTA-FOCUS-CMAX-FUSION 1.25-1.4-1.6 16V ZETEC-SE-FXJA-FXJB-HWDA-HWD8	EKSANTRİK MİLİ Cam Shaft	96MM6K922A2B 6M5G6K292BA	1004302 1471482	15510080	023.520 81-33871-00	38,00	52,00		6,00	L3TL SAĞ -Right	FKM
045901-V	ESCORT-FOCUS-CONNECT-1.6-1.8- MONDEO 2.0	EKSANTRİK MİLİ Cam Shaft	928M6K292B5A	1663822	15015834	467.860	42,00	53,00		7,00	L3TL SAĞ -Right	FKM
045624-S	ANADOL-1.2-1.3-1.6-TAUNUS 1.6-2.0	EKSANTRİK MİLİ Cam Shaft	70HM6700A1A	70HM6700A3A	12014404	757.497	42,00	56,00		7,00	L3T SAĞ -Right	VMQ

MOTOR GRUBU / Engine Group

SKT NO	KULLANILAN MODELLER Models	KULLANIM YERİ Place Of Use	ORJINAL NO 1 Original No 1	ORJINAL NO 2 Original No 2	EŞDEĞER NO 1 Equivalent No 1	EŞDEĞER NO 2 Equivalent No 2	ÖLÇÜLER MM. Dimensions - MM.					TİP Type	MALZEME Material
045765-V	P-100-ANADOL-TAUNUS-TRANSİT	EKSANTRİK MİLİ Cam Shaft	83HM6700A1A	1438274	15031987 15011250	757.497 344.400	42,00	56,00		7,00		LL3T SAĞ -Right	FKM
045258-VAE	FOCUS-KUGA-C-MAX-MONDEO 2.5 BENZ. MOT. ESKİ MOD.	EKSANTRİK MİLİ Cam Shaft	1439886	6G9N6K292AA 9440651	20026696	362.730	45,00	65,00		7,00		L3TL SAĞ -Right	FKM+AEM
046254-V	MONDEO 2.5 MOT.	EKSANTRİK MİLİ Cam Shaft	1371718	9458309	20026695	362.740	45,00	65,00		7,00		L3TL SAĞ -Right	FKM
046215-V	FOCUS-CMAX-MONDEO KUGA2 / 1.6 Gti- ZTEC 120-125 hp	EKSANTRİK MİLİ Cam Shaft	4M5G6K292CB	1319178	19036722	542.030	46,00	56,40		7,00		L3TL SAĞ -Right	FKM
045534	ANADOL-1300	EKSANTRİK MİLİ Cam Shaft	2724E6362A	-	-	-	46,43	66,80		11,11		L6	NBR
045881-V	TRANSİT SERİSİ 2,5 D	EKSANTRİK MİLİ Cam Shaft	894F6L270A	1087567	15015977	516.406	47,62	67,05		11,11		L3TL SAĞ -Right	FKM
045254-V	C,S,V 40-60-70-CX SERİSİ 1.6-1.8-2.0-2.4-2.5 BENZ.MOT. YM	EKSANTRİK MİLİ Cam Shaft	1371718-	6M5G6K292AA	20026695	362.740	51,00	65,00		7,00		L3TL SAĞ -Right	FKM
45-067-V	KA 1.2 BENZ. MOT..	SUPAP Valve Stem Seal	1535535	-	12017224	476.691	5,00	7,80	11,00	8,00		LSY2T	FKM
45-066-V	FIESTA IV-FOCUS III-KUGA-MONDEO V 1.0-1.5-1.6 ECOBOOST MOT.	SUPAP Valve Stem Seal	BM5G6571BA	1685838	82337066 12037066	317.020 70-37728-00	5,00	9,50	22,60	17,00		LSY5T	FKM
45-047-V	FIESTA-FOCUS-FUSION 1.6 TDCI	SUPAP Valve Stem Seal	3M5Q6571AA	1229886	19035752	-	5,50	9,50	18,10	14,00		LSYT	FKM
45-048-V	FIESTA-FUSION 1.4 TDCI- 1.5 TDCI-1.6 TDCI EURO5	SUPAP Valve Stem Seal	2S6Q6571AA	1145937	19035539	027.750	5,50	9,50	22,90	14,00	17,50	LSY5T	FKM
45-062-V	TRANSİT CUSTOM V362-V363 2.0 ECO- BLUE PANTHER MOT.	SUPAP Valve Stem Seal	GK2Q6571AA	2011589	70-12643-00	12039800	5,50	10,00	21,30	18,50		LSY5T	FKM
45-068-V	C-MAX-FOCUS-KUGA-MONDEO-S MAX 2.0 TDCI DW10 MOT.	SUPAP Valve Stem Seal	3M5Q6571BA	1231935	12016913	136.940	6,00	10,00	19,60	21,50		LSY5T	FKM
45-042-V	FIESTA-FOCUS-FUSION-C MAX 1.25 LT 82HP-1.6 16V -ZETEC-SE	SUPAP Valve Stem Seal	96HM6571AH 96MM6571BH	1005442 1095294	12014948 49472891	026.700/026.670 12-33876-01	6,00	11,00	23,00	13,00	16,00	LSY5T	FKM
45-027-V	ESCORT-MONDEO-FOCUS 1.6-1.8-2.0 BENZ.MOT.	SUPAP Valve Stem Seal	958M6571BC/ CB	7236260	12016587 12020287	127.510 127.490	6,00	12,00	24,00	14,00	20,00	LSY5T	FKM
45-026-V	SIERRA-SCORPIO 2.0	SUPAP Valve Stem Seal	6166533	88VM6571BB	49472019	919.608	7,00	11,00	16,00	7,00	10,00	LSY4T	FKM
45-031-V	MONDEO-RANGER-TRANSIT V184- 347-V363 2.2-2.4 - 3.2 TDCI EURO5	SUPAP Valve Stem Seal	XS7Q6571AD	1096253	19036760	027.740	7,00	12,00	24,15	13,80	18,60	LSY6T	FKM

MOTOR GRUBU / Engine Group

SKT NO	KULLANILAN MODELLER Models	KULLANIM YERİ Place Of Use	ORJINAL NO 1 Original No 1	ORJINAL NO 2 Original No 2	EŞDEĞER NO 1 Equivalent No 1	EŞDEĞER NO 2 Equivalent No 2	ÖLÇÜLER MM. Dimensions - MM.					TİP Type	MALZEME Material
45-007	ANADOL 1.3	SUPAP Valve Stem Seal	731M6571A1A	6008688	12004400	-	7,90	15,90	19,30	7,00	12,00	LA1	NBR
45-021-V	ESCORT-SIERRA	SUPAP Valve Stem Seal	1639190	95VW6571BA	12014584 12016850	294.110	8,00	10,80	14,20	5,50	10,00	LSY2T	FKM
45-041-V	CONNECT-1.8 TDCI	SUPAP Valve Stem Seal	86TM6571AB	1033027 1644647	12015512 49472020	761.389 104.380	8,00	12,00	15,50	5,50	9,50	LSY4T	FKM
45-030-V	P-100-FOCUS-MONDEO-TAUNUS-CONNECT 1.8-TD-TDCI	SUPAP Valve Stem Seal	1033027	86TM6571AB	12015512	761.389	8,00	12,00	15,20	5,70	9,50	LSY2T	FKM
45-051-V	P-100-FOCUS-MONDEO-TAUNUS 1.8-TD-TDCI	SUPAP Valve Stem Seal	1033027	86TM6571AB	12015512	761.389	8,00	12,00	15,00	6,00	9,50	LSY2T	FKM
45-002-P	P-100-ANADOL-TAUNUS	SUPAP Valve Stem Seal	70HM6571A3B 70HM6571A1A	1474550	12015511	173.053	8,00	12,00	18,50	6,30	9,50	LSY3T	ACM
45-028-V	TRANSİT M12-M15-V83 2.5 SERİSİ	SUPAP Valve Stem Seal	924F6571AA 924F6571A1A	6597036 T139213	467.880	-	8,93	14,73	29,30	17,45	23,40	LSY5T	FKM
041143-H	TRANSİT V184 2.4 TDCI	ENJEKTÖR GÖVDE KEÇESİ Injector Body Seal	YC1Q6K780BB	1121656	569.770	-	15,75	35,90		7,00		SPL3T	HNBR
041274-P	FOCUS-C MAX-FIESTA-FUSION 1.6 TDCI DV6 MOT.	ENJEKTÖR GÖVDE KEÇESİ Injector Body Seal	3M5Q9R524AA	1233683	734.960	-	18,00	29,00		6,00		L2T	ACM
041295-P	RANGER 2.5 2006 ->	ENJEKTÖR GÖVDE KEÇESİ Injector Body Seal	6M346700BA	4953750	-	-	20,00	28,13	29,00	9,30		SPL5	ACM
041187-P	TRANSİT V347	ENJEKTÖR GÖVDE KEÇESİ Injector Body Seal	6C1Q6K780AB	1372494	49364232	177.700	21,00	36,00	40,00	7,30		SPL3T	ACM
040110	TRANSİT 120-15	YAKIT POMPASI Fuel Pump	1549132	1491853	12010819	-	18,00	35,00		10,00		L3	NBR
040760	TRANSİT	YAKIT POMPASI-Bosch Tipi Fuel Pump-Bosch Type	79071380	-	12014600	82019584	20,00	31,00		7,00		L1B	NBR
040942-V	TRANSİT 15-M12	YAKIT POMPASI Fuel Pump	1460283311	42551388	12019586	-	20,00	31,00		7,30		L13TL	FKM
410441-FK	CONNECT-1.8 TDCI 2002>	YAKIT POMPASI Fuel Pump	XS4Q9G605AH	1078581	19036693	527.410	80,00	161,00	172,00	11,00		SPL5L	PTFE+YÜN
040799-V	TRANSİT 15-M12	ALTERNATÖR MİLİ Alternator Shaft	-	-	-	-	15,00	28,00		7,00		L3BT SAÇ-Right	FKM
040746-V	TRANSİT 15-2.0	VAKUM POMPASI Vacuum Pump	71WG7657BA	1498994	-	-	17,00	27,00		7,00		L3	FKM
040731-V	TRANSİT M-12-2.0 OHC	VAKUM POMPASI Vacuum Pump	-	-	-	-	17,00	28,00		7,00		L3 SS-RL	FKM

MOTOR GRUBU / Engine Group

SKT NO	KULLANILAN MODELLER Models	KULLANIM YERİ Place Of Use	ORJINAL NO 1 Original No 1	ORJINAL NO 2 Original No 2	EŞDEĞER NO 1 Equivalent No 1	EŞDEĞER NO 2 Equivalent No 2	ÖLÇÜLER MM. Dimensions - MM.				TİP Type	MALZEME Material	
040181	ANADOL-TAUNUS-TRANSİT M-12-2.5 DI	VAKUM POMPASI Vacuum Pump	-	-	-	-	19,05	35,03		6,35		L3	NBR
040914-V	TRANSIT V184	VAKUM POMPASI Vacuum Pump	-	-	-	-	20,00	32,00		7,00		L3BTL SAĞ-Right	FKM
046221-P	TRANSİT V184-V347-V362-V363-RANGER	VAKUM POMPASI Vacuum Pump	1C1Q2A454AC 1C1Q2A454AB	1211209- 1794375	-	-	65,00	70,00		9,00		SPCL	ACM
041296-P	TRANSIT V347-V363-RANGER 12- ARKA ÇEKER 2,2 TDCI	MOT.ÜST KAPAK CIVATA KEÇESİ Engine - Valve Cover Bolts	BK3Q9T529AB	1760813	-	-	7,50	18,00	23,00	6,20	8,00	SPL3T	ACM
4CN-066-V	TRANSIT V184-347	KARTER CONTASI Oil Pan Gasket	97JM6734BA	1005593	-	-	12,73	22,62		3,00		L	FKM

MOTOR CONTA GRUBU/Engine Gasket Group

SKT NO	KULLANILAN MODELLER Models	KULLANIM YERİ Place Of Use	ORJINAL NO 1 Original No 1	ORJINAL NO 2 Original No 2	EŞDEĞER NO 1 Equivalent No 1	EŞDEĞER NO 2 Equivalent No 2	ÖLÇÜLER MM. Dimensions - MM.				TİP Type	MALZEME Material
4C-011-70	FOCUS/FUSİON/MONDEO/C-MAX/CON- NECT/COURİER 1.6 TDCI	SİLİNDİR KAPAK CONTASI Cylinder Head Gasket	3M5Q 6051 CA	-	-	414114P/ 569.802	1 çentik - 1,35mm					
4C-011-71	FOCUS/FUSİON/MONDEO/C-MAX/CON- NECT/COURİER 1.6 TDCI	SİLİNDİR KAPAK CONTASI Cylinder Head Gasket	3M5Q 6051 AA	-	61-36265-00	414112P/ 569.812	2 çentik - 1,25mm					
4C-011-72	FOCUS/FUSİON/MONDEO/C-MAX/CON- NECT/COURİER 1.6 TDCI	SİLİNDİR KAPAK CONTASI Cylinder Head Gasket	3M5Q 6051 BA	-	-	414113P/ 569.820	3 çentik - 1,30mm					
4C-016-72	FİESTA VI/FOCUS II/B MAX/CONNECT/ COURİER 1.5TDCI	SİLİNDİR KAPAK CONTASI Cylinder Head Gasket	1703268	-	61-37945-20	49425005	3 çentik - 1,35mm					
4C-016-70	FİESTA VI/FOCUS II/B MAX/CONNECT/ COURİER 1.5TDCI	SİLİNDİR KAPAK CONTASI Cylinder Head Gasket	1703259	-	61-37945-00	49425001	4 çentik - 1,25mm					
4C-015-72	1.6 TDCI EURO5 MOTORLAR 1.6 TDCI (EURO5)	SİLİNDİR KAPAK CONTASI Cylinder Head Gasket	1698966	-	61-37940-20	49409418	4 çentik - 1,35mm					
4C-011-73	FOCUS/FUSİON/MONDEO/C-MAX/CON- NECT/COURİER 1.6 TDCI	SİLİNDİR KAPAK CONTASI Cylinder Head Gasket	3M5Q 6051 DA	1 229 890	-	414115P/ 569.832	4 çentik - 1,40mm					
4C-015-70	1.6 TDCI, EURO5 MOTORLAR 1.6 TDCI (EURO5)	SİLİNDİR KAPAK CONTASI Cylinder Head Gasket	1698964	-	61-37940-00	49409416	5 çentik - 1,25mm					
4C-016-71	FİESTA VI/FOCUS II/B MAX/CONNECT/ COURİER 1.5TDCI	SİLİNDİR KAPAK CONTASI Cylinder Head Gasket	1703267	-	61-37945-10	49425003	5 çentik - 1,30mm					
4C-011-74	FOCUS/FUSİON/MONDEO/C-MAX/CON- NECT/COURİER 1.6 TDCI	SİLİNDİR KAPAK CONTASI Cylinder Head Gasket	3M5Q 6051 EA	1 229 881	-	414116P/ 569.842	5 çentik - 1,45mm					
4C-015-71	1.6 TDCI EURO5 MOTORLAR 1.6 TDCI (EURO5)	SİLİNDİR KAPAK CONTASI Cylinder Head Gasket	1698965	-	61-37940-10	49409417	6 çentik - 1,30mm					

MOTOR CONTA GRUBU/Engine Gasket Group

SKT NO	KULLANILAN MODELLER Models	KULLANIM YERİ Place Of Use	ORJINAL NO 1 Original No 1	ORJINAL NO 2 Original No 2	EŞDEĞER NO 1 Equivalent No 1	EŞDEĞER NO 2 Equivalent No 2	ÖLÇÜLER MM. Dimensions - MM.	TİP Type	MALZEME Material
4C-016-73	FİESTA VI/FOCUS II/B MAX/CONNECT/ COURIER 1.5TDCI	SİLİNDİR KAPAK CONTASI Cylinder Head Gasket	1703270	-	61-37945-30	49425007	6 çentik - 1,40mm		
4C-015-73	1.6 TDCI EURO5 MOTORLAR 1.6 TDCI (EURO5)	SİLİNDİR KAPAK CONTASI Cylinder Head Gasket	1698967	-	61-37940-30	49409419	7 çentik - 1,40mm		
4C-016-74	FİESTA VI/FOCUS II/B MAX/CONNECT/ COURIER 1.5TDCI	SİLİNDİR KAPAK CONTASI Cylinder Head Gasket	1703275	-	61-37945-40	49425009	7 çentik - 1,45mm		
4C-015-74	1.6 TDCI, EURO5 MOTORLAR 1.6 TDCI (EURO5)	SİLİNDİR KAPAK CONTASI Cylinder Head Gasket	1698968	-	61-37940-40	49409490	8 çentik - 1,45mm		
4C-013-70	TRANSİT V-184 2.4 TDCI	SİLİNDİR KAPAK CONTASI Cylinder Head Gasket	5C1Q 6051 AA	1 256 146	61-35420-00	415422P/ 265.421	1 çentik - 1,10mm		
4C-014-70	TRANSİT - V347 2.2 TDCI (2006=>	SİLİNDİR KAPAK CONTASI Cylinder Head Gasket	6C1Q 6051AB	-	61-37365-00	415592P/ 156.201	1 çentik - 1,10mm		
4C-010-70	FİESTA/FUSİON 1.4 TDCI	SİLİNDİR KAPAK CONTASI Cylinder Head Gasket	1 146 051	2S6Q 6051CA	61-35430-20	414109P/ 100.420	1 çentik - 1,35mm		
4C-013-71	TRANSİT V-184 2.4 TDCI	SİLİNDİR KAPAK CONTASI Cylinder Head Gasket	5C1Q 6051 BA	1 256 130	61-35420-10	415423P/ 265.441	2 çentik - 1,15mm		
4C-014-71	TRANSİT - V347 2.2 TDCI (2006=>	SİLİNDİR KAPAK CONTASI Cylinder Head Gasket	6C1Q 6051BB	-	61-37365-10	415593P/ 156.211	2 çentik - 1,15mm		
4C-012-70	CONNECT 1.8 TDCI	SİLİNDİR KAPAK CONTASI Cylinder Head Gasket	1S4Q 6051 GA	-	-	415073P/ 027.062	2 çentik - 1,20mm		
4C-010-71	FİESTA/FUSİON 1.4 TDCI	SİLİNDİR KAPAK CONTASI Cylinder Head Gasket	1 146 049	2S6Q 6051AA	61-35430-00	414107P/ 100.400	2 çentik - 1,25mm		
4C-013-72	TRANSİT V-184 2.4 TDCI	SİLİNDİR KAPAK CONTASI Cylinder Head Gasket	5C1Q 6051 CA	1 256 149	61-35420-20	415424P/ 265.481	3 çentik - 1,20mm		
4C-014-72	TRANSİT - V347 2.2 TDCI (2006=>ÖNDEN ÇEKERLİ MODELLER	SİLİNDİR KAPAK CONTASI Cylinder Head Gasket	6C1Q 6051CB	-	61-37365-20	415594P/ 156.221	3 çentik - 1,20mm		
4C-012-71	CONNECT 1.8 TDCI	SİLİNDİR KAPAK CONTASI Cylinder Head Gasket	1S4Q 6051 HA	-	-	415074P/ 027.072	3 çentik - 1,25mm		
4C-010-72	FİESTA/FUSİON 1.4 TDCI	SİLİNDİR KAPAK CONTASI Cylinder Head Gasket	1 146 050	2S6Q 6051BA	61-35430-10	414108P/ 100.410	3 çentik - 1,30mm		
4C-012-72	CONNECT 1.8 TDCI	SİLİNDİR KAPAK CONTASI Cylinder Head Gasket	XS4Q 6051 CD	-	-	415075P/ 027.082	4 çentik - 1,30mm		
4C-010-73	FİESTA/FUSİON 1.4 TDCI	SİLİNDİR KAPAK CONTASI Cylinder Head Gasket	1 146 052	2S6Q 6051DA	61-35430-30	414110P/ 100.430	4 çentik - 1,40mm		
4C-012-73	CONNECT 1.8 TDCI	SİLİNDİR KAPAK CONTASI Cylinder Head Gasket	XS4Q 6051 DD	-	61-34315-30	415076P/ 027.092	5 çentik - 1,35mm		

MOTOR CONTA GRUBU/Engine Gasket Group

SKT NO	KULLANILAN MODELLER Models	KULLANIM YERİ Place Of Use	ORJINAL NO 1 Original No 1	ORJINAL NO 2 Original No 2	EŞDEĞER NO 1 Equivalent No 1	EŞDEĞER NO 2 Equivalent No 2	ÖLÇÜLER MM. Dimensions - MM.	TİP Type	MALZEME Material
4C-010-74	FİESTA/FUSİON 1.4 TDCI	SİLİNDİR KAPAK CONTASI Cylinder Head Gasket	1146 053	2S6Q 6051EA	61-35430-40	414111P/ 100.440	5 çentik - 1,45mm		
4C-012-74	CONNECT 1.8 TDCI	SİLİNDİR KAPAK CONTASI Cylinder Head Gasket	XS4Q 6051 ED	-	61-34315-40	415111P/ 027.102	6 çentik - 1,40mm		
4C-012-75	CONNECT 1.8 TDCI	SİLİNDİR KAPAK CONTASI Cylinder Head Gasket	XS4Q 6051 FD	-	61-34315-50	415112P/ 027.112	7 çentik - 1,45mm		
4C-010-30	FİESTA/FUSİON 1.4 TDCI	ÜST TAKIM CONTA Cylinder Head Gasket Set	-	-	-	-	Silindir kapak contasız		
4C-011-30	FOCUS/FUSİON/MONDEO/C-MAX /CONNECT/COURİER 1.6 TDCI	ÜST TAKIM CONTA Cylinder Head Gasket Set	-	-	-	-	Silindir kapak contasız		
4C-012-30	CONNECT 1.8 TDCI	ÜST TAKIM CONTA Cylinder Head Gasket Set	-	-	-	-	Silindir kapak contasız		
4C-015-30	1.5 TDCI/1.6 TDCI EURO5 MOTORLAR	ÜST TAKIM CONTA Cylinder Head Gasket Set	-	-	-	-	Silindir kapak contasız		
4C-013-10	TRANSİT V-184 2.4 TDCI	TAM TAKIM CONTA Full Set Gasket	XS4Q 6008 AAT	-	-	-	Enjektör Keçeli - SKC'siz.		
4C-013-11	TRANSİT V-184 2.4 TDCI	TAM TAKIM CONTA Full Set Gasket	XS4Q 6008 AAT	-	-	-	Enjektör Keçesiz - SKC'siz.		
4C-012-10	CONNECT 1.8 TDCI	TAM TAKIM CONTA Full Set Gasket	-	-	-	-	Mazot Pompa Keçeli - SKC'siz.		
4C-012-11	CONNECT 1.8 TDCI	TAM TAKIM CONTA Full Set Gasket	-	-	-	-	Mazot Pompa Keçesiz - SKC'siz		
4C-010-10	FİESTA/FUSİON 1.4 TDCI	TAM TAKIM CONTA Full Set Gasket	-	-	-	-	Silindir kapak contasız		
4C-011-10	FOCUS/FUSİON/MONDEO/C-MAX /CONNECT/COURİER 1.6 TDCI	TAM TAKIM CONTA Full Set Gasket	-	-	-	-	Silindir kapak contasız		
4C-014-10	TRANSİT - V347 2.2 TDCI (2006=>ÖNDEM ÇEKERLİ MODELLER)	TAM TAKIM CONTA Full Set Gasket	-	-	-	-	Silindir kapak contasız		
4C-015-10	1.5 TDCI/1.6 TDCI EURO5 MOTORLAR	TAM TAKIM CONTA Full Set Gasket	-	-	-	-	Silindir kapak contasız		
4C-017-10	TRANSİT (V363) 2.2 TDCI (EURO5 ARKADAN ÇEKER)	TAM TAKIM CONTA Full Set Gasket	-	-	-	-	Silindir kapak contasız		
4C-017-70	TRANSİT (V363) 2.2 TDCI (EURO5 ARKADAN ÇEKER)	SİLİNDİR KAPAK CONTASI Cylinder Head Gasket	BK3Q 6051 A1C	1717593- 1776498	61-43175-00	83403064	1 çentik - 1,10mm		
4C-017-71	TRANSİT (V363) 2.2 TDCI (EURO5 ARKADAN ÇEKER)	SİLİNDİR KAPAK CONTASI Cylinder Head Gasket	BK3Q 6051 B1C	1717595- 1776501	61-43175-10	83403063	2 çentik - 1,15mm		

MOTOR CONTA GRUBU/Engine Gasket Group

SKT NO	KULLANILAN MODELLER Models	KULLANIM YERİ Place Of Use	ORJINAL NO 1 Original No 1	ORJINAL NO 1 Original No 2	EŞDEĞER NO 1 Equivalent No 1	EŞDEĞER NO 1 Equivalent No 2	ÖLÇÜLER MM. Dimensions - MM.				TİP Type	MALZEME Material
4C-017-72	TRANSİT (V363) 2.2 TDCI (EURO5 ARKADAN ÇEKER)	SİLİNDİR KAPAK CONTASI Cylinder Head Gasket	BK3Q 6065 C1C	1717595- 1716502	61-43175-20	83403062	3 çentik - 1,20mm					

AKS GRUBU / Axle Group

SKT NO	KULLANILAN MODELLER Models	KULLANIM YERİ Place Of Use	ORJINAL NO 1 Original No 1	ORJINAL NO 1 Original No 2	EŞDEĞER NO 1 Equivalent No 1	EŞDEĞER NO 1 Equivalent No 2	ÖLÇÜLER MM. Dimensions - MM.				TİP Type	MALZEME Material	
040514	ANADOL-1300	ÖN AKS Front Axle	C8TA3178BA	-	-	-	21,83	25,10		1,98		L5	NBR
045225	TAUNUS-1.6-2.0	ÖN AKS Front Axle	71BB1190AB	1101837	12011157	-	40,00	55,00		8,00		L3	NBR
045713	FIESTA-KA-TAUNUS-P100-ESCORT	ÖN AKS Front Axle	1101837	1482324	12011157	039.993	40,00	55,00		8,00		L3TL	NBR
045124	ANADOL-1300	ÖN AKS Front Axle	400E1190A	-	-	-	41,28	60,40		9,52		SL	NBR
045816	TRANSİT 120-15-190-M12	ÖN AKS Front Axle	92VB1190AB	7127681	12017272	-	49,00	62,50		8,00	13,00	L5LR	NBR
045891	TRANSİT 120-15-190-M12	ÖN AKS Front Axle	92VB1190AA	-	-	-	49,00	62,50	77,50	9,50	13,00	SPL5LR	NBR
046017	FESTIVA	ÖN AKS İÇ Front Axle Inner	-	-	19016576	-	52,00	68,00		7,00	13,20	SPL5LR	NBR
045978	RANGER-2.5 TD 1999-2002	ÖN AKS Front Axle	OS11333067Y	S11333067	19026223	NJ892	52,00	70,00		9,00		L12L	NBR
047906	RANGER 2,5 D/2,5 -3,0 TDCİ	ÖN AKS- OTM. PORYALI 4X4 Front Axle - Auto.Hub 4x4	2M343N320AA	-	-	-	68,60	86,00	94,00	8,60	11,40	SPL1LR	NBR
046016	FESTIVA	ÖN AKS DIŞ Front Axle Outer	-	-	19016501	-	51,00	63,00		8,50		SPL5L	NBR
045924	RANGER-2.5 TD 1999-2002	ARKA AKS Rear Axle	3735772	XM341177CA	19019539	-	35,00	58,00		10,00		SPL3T	NBR
045903	ESCORT-FIESTA-KA	ARKA AKS Rear Axle	96FB1175AA	6199621	12017123	-	40,00	55,00		6,50		L5L	NBR
047685-V	TRANSIT V184	ARKA AKS Rear Axle	F75W1177BA	3896454	-	-	43,30	77,19	82,70	14,28	15,28	SPL1LL SS-RL	FKM
047252	TRANSİT	ARKA AKS Rear Axle	-	-	-	-	50,80	76,22		15,87		L5SL	NBR

AKS GRUBU / Axle Group

SKT NO	KULLANILAN MODELLER Models	KULLANIM YERİ Place Of Use	ORJINAL NO 1 Original No 1	ORJINAL NO 1 Original No 2	EŞDEĞER NO 1 Equivalent No 1	EŞDEĞER NO 1 Equivalent No 2	ÖLÇÜLER MM. Dimensions - MM.				TİP Type	MALZEME Material	
047402	ANADOL-1300-TRANSİT	ARKA AKS Rear Axle	71VB1175A	-	-	-	52,39	76,22		9,53	15,47	SPSL	NBR
047599	TRANSİT SERİSİ	ARKA AKS Rear Axle	76VB1157CA	83VB1175A2A	12012571	-	52,39	76,51		14,28		L3TLR SS- RL	NBR
047642	TRANSİT 120-190-M12	ARKA AKS Rear Axle	86VB1175A2A	86VB1175A3A	12012570	-	54,51	76,09		9,50	15,47	L3TLR SS- RL	NBR
047652	TRANSİT M-12-T15-120-190	ARKA AKS Rear Axle	92VB1175BA	-	-	-	63,00	78,00		9,50	15,50	L1LR	NBR
047201	TRANSİT SERİSİ	ARKA AKS (ÇİFT TEKER) Rear Axle	-	-	-	-	70,00	100,00		13,00		SL	NBR
410408-V	TRANSİT V184-347	ARKA AKS Rear Axle	5C161175AA	1521590	82036492	-	73,03	98,47	105,41	9,27	15,50	SPL1L SS- RL	FKM
410480-VP	TRANSİT V363 SERİSİ	ARKA AKS Rear Axle	4C3W1177AB 4C3W1177BA	4C3W1177EA BK3W1177AA	-	-	78,40	98,40	106,00	12,40	17,00	SC9	FKM+ACM
045823	TRANSİT 120-15-190-M12	ARKA AKS PORYA DIŞ Rear Axle Outer	92VB4233BA	-	-	-	35,00	54,00		11,00		L3TL SS- RL	NBR
047744	TRANSİT V184-347-TOURNEO	ARKA AKS (ÇİFT TEKER) DIŞ Rear Axle Outer	86VB1175B1A	6143628	12017122	-	56,95	82,00		7,00	14,00	SPL3L	NBR
045824	TRANSİT 120-15-190-M12	ARKA AKS PORYA İÇ Rear Axle Inner	86VB4233A2A	-	-	-	32,00	54,00		11,00		L3TL SS- RL	NBR
047745	TRANSİT V184-347-TOURNEO	ARKA AKS PORYA İÇ Rear Axle Inner	86VB1175C1A	6048469	12012569	-	69,60	100,00		12,70	20,70	SPL3TLR SS-RL	NBR

FREN GRUBU / Brake Group

SKT NO	KULLANILAN MODELLER Models	KULLANIM YERİ Place Of Use	ORJINAL NO 1 Original No 1	ORJINAL NO 1 Original No 2	EŞDEĞER NO 1 Equivalent No 1	EŞDEĞER NO 1 Equivalent No 2	ÖLÇÜLER MM. Dimensions - MM.				TİP Type	MALZEME Material	
4D-284-T	TRANSİT SERİSİ	FREN HİD.MRKZ.CONTASI Brake Hyd.Cylinder Gasket	L379082	-	-	-	11,30	27,00		13,00		MH	NR
4U-311-E	TRANSİT SERİSİ	FREN HİD.MRKZ.SİLİNDİRİ Brake Hyd.Cylinder	L379236	-	-	-	13,55	22,00		6,65		SPUCL	EPDM
4U-328-E	TRANSİT SERİSİ	FREN HİD.MRKZ.SİLİNDİRİ Brake Hyd.Cylinder	L379234	-	-	-	16,40	24,40		7,05	3,30	SPUCL	EPDM
4TM-049	M12-M15 TRANSİT SERİSİ	FREN HİD.MRKZ.SİLİNDİRİ Brake Hyd.Cylinder	-	-	-	-						TM	-
4TM-053	TRANSİT SERİSİ	FREN HİD.MRKZ.SİLİNDİRİ Brake Hyd.Cylinder	T020058	-	-	-						TM	-

DİFERANSİYEL GRUBU / Differential Group

SKT NO	KULLANILAN MODELLER Models	KULLANIM YERİ Place Of Use	ORJINAL NO 1 Original No 1	ORJINAL NO 2 Original No 2	EŞDEĞER NO 1 Equivalent No 1	EŞDEĞER NO 2 Equivalent No 2	ÖLÇÜLER MM. Dimensions - MM.					TİP Type	MALZEME Material
045459	ANADOL-1.2-1.3-1.6	DİFERANSİYEL ÖN-MAHRUTİ Differential Front-Bevelgear	105E4676B	1482506	NA583	-	39,69	72,62	55,95	8,70	18,26	SPSL	NBR
045640-V	ANADOL-1.2-1.3-1.6-2.0-TAUNUS	DİFERANSİYEL ÖN-MAHRUTİ Differential Front-Bevelgear	77BG4676A5A	92VB4676A1A	01026326	-	40,00	72,00		11,50		SPL1L SAĞ-Right	FKM
045639-V	P-100-ANADOL-TRANSİT SERİSİ	DİFERANSİYEL ÖN-MAHRUTİ Differential Front-Bevelgear	77GG4676A5A	92VB4676A1A	01026326	-	42,00	75,00		11,50		SPL1L SAĞ-Right	FKM
047733-V	P-100-TRANSİT-ANADOL-V184	DİFERANSİYEL ÖN-MAHRUTİ Differential Front-Bevelgear	95VB4676A1A	1042063	01035950	-	42,00	75,00	99,50	12,00	19,50	SPL1LR SAĞ-Right	FKM
047403	ANADOL-1300	DİFERANSİYEL ÖN-MAHRUTİ Differential Front-Bevelgear	204E4676	-	-	-	42,86	76,22		8,66	16,66	SPSL	NBR
047901-V	TRANSİT V363 ARKADAN ÇEKERLİ	DİFERANSİYEL ÖN-MAHRUTİ Differential Front-Bevelgear	1L3W4676AD	5262529	-	-	46,05	78,64	86,50	11,40	14,90	SPL1LLR SAĞ-Right	FKM
047763-V	TRANSIT V184-347	DİFERANSİYEL ÖN-MAHRUTİ Differential Front-Bevelgear	5C164676AA	-	-	-	47,60	80,14		9,70	16,10	SPL1LR SAĞ-Right	FKM
047741-P	TRANSIT V184-V347	DİFERANSİYEL ÖN-MAHRUTİ Differential Front-Bevelgear	3C164676AA	-	-	-	55,00	80,00		8,00	12,00	L3TLR SAĞ-Right	ACM
045900-P	KA	DİFERANSİYEL SOL ÇIKIŞ Differential Left Output	9S517052BA	1541080	12015267	-	36,00	56,00		10,00	13,50	L13TLR SOL-Left	ACM
046246-V	FIESTA-FOCUS-C-MAX 03-11 4 VİT. OTM 1,6 BENZ	DİFERANSİYEL SAĞ-SOL ÇIKIŞ Dif.-Right/Left Output	3S4P7H260AA	4508467	-	-	38,20	56,20	63,00	9,10	17,10	SPL1L SS- RL	FKM
045902-P	ESCORT-FIESTA-KA-FOCUS-FUSION- BMAX-CMAX-MONDEO-COURIER	DİFERANSİYEL SAĞ ÇIKIŞ Dif.-Right/Left Output	96WT- 3K169A9A	6656115	12019597	-	40,00	55,00		8,00		L13L SS- RL	ACM
046069-P	CONNECT-1.8-V184-347-MONDEO 1.6 TDCI	DİFER. SAĞ-SOL ÇIKIŞ Dif.-Right/Left Output	93ZT3K169A9C	1543933	49369114	-	40,00	55,00	62,00	13,00		SPSLLL	ACM
046268-P	MONDEO-SMAX 2.2 TDCI	DİFER. SAĞ-SOL ÇIKIŞ Dif.-Right/Left Output	1435684	666R7048AA	01025620	82025620	44,00	67,00		10,00	15,50	L13LR SS- RL	ACM
046245-P	V-347 SERİSİ	DİFERANSİYEL SAĞ-SOL ÇIKIŞ Dif.-Right/Left Output	8C1R3K169AA	1490305	-	-	45,00	60,00	67,00	13,00		SPL13TL SS-RL	ACM
046230-P	GALAXY	DİFERANSİYEL SAĞ-SOL ÇIKIŞ Dif.-Right/Left Output	1209334	-	01029144	454.820	60,00	74,00		8,00		L13L SS- RL	ACM

ŞANZIMAN GRUBU / Gearbox Group

SKT NO	KULLANILAN MODELLER Models	KULLANIM YERİ Place Of Use	ORJINAL NO 1 Original No 1	ORJINAL NO 1 Original No 2	EŞDEĞER NO 1 Equivalent No 1	EŞDEĞER NO 1 Equivalent No 2	ÖLÇÜLER MM. Dimensions - MM.					TİP Type	MALZEME Material
040828-P	ESCORT-1.3-1.4-1.6-1.816V-1.6D	ŞANZIMAN ÖN Gearbox Front	77TT7048AA	6028954/ 1075771	12017369	-	21,50	40,00		7,00		L3T SAĞ -Right	ACM
040420	ANADOL-1300	ŞANZIMAN ÖN Gearbox Front	211E7052B	-	-	-	27,00	41,19		9,92		L3	NBR
040533	ANADOL-1300	ŞANZIMAN ÖN Gearbox Front	69BB7052AA	-	-	-	27,00	41,28		9,52		L6 SAĞ -Right	NBR
041168-P	CONNECT-ESCORT-FOCUS-MONDEO-DİZ. MOT.	ŞANZIMAN ÖN Gearbox Front	91ZT7048A1A	6184211	12015750	-	27,00	42,00		6,00		L3TL SAĞ -Right	ACM
040483	ANADOL-1.2-1.3-1.6-2.0	ŞANZIMAN ÖN Gearbox Front	71WG7048AA	-	-	-	27,78	40,13		7,93		L1 SAĞ -Right	NBR
040755-P	TRANSIT V184-347-120-190-M12-T15	ŞANZIMAN ÖN Gearbox Front	878T7048A2A	878T7048AA	01031967	-	28,00	40,00		8,00		L3TL SAĞ -Right	ACM
046244-V	TRANSİT V362/V363 2.0 D PANTHER MOT.	ŞANZIMAN ÖN Gearbox Front	GK3R7048AA	2035081	-	-	35,00	52,00		6,00		L13TL SAĞ -Right	FKM
046213-V	TRANSİT V347 SERİSİ MT82 6 VİTES	ŞANZIMAN ÖN Gearbox Front	4C1R7048AA	1311157	01019289	-	35,00	52,00		7,00		L13TL SAĞ -Right	FKM
041297-P	FIESTA-FOCUS-CMAX-KA- MONDEO-PU- MA-STREET-KA 1.4-1.6-1.8 BENZ.	ŞANZIMAN ARKA Gearbox Rear	96WT7048A9A	1013800	19036891	-	21,50	48,00		8,40		SPL3L SAĞ-Right	ACM
040476	ANADOL-1.2-1.3-1.6-2.0	ŞANZIMAN ARKA Gearbox Rear	71WG7657BA	1498994	NA167	-	30,16	43,64		12,70		L12L SOL -Left	NBR
040621	SIERRA-TRANSIT-P100-ANADOL	ŞANZIMAN ARKA Gearbox Rear	72GG7657AA	1564630	12000635	-	34,92	49,80		12,70		L3TL SOL -Left	NBR
045976-P	RANGER-2.5 TD 1999-2002	ŞANZIMAN ARKA Gearbox Rear	3602087	XM347A292AA	19033798	-	38,00	51,00	58,00	13,00	15,00	SPL12CLL- SOL-Left	ACM
045836-P	ESCORT-TOURNEO-TRANSİT SERİSİ	ŞANZIMAN ARKA Gearbox Rear	878T7052AA	6152666	01030363	01033472	40,00	58,00		8,80		L13L SOL -Left	ACM

ŞANZIMAN GRUBU / Gearbox Group

SKT NO	KULLANILAN MODELLER Models	KULLANIM YERİ Place Of Use	ORJINAL NO 1 Original No 1	ORJINAL NO 1 Original No 2	EŞDEĞER NO 1 Equivalent No 1	EŞDEĞER NO 1 Equivalent No 2	ÖLÇÜLER MM. Dimensions - MM.				TİP Type	MALZEME Material	
045975-P	TRANSIT V184-347	ŞANZIMAN ARKA Gearbox Rear	YC1R7052AA / YC1R7052A2A	1108466	-	-	40,00	58,00		8,80	13,80	L13LR SOL -Left	ACM
045226-V	FOCUS II-KUGA-MONDEO-SMAX 2.5-2.0 TDCI	ŞANZIMAN ARKA Gearbox Rear	1366069	36GR7048BA	01034065	-	40,00	60,00		10,00		L3L	FKM
045593	ANADOL-1300	ŞANZIMAN ARKA Gearbox Rear	400E1190B1	-	-	-	44,45	60,50		9,52		L3	NBR
046214-P	TRANSIT V347-V348-V363 SERİSİ MT82 6 VİTES	ŞANZIMAN ARKA Gearbox Rear	4C1R7052BA 6C1R7052AA	1311148	01026401	-	52,00	68,00		8	13,00	L13TLR SOL-Left	ACM
040261	ANADOL-TAUNUS-1.6-2.0	ŞANZ. KLM ÇIKIŞ MİLİ Speedometer Shaft	265104	9750254580	46081904	-	8,00	16,00		7,00		L3	NBR
040456	ANADOL-1.2-1.3-1.6-2.0	VİTES SEÇİCİ MİLİ Gear Selection Shaft	72BG7288A2A	-	-	-	12,70	16,98		6,00	7,54	SPL2	NBR
040424	ANADOL-1.2-1.3-1.6	VİTES SEÇİCİ MİLİ Gear Selection Shaft	-	-	-	-	12,70	20,32		3,17		L5	NBR
041294	V184-V-347-RANGER SERİSİ	VİTES SEÇİCİ MİLİ Gear Selection Shaft	4C1R7288AB	4C1R7288AA	49389307	-	15,00	25,20		6,50	8,50	L2TLL	NBR
040901-P	TRANSIT V184-347	VİTES SEÇİCİ MİLİ Gear Selection Shaft	YC1R7288A2A	1555461	-	-	15,00	25,30		6,50		L2T	ACM
040819	ESCORT-1.6-1.8 16V	VİTES SEÇİCİ MİLİ Gear Selection Shaft	77TT7288AA	-	-	-	15,50	28,00	26,00	6,00	15,00	SPL1	NBR
4KIT-073	FIESTA-FOCUS-FUSION	VİTES SEÇİCİ MİLİ Gear Selection Shaft	98WT7288A2A	-	-	-						KIT	-
4TP-017	V-184-V347-V363 SERİSİ	ŞANZIMAN YAĞ TAPASI Gearbox Oil Plug	4C1R7665BA	1311152	-	-	-	52,00		7,00		T3	NBR

DİREKSİYON GRUBU / Steering Group

SKT NO	KULLANILAN MODELLER Models	KULLANIM YERİ Place Of Use	ORJINAL NO 1 Original No 1	ORJINAL NO 1 Original No 2	EŞDEĞER NO 1 Equivalent No 1	EŞDEĞER NO 1 Equivalent No 2	ÖLÇÜLER MM. Dimensions - MM.				TİP Type	MALZEME Material	
040895	TAUNUS-1.6-2.0	DİREKSİYON SİSTEMİ Steering System	34002505	-	12012530	-	19,00	34,70		6,20	9,20	SPL3BTL	NBR
041201	CONNECT-1.8-BİNEK GRUBU	DİREKSİYON MİLİ Steering Shaft	-	-	12015526	-	19,05	34,60		4,40	5,90	L3BTL	NBR

DİREKSİYON GRUBU / Steering Group

SKT NO	KULLANILAN MODELLER Models	KULLANIM YERİ Place Of Use	ORJINAL NO 1 Original No 1	ORJINAL NO 2 Original No 2	EŞDEĞER NO 1 Equivalent No 1	EŞDEĞER NO 2 Equivalent No 2	ÖLÇÜLER MM. Dimensions - MM.					TİP Type	MALZEME Material
041134	TRANSIT V184-ESCORT	DİREKSİYON KUTUSU Steering Box	-	-	12012530	-	19,05	34,60		6,20	9,20	L3BL	NBR
041126	ESCORT-1.6 16V	DİREKSİYON KUTUSU Steering Box	0770080273	0770198130	01016544	-	20,00	30,00		5,00	6,00	L3BTL	NBR
040841	TRANSİT 120-190-T15-M12	DİREKSİYON Mili Steering Shaft	0770198112D	5000810202	01020303	-	22,00	32,00		6,00		L3BTL	NBR
041119	TRANSİT TURBO	DİREKSİYON KUTUSU Steering Box	-	-	-	-	22,00	32,00		7,00		L3BL	NBR
041124	TAUNUS-1.6-2.0	DİREKSİYON SİSTEMİ Steering System	34002485	-	12014254	12051218	23,00	30,00		4,00		L2BT	NBR
041128	ESCORT-1.8 16V	DİREKSİYON KUTUSU Steering Box	-	-	12012050	-	23,00	34,30		6,35		L3B	NBR
041124	CONNECT-1.8-V184-ESCORT-TAUNUS	DİREKSİYON KUTUSU Steering Box	-	-	12014254	-	23,30	29,70		4,00		L2	NBR
040878	TRANSİT 120-190-T15-M12	DİREKSİYON Mili Steering Shaft	770080268	-	12010842	-	24,00	37,00		7,00		L3BTL	NBR
040892	TAUNUS-1.6-2.0	DİREKSİYON KUTUSU Steering Box	-	-	15020022	-	24,90	37,75	41,20	4,50	7,50	SPL3B	NBR
041125	FIESTA-FOCUS-FUSİON-TAUNUS-KA	DİREKSİYON KUTUSU Steering Box	-	-	15020022	-	24,97	37,54	41,00	4,20	7,40	SPL3B	NBR
040893	TAUNUS-1.6-2.0	DİREKSİYON KUTUSU Steering Box	-	-	19026806	-	25,00	37,75		7,50		L3BT	NBR
4TM-057	TRANSIT V184-M15	DİREKSİYON KEÇE TAMİR TAK. Steering System Repair Kit	92VB3L564BA	6869953	-	-						TM	-
040820	ANADOL-1.2-1.3-1.6 ZF 8033 TİP.KUTU	DİREKSİYON KUTUSU Steering Box	770080256	-	12001669	-	20,00	30,00		7,00	8,00	L3BTL	NBR
041130-H	CONNECT-FIESTA-FOCUS-FUSİON-KA	DİREKSİYON KUTUSU Steering Box	-	-	01030096	-	25,00	37,64		6,20		L3B	HNBR
040743	TRANSİT 120-190-T15-M12	DİREKSİYON KUTUSU Steering Box	770198103	42488743	12014826	006.408	26,00	37,00		7,00	8,00	L3BTL	NBR
041121-H	TRANSİT TURBO	DİREKSİYON KUTUSU Steering Box	-	-	01018101	-	26,00	37,00		7,00		L3BT	NBR
040758	TRANSİT 120-190-T15-M12	DİREKSİYON KUTUSU Steering Box	7852033113	-	12001680	-	30,00	40,00		7,00		L3BTL	NBR
041082	TRANSİT 120-190-T15-M13	DİREKSİYON KUTUSU Steering Box	-	-	-	-	30,00	40,00		7,00		SPL3B	NBR

DİREKSİYON GRUBU / Steering Group

SKT NO	KULLANILAN MODELLER Models	KULLANIM YERİ Place Of Use	ORJINAL NO 1 Original No 1	ORJINAL NO 1 Original No 2	EŞDEĞER NO 1 Equivalent No 1	EŞDEĞER NO 1 Equivalent No 2	ÖLÇÜLER MM. Dimensions - MM.					TİP Type	MALZEME Material
041127-H	TRANSIT V184	DİREKSİYON KUTUSU Steering Box	-	-	15019947	-	30,00	42,50		6,50		L3BT	HNBR
041228-HL	-	DİREKSİYON SİSTEMİ Steering System	-	-	-	-	30,00	42,50	49,00	7,40	10,90	SPL3BT	HNBR+TPU
040837	TRANSİT 15	HİDROLİK DİREKSİYON Steering Box	-	-	12015495	-	17,00	30,00		6,00		L3BTL	NBR
041120	FOCUS	HİDROLİK DİREKSİYON Steering Box	-	-	01019875	-	26,00	35,00		7,00		SPL3B	NBR

DİĞER ÜRÜNLER / Other Products

SKT NO	KULLANILAN MODELLER Models	KULLANIM YERİ Place Of Use	ORJINAL NO 1 Original No 1	ORJINAL NO 1 Original No 2	EŞDEĞER NO 1 Equivalent No 1	EŞDEĞER NO 1 Equivalent No 2	ÖLÇÜLER MM. Dimensions - MM.					TİP Type	MALZEME Material
4B1-002-T	TRANSİT T12 - T15	ÖN AMORTİSÖR TAKOZU Front Shock Absorber Mount	92VB 3K155 AD	-	-	-	Ön Amortisör Üst						
4B1-209-T	TRANSİT SERİSİ (V-184, V-347, V-348, V-362, V-363)	ŞAFT ASKISI 30 MM. Drive Shaft Center Supp. Bear.	YC1W 4826 AA	CC11 4826 AA	-	80000568	Merkezden Kaçık Tip İç Çap 30 MM. Rulmanlı						
4B1-214-T	TRANSİT SERİSİ (V347, 3.2MOTOR, 200PS 2006=>) -	ŞAFT ASKISI 35 MM. Drive Shaft Center Supp. Bear.	8C11 4826 AA	1510905	-	-	Merkezden Kaçık Tip İç Çap 35 mm. Rulmanlı						

MOTOR GRUBU / Engine Group

SKT NO	KULLANILAN MODELLER Models	KULLANIM YERİ Place Of Use	ORJINAL NO 1 Original No 1	ORJINAL NO 2 Original No 2	EŞDEĞER NO 1 Equivalent No 1	EŞDEĞER NO 2 Equivalent No 2	ÖLÇÜLER MM. Dimensions - MM.				TİP Type	MALZEME Material	
041277-V	ACCORD-CIVIC-CRX	KRANK ÖN Crank Shaft Front	91212P01003	91912P7A004	19026198	-	31,00	46,00		7,00		L3L SOL -Left	FKM
040329-S	ACCORD-CIVIC-JAZZ	KRANK ÖN Crank Shaft Front	91212611003	91212611004	19016483 12011666	580.988	35,00	50,00		8,00		L3 SAĞ -Right	VMQ
046249-V	CIVIC-CITY-INTEGRA-CRW-CRX 1.4-1.6-2.0 =>2005	KRANK ÖN Crank Shaft Front	91212PLC004	91212PLMA01	19026115	19026210	38,00	50,00		7,40		SPL3L SOL-Left	FKM
046231-V	ACCORD-CIVIC-CR-V-S2000	KRANK ÖN Crank Shaft Front	91212RBDE01	91212RBDE02	01020045	466.042	43,00	58,00		7,00		L13TL SAĞ -Right	FKM
047681-V	CIVIC-ACCORD-CRV-JAZZ 1.6 2005=>	KRANK ARKA Crank Shaft Rear	91214P8AA01	91214PH7003	19016570	590.797	80,00	98,00		10,00		L13L SOL -Left	FKM
410453-V	CIVIC II 2.0	KRANK ARKA Crank Shaft Rear	-	-	20018713	508.926	93,00	108,00		7,00		L3TL SOL -Left	FKM
041061-V	ACCORD-CIVIC-CRX-PROLUDE	EKSANTRİK MİLİ Cam Shaft	91203611004	91203611000	19016482	591.777	27,00	43,00		9,00		L3TL SOL -Left	FKM
041280-V	ACCORD-CIVIC-CRX-HR-V-INTEGRA- PROLUDE	EKSANTRİK MİLİ Cam Shaft	91213PC6000	91213PE1721	19016486 19027823	012.160	29,00	45,00		8,00		L3TL SOL -Left	FKM
040831-V	LEGEND 2.5-2.7	EKSANTRİK MİLİ Cam Shaft	2214421010	2214435000	19016568	293.946	35,00	50,00		8,00		L13TL SAĞ -Right	FKM
45-073-V	CIVIC-ACCORD-CRX-CAZZ-HRV-CRV 1.3-1.4-1.6-2.0-2.2 MOT.	SUPAP Valve Stem Seal	12210P45G01	12210PJ7003	12020308 49472920	130.560	5,50	11,00	12,80	9,90		LSY	FKM

DİFERANSİYEL GRUBU / Differential Group

SKT NO	KULLANILAN MODELLER Models	KULLANIM YERİ Place Of Use	ORJINAL NO 1 Original No 1	ORJINAL NO 2 Original No 2	EŞDEĞER NO 1 Equivalent No 1	EŞDEĞER NO 2 Equivalent No 2	ÖLÇÜLER MM. Dimensions - MM.				TİP Type	MALZEME Material	
046248-P	CIVIC-ACCORD-CRX	DİFERANSİYEL SAĞ ÇIKIŞ Dif.-Right/Left Output	91206PL3A01	91206PL3A02	19019971	82019971	35,00	62,00		8,00	11,50	L3LR SAĞ -Right	ACM

ŞANZİMAN GRUBU / Gearbox Group

SKT NO	KULLANILAN MODELLER Models	KULLANIM YERİ Place Of Use	ORJINAL NO 1 Original No 1	ORJINAL NO 2 Original No 2	EŞDEĞER NO 1 Equivalent No 1	EŞDEĞER NO 2 Equivalent No 2	ÖLÇÜLER MM. Dimensions - MM.				TİP Type	MALZEME Material	
041299-P	CIVIC-ACCORD- 1.3-1.4-1.5-1.6 BENZİNLİ =>2005	ŞANZİMAN ÖN Gearbox Front	91216PL3000	91216PL3003	19026199	NK137	26,00	42,00		7,00		L3L SOL -Left	ACM
041168-P	ACCORD-CRX-INTEGRA-PROLUDE	ŞANZİMAN ÖN Gearbox Front	91216PC8003	91216PC8005	12015750	-	27,00	42,00		6,00		L3TL SAĞ -Right	ACM
046231-V	ACCORD-CIVIC-CR-V-S2000	ŞANZİMAN ÖN Gearbox Front	91212RBDE01	91212RBDE02	01020045	466.042	43,00	58,00		7,00		L13TL SAĞ -Right	FKM

MOTOR GRUBU / Engine Group

SKT NO	KULLANILAN MODELLER Models	KULLANIM YERİ Place Of Use	ORJINAL NO 1 Original No 1	ORJINAL NO 2 Original No 2	EŞDEĞER NO 1 Equivalent No 1	EŞDEĞER NO 2 Equivalent No 2	ÖLÇÜLER MM. Dimensions - MM.				TİP Type	MALZEME Material
040944-V	MATRIX 1.5 CRDI	KRANK ÖN Crank Shaft Front	5646262	7628850	12018321	069.590	31,00	41,00		7,00	L13TL SAĞ -Right	FKM
041263-V	ELENTA-GETZ-İ30-TUSCON-SONATA-SANTA FE-MATRIX-ACCENT 1.5 CRDI	KRANK ÖN Crank Shaft Front	2133527000	-	19036883	583.050	32,00	45,00		6,00	L3L SAĞ -Right	FKM
041304-V	İ10-İ20 1.0-1.2-1.25-1.4 BENZİNLİ-ACCENT BLUE-GETZ-KONA	KRANK ÖN-YAĞ POMPASI Crank Shaft Front-Oil Pump	2142103000	2142103000	-	355.700	34,00	48,00		7,00	L3TL SAĞ -Right	FKM
040830-V	ACCENT-ELENTA-GETZ 1.3-1.4-1.6	KRANK ÖN Crank Shaft Front	2142122001	2142122000	12016300	702269 090970	35,00	48,00		8,00	L13TL SAĞ -Right	FKM
041305-V	ELENTA-MATRIX-TUCSON-İ30 1.4-2.0 BENZİNLİ	KRANK ÖN Crank Shaft Front	2142123000	2142123020	49426271 49434499	434.860	37,60	49,00		7,50	L3TL SAĞ -Right	FKM
045997-V	IX35-İ40-SONATA-ELENTA	KRANK ÖN Crank Shaft Front	214212E000	214212E300	12015430	854.180	40,00	52,00		6,00	L3L SAĞ -Right	FKM
046161-V	ACCENT-GETZ-SANTA FE 1.5 CRDI	KRANK ÖN Crank Shaft Front	213612A100	4311921010	19034959	351.180 717.710	41,00	53,00		6,00	L3L SAĞ -Right	FKM
045968-V	ELANTRA 1.9D-H100 2.5D	KRANK ÖN Crank Shaft Front	2172929000	9616201580	20015456	508.233 040.363	42,00	62,00		7,00	L13TL SAĞ -Right	FKM
045792-P	H100-SANTAFE-SONATO	KRANK ÖN Crank Shaft Front	2132142031	2142133114	19027863 19027863	247.280	44,00	60,00		7,00	L3L SAĞ -Right	ACM
045922-V	H100-ELENTA-SANTA FE-SONATA- H1 STAREX 2.5 TD	KRANK ÖN Crank Shaft Front	2142133114	2142132014	19027863 19012585	247.280	44,00	60,00		7,00	L13TL SAĞ -Right	FKM
047704-V	ACCENT-ELENTA-GETZ	KRANK ARKA Crank Shaft Rear	2144322000	2144321010	19027853	034.530	72,00	96,00		9,00	L13TL SOL -Left	FKM
047912-V	İ10 1.25-İ20-ACCENT-ICONIC-KONA-BAYON-İ30 1.0-1.2-1.25- İ20 -BENZİNLİ	KRANK ARKA Crank Shaft Rear	21443-03010	2144303011	-	353.010	72,00	98,00		8,00	L3TL SOL -Left	FKM
410504-V	ACCENT-ELENTA-İ20-İ30-İ40-İX20-İX35-TUCSON 1.4-1.6 BENZİNLİ	KRANK ARKA Crank Shaft Rear	214432B000	214432B010	49372492	318.360	76,00	108,00		8,00	L3TL SOL -Left	FKM
047705-V	H100-ELENTA-SONATA-H1 STAREX 2.5 TD	KRANK ARKA Crank Shaft Rear	2132142041	2144332000	19016236	815332210	80,00	96,00		9,00	L13TL SOL -Left	FKM
410382-V	ELANTRA-H100	KRANK ARKA Crank Shaft Rear	012728	9614379380	20015455	508.209	90,00	110,00		7,00	L3TL SOL -Left	FKM
410456-V	ACCENT-ELENTA-GETZ-SANTAFE-SONATA 1.5 CRDI	KRANK ARKA Crank Shaft Rear	214432A000	-	19027858 19016595	NA5140	91,00	111,00		9,00	L3L SOL -Left	FKM
040789-V	SONATA	EKSANTRİK MİLİ Cam Shaft	2214435504	2214439000	12011839	505.838	30,00	42,00		7,00	L3T SAĞ -Right	FKM
041303-V	ACCENT III	EKSANTRİK MİLİ Cam Shaft	-	-	20031720	056.900 81-35147-00	31,50	42,00		7,00	L13TL SAĞ -Right	FKM

MOTOR GRUBU / Engine Group

SKT NO	KULLANILAN MODELLER Models	KULLANIM YERİ Place Of Use	ORJINAL NO 1 Original No 1	ORJINAL NO 1 Original No 2	EŞDEĞER NO 1 Equivalent No 1	EŞDEĞER NO 1 Equivalent No 2	ÖLÇÜLER MM. Dimensions - MM.				TİP Type	MALZEME Material	
040831-V	H100-STAREX-ACCENT-ELENTA-GETZ-SANTA FE-SONATA 2.5 TD	EKSANTRİK MİLİ Cam Shaft	2214421010	2214433004	19016568	293.946	35,00	50,00		8,00		L13TL SAĞ -Right	FKM
041287-V	ACCENT-ELENTA-GETZ-İ30-MATRIX-SANTA FE-TUCSON 2.0 CRDI	EKSANTRİK MİLİ Cam Shaft	2214427000	-	20015457 07022633	505.366	36,00	50,00		7,00		L3TL SAĞ -Right	FKM
040833-V	H100-STAREX 2.5 TD	BALANS MİLİ-KÜÇÜK Eng. Damper Shaft	2132142021	MD069948	19020127	19016594	17,00	28,00		7,00		L13TL SAĞ -Right	FKM
040832-V	H100-ELENTA-SANTA FE-SONATA 2.5 TD	BALANS MİLİ-BÜYÜK Eng. Damper Shaft	2142133134	2132142011	19020128	15004400	25,00	35,00		6,00		L13TL SAĞ -Right	FKM
45-080-V	İ20-İ30-İX20-İX35-ACCENT ERA-BLUE-GETZ-1.4,1.5,1.6 CRDI	SUPAP Valve Stem Seal	22224-2A000	22224-2A200	19036815	333.120	5,00	8,60	21,50	15,70		LSY5	FKM
45-022-V	ACCENT-ELENTA-GETZ-SONATA	SUPAP Valve Stem Seal	2222423500	9091302090	19027767 19018204	49472839	5,50	11,00	13,50	6,50	10,15	LSYT	FKM
45-033-V	OTOMOBİL	SUPAP Valve Stem Seal	OK55110155	-	12015802 49472012	701.289 70-26058-00	7,00	9,80	13,20	10,00		LSY2T	FKM
45-029-V	H100-STAREX-SONATA 2.5 TD	SUPAP Valve Stem Seal	2222435000	MD000508	19019230	010.270	8,00	13,00	15,35	9,00	13,25	LSY	FKM
45-078-V	İ10-İ20-İ30-ATOS-ELENTA-İX20-İX35-ACCENT 1.2/1.25/1.4 -	SUPAP EMME-EKSOZ Valve Intake-Exhaust	22224-2B011 22224-2B000	22224-2B010 22224-2B001	19037069 19037070	-	5,50	10,00	12,80	12,00		LSY	FKM

AKS GRUBU / Axle Group

SKT NO	KULLANILAN MODELLER Models	KULLANIM YERİ Place Of Use	ORJINAL NO 1 Original No 1	ORJINAL NO 1 Original No 2	EŞDEĞER NO 1 Equivalent No 1	EŞDEĞER NO 1 Equivalent No 2	ÖLÇÜLER MM. Dimensions - MM.				TİP Type	MALZEME Material	
045731	H100	ÖN AKS Front Axle	5183044000	5170144030	19019080	041.114	50,00	65,00		8,00		L1L	NBR
045919	ACCENT	ÖN AKS İÇ-DIŞ Front Axle Inner-Outer	5171321100	5171221100	FR940595	J4700501	50,00	66,50		13,00	16,00	L3TLR	NBR
047578	HD 35	ÖN AKS Front Axle	5183045000	-	-	-	68,00	90,00		12,00		L1L	NBR
046100-P	ACCENT	ARKA AKS Rear Axle	4311939020	-	-	-	41,00	61,00		8,10	12,90	SPSL1	ACM
047869	STAREX (H-1)	ARKA AKS Rear Axle	5282047000	-	-	-	42,00	82,00		10,50		SPL3T	NBR
046131	-	ARKA AKS Rear Axle	N38082	281501317	12013928	16018444	55,00	70,00		8,00		L3LL SS- RL	NBR

AKS GRUBU / Axle Group

SKT NO	KULLANILAN MODELLER Models	KULLANIM YERİ Place Of Use	ORJINAL NO 1 Original No 1	ORJINAL NO 1 Original No 2	EŞDEĞER NO 1 Equivalent No 1	EŞDEĞER NO 1 Equivalent No 2	ÖLÇÜLER MM. Dimensions - MM.					TİP Type	MALZEME Material
041149	STAREX (H-1)	ARKA AKS PORYA DIŞ Rear Axle Outer	5282044500	-	-	-	33,00	40,00		3,50	6,50	L3C	NBR
045989	H100	ARKA AKS PORYA DIŞ Rear Axle Outer	528204B100	-	-	-	39,00	76,50		10,50	14,00	SPL3	NBR
045120	SANTA FE	ARKA AKS PORYA DIŞ Rear Axle Outer	5305039000	-	12011460	706.035	42,00	65,00		10,00	12,00	L3L	NBR
045923	H100	ARKA AKS PORYA DIŞ Rear Axle Outer	5282043300	5270143300	FR911743	J4710508	47,70	73,61		9,50	12,00	SPL13TL	NBR
046015	STAREX	ARKA AKS PORYA DIŞ Rear Axle Outer	52820 4A 060	-	-	-	50,00	75,00	-	10,00	-	L1L	NBR
410454	HD 75-78	ARKA AKS PORYA DIŞ Rear Axle Outer	5282045210	-	-	-	52,00	112,00		10,50	15,50	SPL3	NBR
410440-P	HD 35	ARKA AKS PORYA DIŞ Rear Axle Outer	528205K810	-	-	-	57,00	101,00		17,80	22,00	SPL3L	ACM
045924	H100	ARKA AKS PORYA İÇ Rear Axle Inner	5281043000	5270143300	19019539	-	35,00	58,00		10,00		SPL3T	NBR
045988	H100	ARKA AKS PORYA İÇ Rear Axle Inner	5281044000	-	-	-	58,00	75,00		9,00		L1L	NBR
047842	H100	ARKA AKS PORYA İÇ Rear Axle Inner	528104F400	-	-	-	62,00	82,00		9,00		L1L	NBR
047841	STAREX (H-1)	ARKA AKS PORYA İÇ Rear Axle Inner	5281044500	-	-	-	65,00	92,00		13,00		L1L	NBR
410455	HD 75-78	ARKA AKS PORYA İÇ Rear Axle Inner	528105K000	-	-	-	80,00	122,00		10,00	18,00	L1L	NBR
410439-V	HD 35	ARKA AKS PORYA İÇ Rear Axle Inner	528105K800	-	-	-	95,00	125,00		10,00		L3L SS- RL	FKM

DİFERANSİYEL GRUBU / Differential Group

SKT NO	KULLANILAN MODELLER Models	KULLANIM YERİ Place Of Use	ORJINAL NO 1 Original No 1	ORJINAL NO 1 Original No 2	EŞDEĞER NO 1 Equivalent No 1	EŞDEĞER NO 1 Equivalent No 2	ÖLÇÜLER MM. Dimensions - MM.					TİP Type	MALZEME Material
045940-P	H100	DİFERANSİYEL ÖN-MAHRUTİ Differential Front-Bevelgear	5335243000	5305039000	12011460 12013479	706.035	42,00	65,00		11,00		L1L SAĞ -Right	ACM
045939-P	H100	DİFERANSİYEL ÖN-MAHRUTİ Differential Front-Bevelgear	5335244000	-	19016663	NJ739	45,00	72,00		12,00	19,50	L1LR SAĞ -Right	ACM

DİFERANSİYEL GRUBU / Differential Group

SKT NO	KULLANILAN MODELLER Models	KULLANIM YERİ Place Of Use	ORJINAL NO 1 Original No 1	ORJINAL NO 2 Original No 2	EŞDEĞER NO 1 Equivalent No 1	EŞDEĞER NO 2 Equivalent No 2	ÖLÇÜLER MM. Dimensions - MM.					TİP Type	MALZEME Material
046262-P	HYUNDAI SANTRO, ACCENT, İ10, İ20, GETZ, ELANTRA-İ10-1.0 - İ20 1.2 BENZİNLİ	DİFERANSİYEL SAĞ ÇIKIŞ Dif.-Right/Left Output	4311928010	4311928070	-	-	35,00	56,00	62,00	9,00	11,40	SPL1L SAĞ-Right	ACM
046266-P	ELANTRA GT, SANTA FE, SONATA, SORENTO-TUCSON İ30 1.6 CRDI- OTM.ŞANZ.	DİFERANSİYEL SAĞ ÇIKIŞ Dif.-Right/Left Output	452453B310	-	-	-	37,00	67,00		10,00	17,00	SPL3LR SAĞ-Right	ACM
046266-P	CERATO-SPORTAGE 16 CRDI MOT. OTM. ŞANZ.	DİFERANSİYEL SAĞ ÇIKIŞ Dif.-Right/Left Output	452453B310	-	-	-	37,00	67,00		10,00	17,00	SPL3LR SAĞ-Right	ACM
046265-P	ACCENT-GETZ-İ20-İ30-1.4-1.6-2.0 BENZ./1.5 CRDI	DİFERANSİYEL SAĞ ÇIKIŞ Dif.-Right Output	4311939020	-	-	-	39,30	61,30		7,50	12,80	SPL1L SAĞ-Right	ACM
046269-P	ACCENT 1.6 CRDI-İ20-ELANTRA-GT, TUCSON, 1.4 BENZ	DİFERANSİYEL SAĞ ÇIKIŞ Dif.-Right Output	4311939070	-	-	-	41,00	61,00	68,00	8,10	12,90	SPL1L SAĞ-Right	ACM
046267-P	HYUNDAI, ACCENT, İ10, İ20, XCENT, GETZ, ELANTRA-İ10-1.0 - İ20 1.2 BENZİNLİ	DİFERANSİYEL SOL ÇIKIŞ Differential Left Output	4311928020	4311928080	-	-	35,00	56,00	62,00	9,00	11,40	SPL1L SOL-Left	ACM
046264-P	ACCENT, ELANTRA, TUCSON- ACCENT-İX20-İX35-İ20-İ30 1.5-1.6-2.0 CRDI	DİFERANSİYEL SOL ÇIKIŞ Differential Left Output	43119-39080	43119-39060	-	-	41,00	61,00	68,00	8,10	12,90	SPL1LL SOL-Left	ACM
045920-P	ACCENT-ELENTRA-GETZ-MATRIX-SONATA	DİFERANSİYEL SAĞ-SOL ÇIKIŞ Dif.-Right/Left Output	4311928001	91206PE6004	49440628	-	35,00	56,00		7,50	11,50	L3TLR SS- RL	ACM
046160-P	ACCENT-ELENTRA-SONATA	DİFERANSİYEL SAĞ-SOL ÇIKIŞ Dif.-Right/Left Output	4311928000	53351M2000	19016578	NJ452	35,00	56,00		9,00	14,80	L3LR	ACM

ŞANZİMAN GRUBU / Gearbox Group

SKT NO	KULLANILAN MODELLER Models	KULLANIM YERİ Place Of Use	ORJINAL NO 1 Original No 1	ORJINAL NO 2 Original No 2	EŞDEĞER NO 1 Equivalent No 1	EŞDEĞER NO 2 Equivalent No 2	ÖLÇÜLER MM. Dimensions - MM.					TİP Type	MALZEME Material
040588-P	ACCENT-ELENTRA-SANAYİ-GETZ 1.3-1.4-1.6-1.5 CRDI	ŞANZİMAN ÖN Gearbox Front	4313434000	2142132030	19027874	19016660	25,00	35,00		6,00		L3L SAĞ -Right	ACM
041306-P	İ10-İ20-İ30-İX20-İX35-TUCSON-GETZ-SO-NATA-ELENTRA-ACCENT 1.6 CRDI	ŞANZİMAN ÖN Gearbox Front	4313439011	4313434000	19027874 19027874	247.260	25,00	35,00		6,00		SPL3L SAĞ-Right	ACM
040829-P	H100-SANTA FE-H1 STAREX 2.5-SONATA-GALLOPER	ŞANZİMAN ÖN Gearbox Front	4314333000	431434A001	19027850	-	30,00	45,00		6,00		L12L SAĞ -Right	ACM
040877-P	HD 35/75	ŞANZİMAN ÖN Gearbox Front	4311345100	-	-	-	34,00	50,00		7,00		L3L SAĞ -Right	ACM
045921-P	H100	ŞANZİMAN ARKA Gearbox Rear	4315644000	-	19015088	NJ612	36,00	52,00		10,00		L3TL SOL -Left	ACM
046263-P	ELANTRA GT, KONA, SANTA FE, SONATA, SORENTO-TUCSON-İ30-1.6 CRDI	ŞANZİMAN ARKA Gearbox Rear	452453B410	452453B410	-	-	37,00	64,00		10,00	17,00	SPL3LR SOL-Left	ACM

ŞANZIMAN GRUBU / Gearbox Group

SKT NO	KULLANILAN MODELLER Models	KULLANIM YERİ Place Of Use	ORJINAL NO 1 Original No 1	ORJINAL NO 1 Original No 2	EŞDEĞER NO 1 Equivalent No 1	EŞDEĞER NO 1 Equivalent No 2	ÖLÇÜLER MM. Dimensions - MM.				TİP Type	MALZEME Material	
046127-P	H100	ŞANZIMAN ARKA Gearbox Rear	431564A001	-	-	-	39,60	52,00		10,00		L3L SOL -Left	ACM
046125-P	HD 35	ŞANZIMAN ARKA Gearbox Rear	4315645100	-	-	-	48,00	65,00		9,00		L3L	ACM
041146-P	HD 75	ŞANZIMAN MİLİ İÇ Gearbox Shaft Inner	4347945100	-	-	-	13,00	22,00		5,00		L3L	ACM
041145-P	HD 75	ŞANZIMAN MİLİ İÇ Gearbox Shaft Inner	434805H000	-	-	-	23,00	33,00		5,00		L3L	ACM
4D-415-H	HD 35	ŞANZIMAN MİLİ DIŞ Gearbox Shaft Outer	4346469000	-	-	-	25,85	45,37		9,00		MH	HNBR
041152	OTOMOBİL	VİTES SEÇİCİ MİLİ Gear Selection Shaft	-	-	16018445	-	16,00	28,00		7,00	6,00	L3L SS-RL	NBR
040872	SANTA FE 2.0 CRDI-2.4 16V	ARAZİ ŞANZIMANI 4x4 Transfer Box 4x3	4735239000	4735239010	12010895	NF072	32,00	47,00		7,00		L3TL	NBR
040711-P	JEEP SERİSİ	ARAZİ ŞANZIMANI 4x4 Transfer Box 4x4	MD701430	-	19016661	-	32,00	48,00		10,00		L3L SOL -Left	ACM

DİREKSİYON GRUBU / Steering Group

SKT NO	KULLANILAN MODELLER Models	KULLANIM YERİ Place Of Use	ORJINAL NO 1 Original No 1	ORJINAL NO 1 Original No 2	EŞDEĞER NO 1 Equivalent No 1	EŞDEĞER NO 1 Equivalent No 2	ÖLÇÜLER MM. Dimensions - MM.				TİP Type	MALZEME Material	
041132-V	ACCENT-GETZ	DİREKSİYON POMPA Steering Pump	077008434	-	15020025	-	19,00	32,00		7,00		L3BTL	FKM
041128	ACCENT	DİREKSİYON KUTUSU Steering Box	-	-	12012050	-	23,00	34,30		6,35		L3B	NBR
040930-NL	OTOMOBİL SERİSİ	DİREKSİYON SİSTEMİ Steering System	12340591	-	19020602	-	24,00	36,50		7,50		SPL3B	NBR+TPU
041202-H	OTOMOBİL SERİSİ	DİREKSİYON SİSTEMİ Steering System	12340591	-	19020602	-	24,00	36,50		8,50		L3B	HNBR
041227-NL	OTOMOBİL SERİSİ	DİREKSİYON SİSTEMİ Steering System	-	-	-	-	27,70	42,00	-	8,50	-	SPL3B	NBR+TPU

MOTOR GRUBU / Engine Group

SKT NO	KULLANILAN MODELLER Models	KULLANIM YERİ Place Of Use	ORJINAL NO 1 Original No 1	ORJINAL NO 2 Original No 2	EŞDEĞER NO 1 Equivalent No 1	EŞDEĞER NO 2 Equivalent No 2	ÖLÇÜLER MM. Dimensions - MM.				TİP Type	MALZEME Material	
046219-FP	DAILY 3.0 MOT.	KRANK ÖN Crank Shaft Front	504056152	504274032	20034876	353.780	50,00	70,00		11,00	SPFPT2K SAĞ-Right	PTFE+ACM	
047905-FPL	DAILY 2.3 JTD	KRANK ÖN Crank Shaft Front	504087648	504227240	20034613	749.250	50,00	80,00		11,00	SPFT SAĞ-Right	PTFE+ ACM+TPU	
047898-V	DAILY 2.3 JTD MOT.	KRANK ÖN Crank Shaft Front	504014155	504123772	12019748	431.110	50,00	80,00		14,00	SC ETS1	FKM	
417107-V	DAILY 35 C11-C13-C15	KRANK ÖN Crank Shaft Front	504086312	503646256	12016918	199.220	70,00	158,00	180,00	16,00	SPL1L SAĞ-Right	FKM	
410493-V	DAILY 2.3 JTD MOT.	KRANK ARKA Crank Shaft Rear	504010779	504123771	12019602 12019825	431.120	83,00	113,00		13,00	12,20	SC ETS1	FKM
410500-V	DAILY 3,0 D	KRANK ARKA Crank Shaft Rear	504014232	504180969	12019863	353.090	90,00	120,00		12,50	13,00	SC ETS1	FKM
417108-V	DAILY 35 C11-C13-C15	KRANK ARKA Crank Shaft Rear	504086309	97301850	12016920	199.230	114,00	171,00	177,00	13,00		SPL1L SOL-Left	FKM
046218-V	DAILY 2.3 JTD MOT.	EKSANTRİK MİLİ Cam Shaft	500350049	-	12017215	375.470	34,00	60,00		10,00		L13TL SAĞ-Right	FKM
045990-V	DAILY 35 C11-C13-C15	EKSANTRİK MİLİ Cam Shaft	98454039	40100933	12014728	419.730	55,00	70,00		8,00		L13TL SAĞ-Right	FKM
45-061-V	DAILY 2.3-3.0 JTD MOT.	SUPAP Valve Stem Seal	095161	-	12019782 49472021	718.210	6,00	10,00	22,00	19,00		LSY5T	FKM
45-030-V	DAILY 2.8 MOT.	SUPAP Valve Stem Seal	4830224	401015730	12015512 49472894	143.930 104.380	8,00	12,00	15,20	5,70	9,50	LSY2T	FKM
45-051-V	DAILY 2.8 MOT.	SUPAP Valve Stem Seal	4830224	401015730	12015512 49472894	143.930 104.380	8,00	12,00	15,00	6,00	9,50	LSY2T	FKM
040760	DAILY-EM	YAKIT POMPASI-Bosch Tipi Fuel Pump-Bosch Type	93160144	-	12014600	82019584	20,00	31,00		7,00		L1B	NBR
040942-V	DAILY 35 C11-C13-C15	YAKIT POMPASI Fuel Pump	42530258	42551388	12019586	-	20,00	31,00		7,30		L13TL	FKM

AKS GRUBU / Axle Group

SKT NO	KULLANILAN MODELLER Models	KULLANIM YERİ Place Of Use	ORJINAL NO 1 Original No 1	ORJINAL NO 1 Original No 2	EŞDEĞER NO 1 Equivalent No 1	EŞDEĞER NO 1 Equivalent No 2	ÖLÇÜLER MM. Dimensions - MM.				TİP Type	MALZEME Material	
047739	DAILY 35 C11	ÖN AKS Front Axle	40379300	334617	12015943	663P	70,00	90,00		13,50		L1L	NBR
045991	DAILY 35 C11	ARKA AKS Rear Axle	1323192080	1306356080	12014086	-	58,00	75,00		14,00	15,50	L13TL	NBR

DİFERANSİYEL GRUBU / Differential Group

SKT NO	KULLANILAN MODELLER Models	KULLANIM YERİ Place Of Use	ORJINAL NO 1 Original No 1	ORJINAL NO 1 Original No 2	EŞDEĞER NO 1 Equivalent No 1	EŞDEĞER NO 1 Equivalent No 2	ÖLÇÜLER MM. Dimensions - MM.				TİP Type	MALZEME Material	
045995-V	DAILY 35 C11	DİFERANSİYEL SAĞ ÇIKIŞ Dif.-Right Output	301028	9616785780	07019090	381.710	34,90	54,00		11,30		L3TL SAĞ -Right	FKM
047909-VP	DAILY I-III SERİSİ	DİFERANSİYEL SAĞ ÇIKIŞ Dif.-Right Output	40102253	40102260 40102263	12015791	82015791	60,00	90,00		14,00	16,30	SCL13TL- SAĞ-Right	FKM+ACM
045994-V	DAILY 35 C11	DİFERANSİYEL SOL ÇIKIŞ Differential Left Output	9616785980	-	07019089	381.690	43,00	59,00		10,00		L3TL SOL -Left	FKM

73

ŞANZİMAN GRUBU / Gearbox Group

SKT NO	KULLANILAN MODELLER Models	KULLANIM YERİ Place Of Use	ORJINAL NO 1 Original No 1	ORJINAL NO 1 Original No 2	EŞDEĞER NO 1 Equivalent No 1	EŞDEĞER NO 1 Equivalent No 2	ÖLÇÜLER MM. Dimensions - MM.				TİP Type	MALZEME Material	
046087-V	DAILY 35 C11	ŞANZİMAN ÖN Gearbox Front	40102763	40102760	12029812	-	35,00	64,00		9,00		L13TL SAĞ -Right	FKM
046086-V	DAILY 35 C11	ŞANZİMAN ARKA Gearbox Rear	40102773	40102770	12029813	-	40,00	52,00		9,00		L13TL SOL -Left	FKM

DİREKSİYON GRUBU / Steering Group

SKT NO	KULLANILAN MODELLER Models	KULLANIM YERİ Place Of Use	ORJINAL NO 1 Original No 1	ORJINAL NO 1 Original No 2	EŞDEĞER NO 1 Equivalent No 1	EŞDEĞER NO 1 Equivalent No 2	ÖLÇÜLER MM. Dimensions - MM.				TİP Type	MALZEME Material	
040820	EM ZF 8033 TİP.KUTU	DİREKSİYON KUTUSU Steering Box	42550913	-	12016820	-	20,00	30,00		7,00	8,00	L3BTL	NBR
040694	DAILY SERİSİ-EM	DİREKSİYON SİSTEMİ Steering System	9918917	-	-	-	35,00	47,00		7,00		L3BTL	NBR

MOTOR GRUBU / Engine Group

SKT NO	KULLANILAN MODELLER Models	KULLANIM YERİ Place Of Use	ORJINAL NO 1 Original No 1	ORJINAL NO 2 Original No 2	EŞDEĞER NO 1 Equivalent No 1	EŞDEĞER NO 2 Equivalent No 2	ÖLÇÜLER MM. Dimensions - MM.				TİP Type	MALZEME Material	
047898-V	JEST 2.3 JTD MOT.	KRANK ÖN Crank Shaft Front	504014155	504123772	12019748	431.110	50,00	80,00		14,00		SC ETS1	FKM
046239-VK	PREMIER - ISUZU 2.2 MOT.	KRANK ÖN Crank Shaft Front	10332881	-	19033958	933.180	50,00	68,00		9,00		SPL3K SAĞ-Right	FKM+YÜN
410493-V	JEST 2.3 JTD MOT.	KRANK ARKA Crank Shaft Rear	504010779	504123771	12019602 12019825	431.120	83,00	113,00		13,00	12,20	SC ETS1	FKM
410499-VK	PREMIER - ISUZU 2.2 MOT.	KRANK ARKA Crank Shaft Rear	8970715611	-	19019103	454.060	95,00	118,00		9,5	13,00	SC ETS1	FKM+YÜN
046218-V	JEST 2.3 JTD MOT.	EKSANTRİK MİLİ Cam Shaft	500350049	-	12017215	375.470	34,00	60,00		10,00		L13TL SAĞ -Right	FKM
45-061-V	JEST 2.3-3.0 JTD MOT.	SUPAP Valve Stem Seal	095161	-	12019782 49472021	718.210	6,00	10	22,00	19,00		LSY5T	FKM

AKS GRUBU / Axle Group

SKT NO	KULLANILAN MODELLER Models	KULLANIM YERİ Place Of Use	ORJINAL NO 1 Original No 1	ORJINAL NO 2 Original No 2	EŞDEĞER NO 1 Equivalent No 1	EŞDEĞER NO 2 Equivalent No 2	ÖLÇÜLER MM. Dimensions - MM.				TİP Type	MALZEME Material	
047740	PREMIER	ÖN AKS Front Axle	-	-	12017075	-	75,00	95,00		8,00		L3	NBR

DİFERANSİYEL GRUBU / Differential Group

SKT NO	KULLANILAN MODELLER Models	KULLANIM YERİ Place Of Use	ORJINAL NO 1 Original No 1	ORJINAL NO 2 Original No 2	EŞDEĞER NO 1 Equivalent No 1	EŞDEĞER NO 2 Equivalent No 2	ÖLÇÜLER MM. Dimensions - MM.				TİP Type	MALZEME Material	
046131	PREMIER	DİFERANSİYEL ÇIKIŞ Differential Output	-	-	12013928	16018444	55,00	70,00		8,00		L3LL SS- RL	NBR
045884-V	JEST	DİFERANSİYEL SAĞ ÇIKIŞ Dif.-Right/Left Output	-	-	01033292	-	35,00	54,90	61,00	9,00	14,70	SPL1L SS- RL	FKM

MOTOR GRUBU / Engine Group

SKT NO	KULLANILAN MODELLER Models	KULLANIM YERİ Place Of Use	ORJINAL NO 1 Original No 1	ORJINAL NO 2 Original No 2	EŞDEĞER NO 1 Equivalent No 1	EŞDEĞER NO 2 Equivalent No 2	ÖLÇÜLER MM. Dimensions - MM.				TİP Type	MALZEME Material
040944-V	CEED 1.5 CRDI	KRANK ÖN Crank Shaft Front	5646262	7628850	12018321	069.590	31,00	41,00		7,00	L13TL SAĞ -Right	FKM
040911-P	BESTA	KRANK ÖN Crank Shaft Front	OFE0110602	-	12011842	022.170	34,00	48,00		7,00	L3L SAĞ -Right	ACM
041304-V	PICANTO-RIO-CEED 1.0-1.2-1.25-1.4 BENZİNLİ	KRANK ÖN-YAĞ POMPASI Crank Shaft Front-Oil Pump	2142103000	2142103000	-	355.700	34,00	48,00		7,00	L3TL SAĞ -Right	FKM
041114-V	BESTA-BONGO	KRANK ÖN Crank Shaft Front	7700273776	-	20019851	504.483	35,00	47,00		6,00	L3TL SAĞ -Right	FKM
046175-V	PRIDE-SEPHIA	KRANK ÖN Crank Shaft Front	M13XF10602A	-	19025980	-	36,50	50,50		7,00	L3TL SAĞ -Right	FKM
041305-V	PRO CEED-SPORTAGE-CERATO-CARENS 1.4-2.0 BENZİNLİ	KRANK ÖN Crank Shaft Front	2142123000	2142123020	49426271 49434499	434.860	37,60	49,00		7,50	L3TL SAĞ -Right	FKM
045997-V	SPORTAGE-OPTIMA-CARENS	KRANK ÖN Crank Shaft Front	214212E000	214212E300	12015430	854.180	40,00	52,00		6,00	L3L SAĞ -Right	FKM
045792-P	K2500-BONGO-PREGIO	KRANK ÖN Crank Shaft Front	MD174462	MD343563	19027863 19027863	247.280	44,00	60,00		7,00	L3L SAĞ -Right	ACM
045981-P	CERES 2.2	KRANK ÖN Crank Shaft Front	063610602	50015850	15026000	-	50,80	69,85		11,00	L3L SAĞ -Right	ACM
045980-P	BESTA-BONGO 2.7	KRANK ÖN Crank Shaft Front	3596216	VS0110602	19033844	NA5197	53,00	69,85		11,00	L3L SAĞ -Right	ACM
047704-V	RIO II	KRANK ARKA Crank Shaft Rear	2144322000	2144321010	19027853	034.530	72,00	96,00		9,00	L13TL SOL -Left	FKM
047912-V	PICANTO-RIA-CEED 1.0-1.2-1.25-1.4-1.6 BENZİNLİ	KRANK ARKA Crank Shaft Rear	21443-03010	2144303011	-	353.010	72,00	98,00		8,00	L3TL SOL -Left	FKM
410504-V	SPORTAGE-CARENS-CEED-CERATO- SOUL-1.4-1.6 BENZ.MOT.	KRANK ARKA Crank Shaft Rear	214432B000	214432B010	49372492	318.360	76,00	108,00		8,00	L3TL SOL -Left	FKM
047705-V	CEED-K2500-PREGIO-SPORTAGE	KRANK ARKA Crank Shaft Rear	2132142041	2144332000	19016236	815332210	80,00	96,00		9,00	L13TL SOL -Left	FKM
047877-V	PRIDE-SEPHIA	KRANK ARKA Crank Shaft Rear	M13XF11312	-	19016503	-	83,00	100,00		9,00	L3TL SOL -Left	FKM
410341-V	BESTA-BONGO	KRANK ARKA Crank Shaft Rear	OF80211399	12152257	12012579	702.994 311.898	90,00	110,00		12,00	L13TL SOL -Left	FKM
410385-V	CERES-BONGO 2.7	KRANK ARKA Crank Shaft Rear	OVS01-11-399	-	-	-	101,57	125,00		13,00	L3L SOL -Left	FKM
040693-V	-	EKSANTRİK MİLİ Cam Shaft	-	-	12014403	508.489	30,00	40,00		7,00	L3T SAĞ -Right	FKM

MOTOR GRUBU / Engine Group

SKT NO	KULLANILAN MODELLER Models	KULLANIM YERİ Place Of Use	ORJINAL NO 1 Original No 1	ORJINAL NO 1 Original No 2	EŞDEĞER NO 1 Equivalent No 1	EŞDEĞER NO 1 Equivalent No 2	ÖLÇÜLER MM. Dimensions - MM.					TİP Type	MALZEME Material
040910-P	BESTA-PRIDE-SEPHIA-CERES 2.2	EKSANTRİK MİLİ Cam Shaft	KKY0112602	KKY0110602	19026018	022.160	30,00	44,00		7,00		L3L SAĞ -Right	ACM
041287-V	CARENS-CERATO-SPORTAGE	EKSANTRİK MİLİ Cam Shaft	2214427000	-	20015457 07022633	505.366	36,00	50,00		7,00		L3TL SAĞ -Right	FKM
45-080-V	CEED-CERATO-RIO-	SUPAP Valve Stem Seal	22224-2A100	22224-2A200	19036815	333.120	5,00	8,60	21,50	15,70		LSY6	FKM
45-078-V	CEED-CERATO 1.6	SUPAP EMME-EKSOZ Valve Intake-Exhaust	22224-2B011 22224-2B000	22224-2B010 22224-2B001	19037069 19037070	-	5,50	10,00	12,80	12,00		LSY	FKM
45-054-V	PRIDE	SUPAP Valve Stem Seal	M13XF-10-155	-	-	-	7,00	12,00	14,50	8,70	13,00	LSY6T	FKM

AKS GRUBU / Axle Group

SKT NO	KULLANILAN MODELLER Models	KULLANIM YERİ Place Of Use	ORJINAL NO 1 Original No 1	ORJINAL NO 1 Original No 2	EŞDEĞER NO 1 Equivalent No 1	EŞDEĞER NO 1 Equivalent No 2	ÖLÇÜLER MM. Dimensions - MM.					TİP Type	MALZEME Material
045978	BESTA-CERES-BONGO	ÖN AKS Front Axle	OS11333067Y	S11333067	19026223	NJ892	52,00	70,00		9,00		L12L	NBR
046017	PRIDE-RIO	ÖN AKS İÇ Front Axle Inner	MB00133065Y	B00133065	19016576	-	52,00	68,00		7,00	13,20	SPL5LR	NBR
046016	PRIDE-RIO	ÖN AKS DIŞ Front Axle Outer	MB09233067Y	B09233067	19016501	-	51,00	63,00		8,50		SPL5L	NBR
045741	BESTA-CERES	ARKA AKS PORYA DIŞ Rear Axle Outer	60326157	-	-	-	48,00	70,00		10,00		L3L	NBR
047622	BONGO 2.7	ARKA AKS PORYA DIŞ Rear Axle Outer	KK9958555782	9004311080	19019061	-	55,00	78,00		12,00		L3L	NBR
047916	BONGO 2.7	ARKA AKS PORYA DIŞ-DIŞI SACLI Rear Axle Outer	KK9958555782	9004311080	19019061	-	55,00	78,00		12,00		L1L	NBR
047383	BONGO 2.7	ARKA AKS PORYA DIŞ Rear Axle Outer	K9958565903	974232	19027713	-	65,00	90,00		13,00		L3L	NBR
040909	BONGO 2.7	ARKA AKS PORYA DIŞ Rear Axle Outer	OK60A26157	-	-	-	32,00	39,00		8,00		SPLL5	NBR
045992	BESTA-CERES	ARKA AKS PORYA İÇ Rear Axle Inner	0060326154Y	60326154	19019538	-	35,00	55,00		8,00		L1L	NBR
040948	BONGO 2.7	ARKA AKS PORYA İÇ Rear Axle Inner	OK42A26157	-	-	-	36,50	43,00		8,00		SPLL5	NBR

DİFERANSİYEL GRUBU / Differential Group

SKT NO	KULLANILAN MODELLER Models	KULLANIM YERİ Place Of Use	ORJINAL NO 1 Original No 1	ORJINAL NO 2 Original No 2	EŞDEĞER NO 1 Equivalent No 1	EŞDEĞER NO 2 Equivalent No 2	ÖLÇÜLER MM. Dimensions - MM.					TİP Type	MALZEME Material
047737-V	BONGO 2.7	DİFERANSİYEL ÖN-MAHRUTİ Differential Front-Bevelgear	OK71027238	-	19035167	-	40,00	75,00	90,00	10,00	16,00	SPL1LR SAĞ-Right	FKM
045979-P	BESTA	DİFERANSİYEL ÖN-MAHRUTİ Differential Front-Bevelgear	OP01727165A	-	-	-	50,00	75,00		12,00	17,00	L1LR	ACM
046262-P	CERATO-PICANTO-RIO- 1.0-1.2-1.4 BENZ.	DİFERANSİYEL SAĞ ÇIKIŞ Dif.-Right Output	4311928010	4311928070	-	-	35,00	56,00	62,00	9,00	11,40	SPL1L SAĞ-Right	ACM
046265-P	CERATO-PICANTO-RIO- 1.4-1.5-1.6-2.0 CRDI	DİFERANSİYEL SAĞ ÇIKIŞ Dif.-Right Output	4311939020	-	-	-	39,30	61,30		7,50	12,80	SPL1L SAĞ-Right	ACM
046269-P	CEED-CERATO-PICANTO-RIO-SPORTAGE 1.4-1.5.1.6-2.0 BENZİN-2.0 CRDI	DİFERANSİYEL SAĞ ÇIKIŞ Dif.-Right Output	4311939070	-	-	-	41,00	61,00	68,00	8,10	12,90	SPL1L SAĞ-Right	ACM
046267-P	CERATO-PICANTO-RIO- 1.0-1.2-1.4 BENZ.	DİFERANSİYEL SOL ÇIKIŞ Differential Left Output	4311928020	4311928080	-	-	35,00	56,00	62,00	9,00	11,40	SPL1L SOL- Left	ACM
046264-P	CEED-CERATO-PICANTO- 1.5-1.6-2.0 CRDI	DİFERANSİYEL SOL ÇIKIŞ Differential Left Output	4311939080	4311939060	-	-	41,00	61,00	68,00	8,10	12,90	SPL1LL SOL-Left	ACM
045920-P	CERATO	DİFERANSİYEL SAĞ-SOL ÇIKIŞ Dif.-Right/Left Output	4311928001	91206PE6004	49440628	-	35,00	56,00		7,50	11,50	L3TLR SS-RL	ACM

ŞANZİMAN GRUBU / Gearbox Group

SKT NO	KULLANILAN MODELLER Models	KULLANIM YERİ Place Of Use	ORJINAL NO 1 Original No 1	ORJINAL NO 2 Original No 2	EŞDEĞER NO 1 Equivalent No 1	EŞDEĞER NO 2 Equivalent No 2	ÖLÇÜLER MM. Dimensions - MM.					TİP Type	MALZEME Material
041306-P	CEED-CERATO-PICANTO-1.5-1.6 CRDI	ŞANZİMAN ÖN Gearbox Front	4313439011	4313434000	19027874	247.260	25,00	35,00		6,00		SPL3L SAĞ-Right	ACM
046263-P	SPORTAGE-CERATO-1.6 CRDI MOT.	ŞANZİMAN ARKA Gearbox Rear	452453B410	452453B410	-	-	37,00	64,00		10,00	17,00	SPL3LR SOL-Left	ACM
045976-P	BESTA	ŞANZİMAN ARKA Gearbox Rear	OM50217335A	M50217335A	19033798	-	38,00	51,00	58,00	13,00	15,00	SPL12CLL- SOL-Left	ACM
045977-P	BONGO 2.7	ŞANZİMAN ARKA Gearbox Rear	OK71E17336AY	-	-	-	40,00	72,00	53,00	16,00	30,00	SPL1CLL SOL-Left	ACM
040437	BESTA-CERES	VİTES SEÇİCİ MİLİ Gear Selection Shaft	0024917485Y	-	12035822	-	14,00	20,00		5,00		L2	NBR

DİREKSİYON GRUBU / Steering Group

SKT NO	KULLANILAN MODELLER Models	KULLANIM YERİ Place Of Use	ORJINAL NO 1 Original No 1	ORJINAL NO 2 Original No 2	EŞDEĞER NO 1 Equivalent No 1	EŞDEĞER NO 2 Equivalent No 2	ÖLÇÜLER MM. Dimensions - MM.					TİP Type	MALZEME Material
041134	BESTA	DİREKSİYON KUTUSU Steering Box	-	-	12012530	-	19,05	34,60		6,20	9,20	L3BL	NBR

MOTOR GRUBU / Engine Group

SKT NO	KULLANILAN MODELLER Models	KULLANIM YERİ Place Of Use	ORJINAL NO 1 Original No 1	ORJINAL NO 1 Original No 2	EŞDEĞER NO 1 Equivalent No 1	EŞDEĞER NO 1 Equivalent No 2	ÖLÇÜLER MM. Dimensions - MM.					TİP Type	MALZEME Material
040738-P	SAMARA	KRANK ÖN Crank Shaft Front	21081005034	-	12016518	549.968	28,00	42,00		7,00		L3TL SAĞ -Right	ACM
040738-V	SAMARA	KRANK ÖN Crank Shaft Front	21081005034	-	16012080	549.968	28,00	42,00		7,00		L3TL SAĞ -Right	FKM
045448	2101-2102-2103-2105-NIVA	KRANK ÖN Crank Shaft Front	21011005034	212141005040	12011455	-	40,00	56,00		7,00		L1 SAĞ -Right	NBR
045448-S	SAMARA	KRANK ÖN Crank Shaft Front	21011005034	-	12011455	325.007 059.790	40,00	56,00		7,00		L1 SAĞ -Right	VMQ
047343-S	2101-2102-2103-2105-NIVA	KRANK ARKA Crank Shaft Rear	21011005160	-	12011438	042.102	70,00	90,00		10,00		L1 SOL -Left	VMQ
047643-S	SAMARA	KRANK ARKA Crank Shaft Rear	21081005160	-	12013361	546.941	80,00	100,00		10,00		L1L SOL -Left	VMQ
45-021-V	2101-2012-2103-2105-NIVA	SUPAP Valve Stem Seal	21011007026	-	12014584 49472013	294.110	8,00	10,80	14,20	6,00	10,00	LSY2T	FKM

AKS GRUBU / Axle Group

SKT NO	KULLANILAN MODELLER Models	KULLANIM YERİ Place Of Use	ORJINAL NO 1 Original No 1	ORJINAL NO 1 Original No 2	EŞDEĞER NO 1 Equivalent No 1	EŞDEĞER NO 1 Equivalent No 2	ÖLÇÜLER MM. Dimensions - MM.					TİP Type	MALZEME Material
045449	2101-2102-2103	ÖN AKS Front Axle	21013103038	-	12011501	-	40,00	57,15		10,00		L1	NBR
045843	NIVA	ÖN AKS Front Axle	21213103038	-	12016929	-	56,00	73,15		10,00		L1L	NBR
040323	2101-2102-2103-2105-NIVA	ARKA AKS Rear Axle	21012401034	-	12011493	-	30,00	45,00		8,00		L1	NBR

DİFERANSİYEL GRUBU / Differential Group

SKT NO	KULLANILAN MODELLER Models	KULLANIM YERİ Place Of Use	ORJINAL NO 1 Original No 1	ORJINAL NO 1 Original No 2	EŞDEĞER NO 1 Equivalent No 1	EŞDEĞER NO 1 Equivalent No 2	ÖLÇÜLER MM. Dimensions - MM.				TİP Type	MALZEME Material
045523	2101-2102-2103-2105-NIVA	DİFERANSİYEL ÖN-MAHRUTİ Differential Front-Bevelgear	21012402052	-	12011293	-	36,00	68,00		10,00	L1CL SAĞ -Right	NBR
045841	SAMARA	DİFERANSİYEL SAĞ ÇIKIŞ Dif.-Right Output	21082301034	-	-	-	35,00	57,00		9,00	L1L SAĞ -Right	NBR
045842	SAMARA	DİFERANSİYEL SOL ÇIKIŞ Differential Left Output	21082301035	-	-	-	35,00	57,00		9,00	L1L SOL -Left	NBR

ŞANZİMAN GRUBU / Gearbox Group

SKT NO	KULLANILAN MODELLER Models	KULLANIM YERİ Place Of Use	ORJINAL NO 1 Original No 1	ORJINAL NO 1 Original No 2	EŞDEĞER NO 1 Equivalent No 1	EŞDEĞER NO 1 Equivalent No 2	ÖLÇÜLER MM. Dimensions - MM.				TİP Type	MALZEME Material
040322	2101-2102-2103-2105-NIVA	ŞANZİMAN ÖN Gearbox Front	21011701043	-	12011445	-	28,00	47,00		8,00	L1 SAĞ -Right	NBR
045447	OTOMOBİL EM	ŞANZİMAN ARKA Gearbox Rear	40000240	40002860	12011450	13073PRSA	32,00	56,00		10,00	L1L SOL -Left	NBR
045611-P	2101-2102-2103-2105-NIVA	ŞANZİMAN ARKA Gearbox Rear	21011701210	-	12011450	-	32,00	56,00		11,00	L1L SOL -Left	ACM
045523	2101-2102-2103-2105-	ŞANZ. PTO MİLİ Power Take Off Shaft	21012402052	-	12011293	-	36,00	68,00		10,00	L1CL SAĞ -Right	NBR

DİREKSİYON GRUBU / Steering Group

SKT NO	KULLANILAN MODELLER Models	KULLANIM YERİ Place Of Use	ORJINAL NO 1 Original No 1	ORJINAL NO 1 Original No 2	EŞDEĞER NO 1 Equivalent No 1	EŞDEĞER NO 1 Equivalent No 2	ÖLÇÜLER MM. Dimensions - MM.				TİP Type	MALZEME Material
040404	SAMARA-NIVA	DİREKSİYON SİSTEMİ Steering System	21013401023	-	12011489	-	28,00	43,00		10,00	L1	NBR

MOTOR GRUBU / Engine Group

SKT NO	KULLANILAN MODELLER Models	KULLANIM YERİ Place Of Use	ORJINAL NO 1 Original No 1	ORJINAL NO 2 Original No 2	EŞDEĞER NO 1 Equivalent No 1	EŞDEĞER NO 2 Equivalent No 2	ÖLÇÜLER MM. Dimensions - MM.				TİP Type	MALZEME Material
041199-V	DELTA-Y10-YPSLON- 1.0-1.1-1.2 16V	KRANK ÖN Crank Shaft Front	40004200	-	12011305 12015553	440.710	23,00	35,00		7,00	L13L SAĞ -Right	FKM
041200-V	DELTA-MUSA-YPSILON-1.2-1.4 8V/16V	KRANK ÖN Crank Shaft Front	71740681	46404094	12016529	069.540 81-37461-00	27,00	37,00		7,00	L13TL SAĞ -Right	FKM
040597-S	DELTA 2.0 16V	KRANK ÖN Crank Shaft Front	5957615	40004250	12001470	-	30,00	43,00		8,00	L1 SAĞ -Right	VMQ
040944-V	DEDRA-DELTA-KAPPA-MUSA-YPSLON	KRANK ÖN Crank Shaft Front	7628850	7628822 55227599	12018321	069.590	31,00	41,00		7,00	L13TL SAĞ -Right	FKM
046122-V	MUSA-YPSLON-GAMMA	KRANK ÖN Crank Shaft Front	55186757	-	12019250 01029649	445.060	40,00	52,00		7,00	L13TL SAĞ -Right	FKM
045898-V	Y10-DEDRA-DELTA-LYBRA- 1.0 MOT.	KRANK ÖN Crank Shaft Front	40004950	-	12015853	440.760	40,00	56,00		7,00	L13TL SAĞ -Right	FKM
045968-V	DELTA-LYBRA-PHEDRA-ZETA	KRANK ÖN Crank Shaft Front	9400127479	9614194980	20015456 12010742	040.363 393.990	42,00	62,00		7,00	L13TL SAĞ -Right	FKM
046274-V	THEMA	KRANK ÖN Crank Shaft Front	46108224	-	12014608	761.796	44,00	60,00		10,00	L13TL SAĞ -Right	FKM
045827-V	KAPPA-THEMA 3.0	KRANK ÖN Crank Shaft Front	60567607	60807827	12012045	586.676	48,00	65,00		10,00	L13TL SAĞ -Right	FKM
045990-V	THEMA 2500T	KRANK ÖN Crank Shaft Front	98428409	40003650	12015120	419.730	55,00	70,00		8,00	L13TL SAĞ -Right	FKM
047640-V	DEDRA-DELTA-PRISMA 1.4-1.5-1.6	KRANK ARKA Crank Shaft Rear	40004350	-	12012069	440.780	64,00	80,00		8,00	L13TL SOL -Left	FKM
047343-S	DELTA-PRISMA 1.6	KRANK ARKA Crank Shaft Rear	40004290	-	12001482	042.102	70,00	90,00		10,00	L1 SOL -Left	VMQ
047759-V	DELTA-MUSA-Y10-YPSLON 1.2 8V -1.4 MOT. 8V-16V	KRANK ARKA Crank Shaft Rear	7724665	71754491	12015268	069.600	74,00	88,00		8,00	L13TL SOL -Left	FKM
047601-P	EM-OLD MODELS 1.6	KRANK ARKA Crank Shaft Rear	40004310	-	12001483	-	74,00	90,00		10,00	L13TL SOL -Left	ACM
047601-V	BETA-DEDRA-PRISMA-THEMA 1.6	KRANK ARKA Crank Shaft Rear	40004300	4358946	12001540	440.830	74,00	90,00		10,00	L13TL SOL -Left	FKM
417136-V	DELTA-MUSA-YPSILON 1.2-1.4 16V BENZİNLİ	KRANK ARKA Crank Shaft Rear	46539824	-	12018929	375.320	74,00	187,50	141,00	17,00	SPL1L 6 SOL-Left	FKM
047838-FP	YPSILON-MUSA 1.3 MJTD	KRANK ARKA Crank Shaft Rear	55180937	93177284	20032405	428.970	78,00	100,00		9,00	F2TL SOL -Left	PTFE+ACM
047645-V	YPSILON-MUSA 1.3 MJTD EURO 4/5/6	KRANK ARKA Crank Shaft Rear	55180937	93177284	20032405	428.970	78,00	100,00		10,00	L13TL SOL -Left	FKM

MOTOR GRUBU / Engine Group

SKT NO	KULLANILAN MODELLER Models	KULLANIM YERİ Place Of Use	ORJINAL NO 1 Original No 1	ORJINAL NO 2 Original No 2	EŞDEĞER NO 1 Equivalent No 1	EŞDEĞER NO 2 Equivalent No 2	ÖLÇÜLER MM. Dimensions - MM.				TİP Type	MALZEME Material
410382-V	DELTA-THEMA-PHEDRA-ZETA	KRANK ARKA Crank Shaft Rear	9614379380	-	20015455	508.209 511.064	90,00	110,00		7,00	L3TL SOL -Left	FKM
415185-V	DEDRA-DELTA-KAPPA-MUSA-THESIS	KRANK ARKA Crank Shaft Rear	614965	46435514	12015763	199.191	93,00	140,00	172,00	15,00	SPL1L SOL -Left	FKM
412189-V	THEMA	KRANK ARKA Crank Shaft Rear	46123797	-	12015384	323.772	110,00	130,00		13,00	L1L SOL -Left	FKM
041256-V	PHEDRA-ZETA 2.0 JTD	EKSANTRİK MİLİ Cam Shaft	9400807289	-	20026123	153.740	27,00	47,00		7,00	L3TL SAĞ -Right	FKM
041247-V	1.6-1.9-2.0 MJTD-JTDM-DELTA-MUSO-THESIS	EKSANTRİK MİLİ Cam Shaft	46802577	-	19016667	434.500	30,00	45,00		7,00	L13TL SAĞ -Right	FKM
045819-P	DEDRA-DELTA-PRISMA-THEMA-Y10	EKSANTRİK MİLİ Cam Shaft	40004460	40004330	12012411	212.458 440.750	30,00	52,00		7,00	L13T SAĞ -Right	ACM
045844-P	DEDRA-THEMA-Y10 1.6 16V	EKSANTRİK MİLİ Cam Shaft	40004930	-	12015854	332.220 440.750	30,00	52,00		7,00	L13T SAĞ -Right	ACM
040789-V	DEDRA-KAPPA-LYBRA-MUSA-THEMA-YPSILON	EKSANTRİK MİLİ Cam Shaft	40004400	7604177 55196125	12011839 12019621	277.142 505.838	30,00	42,00		7,00	L3T SAĞ -Right	FKM
046242-V	YPSILON 1.2 MOT.	EKSANTRİK MİLİ Cam Shaft	55189997	-	12019439	688.580	31,00	55,00		7,00	L13TL SAĞ -Right	FKM
040946-V	KAPPA-THEMA-THESIS-V6	EKSANTRİK MİLİ Cam Shaft	60610985	60808083	12014699	325.155	32,00	47,00		10,00	L3TL SS- RL	FKM
041287-V	PHEDRA-ZETA	EKSANTRİK MİLİ Cam Shaft	9400236499	-	20015457 07022633	505.366	36,00	50,00		7,00	L3TL SAĞ -Right	FKM
041250-V	PHEDRA	EKSANTRİK MİLİ Cam Shaft	9609874280	-	20018317	135.140 81-34146-00	38,00	50,00		6,00	L3TL SAĞ -Right	FKM
046217-V	DELTA-MUSA-YPSILON	EKSANTRİK MİLİ Cam Shaft	46434591	-	12016528 46085500	290.710	40,00	55,00		7,00	L13TL SAĞ -Right	FKM
041206-P	DELTA-DEDRA-LYBRA- 1.6 16V	YARDIMCI MİL Auxiliary Shaft	40004960	7794301	12015927	291.440	30,00	47,00		7,00	L13TL SAĞ -Right	ACM
040880-P	DELTA-LYBRA-Y10-YPSILON 1.1-1.2 8V	YARDIMCI MİL Auxiliary Shaft	40004240	-	12010674 19026772	277.142 440.720	30,00	42,00		7,00	L3TL SAĞ -Right	ACM
45-067-V	YPSILON-MUSA 1.2-1.4 MOT	SUPAP Valve Stem Seal	55190344	-	12017224	12018089 70-34223-00	5,00	7,80	11,00	8,00	LSY2T	FKM
45-057-V	1.6-1.9-2.0 MJTD-JTDM-DELTA-MUSA-THESIS	SUPAP Valve Stem Seal	55183812	-	19037053	506.550	5,00	10,00	23,40	15,40	LSY5T	FKM
45-068-V	PHEDRA-ZETA 2.0 JTD	SUPAP Valve Stem Seal	9400956489	-	12016913	49472877	6,00	10,00	19,60	21,50	LSY5T	FKM

MOTOR GRUBU / Engine Group

SKT NO	KULLANILAN MODELLER Models	KULLANIM YERİ Place Of Use	ORJINAL NO 1 Original No 1	ORJINAL NO 2 Original No 2	EŞDEĞER NO 1 Equivalent No 1	EŞDEĞER NO 2 Equivalent No 2	ÖLÇÜLER MM. Dimensions - MM.				TİP Type	MALZEME Material	
45-045-V	DELTA-MUSA-YPSLON 1.2-1.4 16V MOT.	SUPAP Valve Stem Seal	46470334	-	12016586 49472882	069.630 70-33512-00	6,00	8,80	11,70	9,50		LSY2T	FKM
45-033-V	DEDRA-DELTA-KAPPA-Y10-YPSLON	SUPAP Valve Stem Seal	7581344	7553616	12015802 12015802	701.289 70-26058-00	7,00	9,80	13,20	10,00		LSY2T	FKM
45-021-V	DEDRA-DELTA-LYBRA-MUSA-THEMA-Y10-ZETA	SUPAP Valve Stem Seal	7553637	5959598	12014584 49472013	195.952 294.110	8,00	10,80	14,20	10,00		LSY2T	FKM
45-051-V	MUSA-YPSLON-1.1-1.2-1.4 16V	SUPAP Valve Stem Seal	40101573	-	12015512 49472020	104.380 143.930	8,00	12,00	15,20	9,50		LSY2T	FKM

DİFERANSİYEL GRUBU / Differential Group

SKT NO	KULLANILAN MODELLER Models	KULLANIM YERİ Place Of Use	ORJINAL NO 1 Original No 1	ORJINAL NO 2 Original No 2	EŞDEĞER NO 1 Equivalent No 1	EŞDEĞER NO 2 Equivalent No 2	ÖLÇÜLER MM. Dimensions - MM.				TİP Type	MALZEME Material	
045899-P	OTOMOBİL SERİSİ	DİFERANSİYEL ÖN-MAHRUTİ Differential Front-Bevelgear	40004630	-	12015266	12036825	36,00	54,00		10,00	13,50	L13TLR SAĞ-Right	ACM
041139-P	DEDRA-DELTA-LYBRA-THEMA-YPSLON	DİFERANSİYEL SAĞ ÇIKIŞ Dif.-Right Output	40004760	40003040	12014825	-	29,80	50,00		10,00	13,50	L13TLR SAĞ-Right	ACM
041276-PF	PHEDRA-ZETA 2.0	DİFERANSİYEL SAĞ ÇIKIŞ Dif.-Right Output	9790464500	-	20028963	505.090	29,90	47,00		11,30		L3TF SS- RL	ACM+PTFE
046121-P	DEDRA-DELTA-PRISMA-YPSILON-LYBRA 1.3 MJET	DİFERANSİYEL SOL ÇIKIŞ Differential Left Output	40004830	40003050	12014824	-	29,80	52,00		10,00	13,50	L13TLR SOL-Left	ACM
045900-P	MUSA-YPSILON 1.2-1.4 16V	DİFERANSİYEL SOL ÇIKIŞ Differential Left Output	40004620	-	12015267	-	36,00	56,00		10,00	13,50	L13TLR SOL-Left	ACM
046123-VP	PHEDRA-ZETA- 2.0-2.1-2.2 TD-JTD	DİFERANSİYEL SOL ÇIKIŞ Differential Left Output	9456182580	9456182580	20020137	504.581	40,00	58,00		10,00		L3TL SS- RL	FKM+ACM
410389-P	DEDRA-DELTA-LYBRA 1.4İ-1.6İ	DİFERANSİYEL SAĞ-SOL ÇIKIŞ Dif.-Right/Left Output	7634888	-	12012342	-	63,00	96,00	105,00	11,00		SPCL5	ACM

ŞANZIMAN GRUBU / Gearbox Group

SKT NO	KULLANILAN MODELLER Models	KULLANIM YERİ Place Of Use	ORJINAL NO 1 Original No 1	ORJINAL NO 2 Original No 2	EŞDEĞER NO 1 Equivalent No 1	EŞDEĞER NO 2 Equivalent No 2	ÖLÇÜLER MM. Dimensions - MM.					TİP Type	MALZEME Material
040818-P	YPSLON-1.-2/1.4/1.6 16V	ŞANZIMAN ÖN Gearbox Front	40004670	91111183	12014345	618RDAC	19,80	40,00		5,50	8,20	SPSL SAĞ -Right	ACM
041063-P	DEDRA-DELTA-LYBRA-YPSILON- 1.3 MJET	ŞANZIMAN ÖN Gearbox Front	40004820	60808453	12014316	-	22,80	40,00		6,00	8,50	SLL SAĞ -Right	ACM
040884	PHEDRA-ZETA 2.0 16V	ŞANZIMAN ÖN Gearbox Front	9614067080	-	07015547	131.860	23,00	36,00		7,00		L3TL SAĞ -Right	NBR
041268-P	PHEDRA	ŞANZIMAN ÖN Gearbox Front	9655315780	-	07034872	-	26,80	41,00		9,20		SPL3TL SAĞ-Right	ACM
040322	DELTA-DEDRA-KAPPA-THEMA 2.0 16V	ŞANZIMAN ÖN Gearbox Front	40000180	40004510	12011445	-	28,00	47,00		8,00		L1 SAĞ -Right	NBR
045884-V	THESIS 2.4 JTD	ŞANZIMAN ÖN Gearbox Front	71734264	71740625	01033292	-	35,00	54,90	61,20	9,00	14,70	SPL1L SS-RL	FKM
040817-P	YPSLON-1.-2/1.4/1.6 16V	VİTES SEÇİCİ MİLİ Gear Selection Shaft	40004800	40001700	12001623	610PAC	20,00	30,00		7,00		L13TL	ACM

MAGIRUS / OTOKAR

MOTOR GRUBU / Engine Group

SKT NO	KULLANILAN MODELLER Models	KULLANIM YERİ Place Of Use	ORJINAL NO 1 Original No 1	ORJINAL NO 1 Original No 2	EŞDEĞER NO 1 Equivalent No 1	EŞDEĞER NO 1 Equivalent No 2	ÖLÇÜLER MM. Dimensions - MM.					TİP Type	MALZEME Material
047868-V	DEUTZ FL 912-913 MOT.	KRANK ÖN Crank Shaft Front	02234133 04150782	04152348	12012095	033.457	65,00	85,00		13,00		SPLİL SAĞ -Right	FKM
412364-V	DEUTZ FL 912-913 MOT.	KRANK ARKA Crank Shaft Rear	04230392	04232267	12012148 20020387	033.376	115,00	140,00		13,50		SPL3TL SOL-Left	FKM
412259-S	OTOKAR 80-MİN.-MİD. SERİSİ	KRANK ARKA Crank Shaft Rear	1101580602	-	-	-	115,00	140,00		16,00		L3L SOL -Left	VMQ
412302-V	OTOKAR 80-MİN.-MİD. SERİSİ	KRANK ARKA Crank Shaft Rear	4230392	-	12012148 20020387	033.376	115,00	140,00		16,00		L13TL SOL -Left	FKM
415164-S	F4L-F8L-714 V6 MOT.	KRANK ARKA Crank Shaft Rear	1160833	-	-	-	150,00	172,00		18,30		L3T SOL -Left	VMQ
047727-V	OTOKAR 80-MİN.-MİD. SERİSİ	EKSANTRİK MİLİ Cam Shaft	4154144	04154144	01029745	81-21527-20	65,00	85,00		10,50		L13TL SAĞ -Right	FKM
047568-S	OTOKAR 80-MİN.-MİD. SERİSİ	EKSANTRİK MİLİ Cam Shaft	2133781	-	-	-	65,00	85,00		13,00		L3T SAĞ -Right	VMQ
45-041-V	DEUTZ FL 912-913 MOT. OTOKAR 80 SERİSİ	SUPAP Valve Stem Seal	04153728	-	12015512 49472020	761.389 104.380	8,00	12,00	15,50	5,50	9,50	LSY4T	FKM
040147	ESKİ MOT.	SU POMPASI Water Pump	14C0180626AA	-	12010848	-	25,00	37,00		7,00		L3	NBR

AKS GRUBU / Axle Group

SKT NO	KULLANILAN MODELLER Models	KULLANIM YERİ Place Of Use	ORJINAL NO 1 Original No 1	ORJINAL NO 1 Original No 2	EŞDEĞER NO 1 Equivalent No 1	EŞDEĞER NO 1 Equivalent No 2	ÖLÇÜLER MM. Dimensions - MM.					TİP Type	MALZEME Material
047863-H	MİNİBÜS - MİDİBÜS	ÖN AKS Front Axle	9900048814AA	-	-	-	50,00	78,00		9,00	14,50	SC6	HNBR
047748-V	M2000 SERİSİ	ÖN AKS Front Axle	-	-	-	-	65,00	84,00		10,00		L13TL	FKM
047059	OTOKAR 80-MİN.-MİD. SERİSİ	ÖN AKS Front Axle	1100080600AA	38505699	12011026	042.391	80,00	100,00		10,00		L3	NBR
047521	OTOKAR 80-MİN.-MİD. SERİSİ	ÖN AKS Front Axle	-	-	07016735	-	80,00	100,00		10,00		L1L	NBR
412170	OTOKAR 80-MİN.-MİD. SERİSİ	ARKA AKS Rear Axle	12A1405032AA	-	-	-	120,00	140,00		12,00	14,00	L1L	NBR
412305	OTOKAR 80-MİN.-MİD. SERİSİ	ARKA AKS Rear Axle	1100080601AA	-	12000556	-	120,00	140,00		13,00		L13TL SS-RL	NBR

DİFERANSİYEL GRUBU / Differential Group

SKT NO	KULLANILAN MODELLER Models	KULLANIM YERİ Place Of Use	ORJINAL NO 1 Original No 1	ORJINAL NO 2 Original No 2	EŞDEĞER NO 1 Equivalent No 1	EŞDEĞER NO 2 Equivalent No 2	ÖLÇÜLER MM. Dimensions - MM.					TİP Type	MALZEME Material
047388	OTOKAR 80-MİN.-MİD. SERİSİ	DİFERANSİYEL ÖN-MAHRUTİ Differential Front-Bevelgear	-	-	-	-	47,62	80,39	71,00	6,35	19,05	SPL1L	NBR
047575	OTOKAR 80-MİN.-MİD. SERİSİ	DİFERANSİYEL ÖN-MAHRUTİ Differential Front-Bevelgear	-	-	-	-	55,00	80,00		8,00		L3	NBR
047591	ESKİ MODELLER	DİFERANSİYEL ÖN-MAHRUTİ Differential Front-Bevelgear	-	-	-	-	55,00	80,00		10,00		L1L	NBR
047211	OTOKAR 80-MİN.-MİD. SERİSİ	DİFERANSİYEL ÖN-MAHRUTİ Differential Front-Bevelgear	23405J	-	-	-	55,00	80,00		12,00		L3	NBR

ŞANZİMAN GRUBU / Gearbox Group

SKT NO	KULLANILAN MODELLER Models	KULLANIM YERİ Place Of Use	ORJINAL NO 1 Original No 1	ORJINAL NO 2 Original No 2	EŞDEĞER NO 1 Equivalent No 1	EŞDEĞER NO 2 Equivalent No 2	ÖLÇÜLER MM. Dimensions - MM.					TİP Type	MALZEME Material
040543	M2000 SERİSİ	ŞANZİMAN ÖN Gearbox Front	540979	-	-	-	31,75	44,55		6,35		L1L	NBR
045224	OTOKAR 80-MİN.-MİD. SERİSİ	ŞANZİMAN ÖN Gearbox Front	50742240	H645	12010910	-	35,00	56,00		10,00		L3	NBR
045600	OTOKAR 80-MİN.-MİD. SERİSİ	ŞANZİMAN ÖN Gearbox Front	-	-	01002839	12011148	35,00	62,00		12,00		L1L	NBR
045743	OTOKAR 80-MİN.-MİD. SERİSİ	ŞANZİMAN ÖN Gearbox Front	0634300541	5000241551	01002604	-	48,00	62,00		10,00		L1L	NBR
047747-P	M2000 SERİSİ	ŞANZİMAN ARKA Gearbox Rear	-	-	-	-	57,15	82,70		9,52		L1L SOL -Left	ACM
045647	OTOKAR 80-MİN.-MİD. SERİSİ	ŞANZİMAN ARKA Gearbox Rear	-	-	-	-	58,00	72,00		8,00		L1L	NBR
045794	OTOKAR 80-MİN.-MİD. SERİSİ	ŞANZİMAN ARKA Gearbox Rear	-	-	12010993	-	58,00	72,00		8,00		L3L	NBR

MAGIRUS / OTOKAR

DİREKSİYON GRUBU / Steering Group

SKT NO	KULLANILAN MODELLER Models	KULLANIM YERİ Place Of Use	ORJINAL NO 1 Original No 1	ORJINAL NO 1 Original No 2	EŞDEĞER NO 1 Equivalent No 1	EŞDEĞER NO 1 Equivalent No 2	ÖLÇÜLER MM. Dimensions - MM.				TİP Type	MALZEME Material	
040820	OTOKAR 80-M2000	DİREKSİYON KUTUSU Steering Box	0770198122	-	12016820	-	20,00	30,00		7,00	8,00	L3BTL	NBR
040694	OTOKAR 80-MİN.-MİD. SERİSİ	DİREKSİYON POMPA Steering Pump	-	-	-	-	35,00	47,00		7,00		L3BTL	NBR

DİĞER ÜRÜNLER / Other Products

SKT NO	KULLANILAN MODELLER Models	KULLANIM YERİ Place Of Use	ORJINAL NO 1 Original No 1	ORJINAL NO 1 Original No 2	EŞDEĞER NO 1 Equivalent No 1	EŞDEĞER NO 1 Equivalent No 2	ÖLÇÜLER MM. Dimensions - MM.				TİP Type	MALZEME Material	
040513	OTOKAR 80-MİN.-MİD. SERİSİ	HAVALI KAPI SİSTEMİ Air Door System	-	-	-	-	19,00	30,00		7,00	10,00	L3L	NBR
040425	OTOKAR 80-MİN.-MİD. SERİSİ	HAVALI KAPI SİSTEMİ Air Door System	-	-	-	-	19,00	40,00		10,00		L3	NBR
040166	OTOKAR 80-MİN.-MİD. SERİSİ	HAVALI KAPI SİSTEMİ Air Door System	30187487	41249105	12010827	-	20,00	40,00		10,00		L3	NBR
040651	OTOKAR 80-MİN.-MİD. SERİSİ	HAVALI KAPI SİSTEMİ Air Door System	6562601408	2249302	12011120	12010838	22,00	40,00		7,00		L3L	NBR

MOTOR GRUBU / Engine Group

SKT NO	KULLANILAN MODELLER Models	KULLANIM YERİ Place Of Use	ORJINAL NO 1 Original No 1	ORJINAL NO 2 Original No 2	EŞDEĞER NO 1 Equivalent No 1	EŞDEĞER NO 2 Equivalent No 2	ÖLÇÜLER MM. Dimensions - MM.				TİP Type	MALZEME Material	
041077-FK	OTOMOBİL SERİSİ	KRANK ÖN Crank Shaft Front	1E1010602A/B	-	20029769	026.770	30,00	50,00		7,50		F2TK SAĞ -Right	PTFE+YÜN
041169-V	2-121 SERİSİ 1,25-1,6 MOT.	KRANK ÖN Crank Shaft Front	1E0610602	C40110602	15510081	023.590 81-33869-00	33,00	47,00		5,00		L3TL SAĞ -Right	FKM
040911-P	E2200-323-626	KRANK ÖN Crank Shaft Front	F80111602	-	12011842	022.170	34,00	48,00		7,00		L3L SAĞ -Right	ACM
046175-V	121-323-626-E-6-MX3-MX5	KRANK ÖN Crank Shaft Front	M13XF-10-602A	-	19025980	-	36,50	50,50	-	7,00	-	L3TL SAĞ -Right	FKM
045997-V	3-323	KRANK ÖN Crank Shaft Front	Y70110602	-	12015430	854.180	40,00	52,00		6,00		L3L SAĞ -Right	FKM
046119-FP	2-3-5-323	KRANK ÖN Crank Shaft Front	Y40110602	Y60110602	20029116	026.750	40,00	55,00		6,40		F2TL SAĞ -Right	PTFE+ACM
045980-P	B2500	KRANK ÖN Crank Shaft Front	3596216	VS0110602	19033844	NA5197	53,00	69,85		11,00		L3L SAĞ -Right	ACM
047600-V	121 III- 1.3-1.8	KRANK ARKA Crank Shaft Rear	1E0311312	-	12015675	763.713	79,38	95,65		11,11		L13TL SOL -Left	FKM
047851-FP	2-121-1.25-1.4 MOT.	KRANK ARKA Crank Shaft Rear	1784775	-	19036358	023.862 81-90011-00	80,00	182,00		19,40		SPF5L SOL-Left	PTFE+ACM
047877-V	323-626-6-MX3-MX5	KRANK ARKA Crank Shaft Rear	M13XF-11-312	-	19016503	-	83,00	100,00	-	9,00	-	L3TL SOL -Left	FKM
410443-FP	2-3-5-323-1.3-1.4-1.6 16V	KRANK ARKA Crank Shaft Rear	Y40111312	Y60111312	20029117 20034738	026.790	85,00	105,00		8,80		F2TL SOL -Left	PTFE+ACM
047817-V	3 SERİSİ 1.6	KRANK ARKA Crank Shaft Rear	Y70111312	614823	12015429	733.070	87,00	100,00		8,50		L1L SOL -Left	FKM
410341-V	E2200	KRANK ARKA Crank Shaft Rear	F80111399	12152257	12012579	702.994 569.120	90,00	110,00		12,00		L13TL SOL -Left	FKM
410385-V	E2200-T3000	KRANK ARKA Crank Shaft Rear	OVS01-11-399	-	-	-	101,57	125,00		13,00		L3L SOL -Left	FKM
041151-FP	2-3-5 SERİSİ	EKSANTRİK MİLİ Cam Shaft	Y40112602	Y60112602	20029115	026.740	27,00	47,00		7,00		F2TL SAĞ -Right	PTFE+ACM
041058-V	121 SERİSİ	EKSANTRİK MİLİ Cam Shaft	1E0810602	-	12013949	562.653	28,00	38,00		7,00		L3TL SAĞ -Right	FKM
040910-P	3-6-121-323-626-E2200	EKSANTRİK MİLİ Cam Shaft	955000008	B63010602	19026018	022.160	30,00	44,00		7,00		L3L SAĞ -Right	ACM
045901-V	2.0 MOT- OTOMOBİL SERİSİ	EKSANTRİK MİLİ Cam Shaft	928M6K292B5A	1663822	15015834	467.860	42,00	53,00		7,00		L3TL SAĞ -Right	FKM

MOTOR GRUBU / Engine Group

SKT NO	KULLANILAN MODELLER Models	KULLANIM YERİ Place Of Use	ORJINAL NO 1 Original No 1	ORJINAL NO 1 Original No 2	EŞDEĞER NO 1 Equivalent No 1	EŞDEĞER NO 1 Equivalent No 2	ÖLÇÜLER MM. Dimensions - MM.					TİP Type	MALZEME Material
45-047-V	3 SERİSİ	SUPAP Valve Stem Seal	Y60110155	1229886	19035752	262.650	5,50	9,50	18,10	14,00		LSYT	FKM
45-030-V	121 III	SUPAP Valve Stem Seal	1E0710155	-	12015512	761.389	8,00	12,00	15,20	5,70	9,50	LSY2T	FKM
45-051-V	121 III	SUPAP Valve Stem Seal	1E0710155	-	12015512	761.389	8,00	12,00	15,00	6,00	9,50	LSY2T	FKM
45-034-V	E2200-626	SUPAP Valve Stem Seal	01AA18500	-	-	-	8,00	14,00	15,00	7,50	11,00	LSY1	FKM
45-022-V	323	SUPAP Valve Stem Seal	Z50110F5	-	19027767 19018204	49472839	5,50	11,00		6,00	10,00	LSYT	FKM
041056-P	OTOMOBİL SERİSİ	YAĞ POMPASI Oil Pump	Y70210602	-	12015450	490.800	18,00	32,00		6,00		L3L SAĞ -Right	ACM
040725-V	E2200	ŞARJ DİNAMOSU Charger Shaft	R21324414	-	-	-	15,00	32,00		7,50		SPL3L	FKM
041274-P	3 SEDAN SERİSİ DV6 MOT.	ENJEKTÖR GÖVDE KEÇESİ Injector Body Seal	-	-	734.960	-	18,00	29,00		6,00		L2T	ACM

AKS GRUBU / Axle Group

SKT NO	KULLANILAN MODELLER Models	KULLANIM YERİ Place Of Use	ORJINAL NO 1 Original No 1	ORJINAL NO 1 Original No 2	EŞDEĞER NO 1 Equivalent No 1	EŞDEĞER NO 1 Equivalent No 2	ÖLÇÜLER MM. Dimensions - MM.					TİP Type	MALZEME Material
045225	OTOMOBİL SERİSİ	ÖN AKS Front Axle	1E0026154A	-	12011157	039.993	40,00	55,00		8,00		L3	NBR
045978	E2200	ÖN AKS Front Axle	0S11333067Y	S11333067	19026223	NJ892	52,00	70,00		9,00		L12L	NBR
046017	121-323	ÖN AKS İÇ Front Axle Inner	B00133065B	B00133065	19016576	-	52,00	68,00		7,00	13,20	SPL5R	NBR
046016	121-323	ÖN AKS DIŞ Front Axle Outer	B09233067	-	19016501	-	51,00	63,00		8,50		SPL5L	NBR
045741	E2200	ARKA AKS Rear Axle	UB4026157	-	-	-	48,00	70,00		10,00		L3L	NBR
045120	E2200	ARKA AKS PORYA DIŞ Rear Axle Outer	60426184	-	12011460	706.035	42,00	65,00		10,00	12,00	L3L	NBR
045992	E2200	ARKA AKS PORYA İÇ Rear Axle Inner	0060326154Y	60326154	19019538	-	35,00	55,00		8,00		L1L	NBR

AKS GRUBU / Axle Group

SKT NO	KULLANILAN MODELLER Models	KULLANIM YERİ Place Of Use	ORJINAL NO 1 Original No 1	ORJINAL NO 1 Original No 2	EŞDEĞER NO 1 Equivalent No 1	EŞDEĞER NO 1 Equivalent No 2	ÖLÇÜLER MM. Dimensions - MM.					TİP Type	MALZEME Material
045924	B2500	ARKA AKS PORYA İÇ Rear Axle Inner	5281043000	UB4026154	19019539	-	35,00	58,00		10,00		SPL3T	NBR
047496	E2200	ARKA AKS PORYA İÇ Rear Axle Inner	50.74.233.0	21529007010	12017076	-	58,00	80,00		13,00		L1L	NBR

DİFERANSİYEL GRUBU / Differential Group

SKT NO	KULLANILAN MODELLER Models	KULLANIM YERİ Place Of Use	ORJINAL NO 1 Original No 1	ORJINAL NO 1 Original No 2	EŞDEĞER NO 1 Equivalent No 1	EŞDEĞER NO 1 Equivalent No 2	ÖLÇÜLER MM. Dimensions - MM.					TİP Type	MALZEME Material
047737-V	929-RX7-E2200	DİFERANSİYEL ÖN-MAHRUTİ Differential Front-Bevelgear	R00127165	-	19035167	-	40,00	75,00	90,00	10,00	16,00	SPL1LR SAĞ-Right	FKM
046160-P	3-5-6-323-626-929-121	DİFERANSİYEL SAĞ-SOL ÇIKIŞ Dif.-Right/Left Output	F00327238A	F00427238	19016578	NJ452	35,00	56,00		9,00	14,80	L3LR	ACM
045979-P	E2200	DİFERANSİYEL ÖN-MAHRUTİ Differential Front-Bevelgear	W00127165	-	-	-	50,00	75,00		12,00	17,00	L1LR	ACM
045902-P	121	DİFERANSİYEL SAĞ-SOL ÇIKIŞ Dif.-Right/Left Output	YF0910602	-	12019597	-	40,00	55,00		8,00		L13L SS-RL	ACM

ŞANZİMAN GRUBU / Gearbox Group

SKT NO	KULLANILAN MODELLER Models	KULLANIM YERİ Place Of Use	ORJINAL NO 1 Original No 1	ORJINAL NO 1 Original No 2	EŞDEĞER NO 1 Equivalent No 1	EŞDEĞER NO 1 Equivalent No 2	ÖLÇÜLER MM. Dimensions - MM.					TİP Type	MALZEME Material
041061-V	3-5-6-323-626	ŞANZİMAN ÖN Gearbox Front	60316103	8943264410	19016656	-	27,00	43,00		9,00		L3TL SAĞ -Right	FKM
041235-P	5-6-323-626-929	ŞANZİMAN ÖN Gearbox Front	060316103	-	19016656	-	27,00	43,00	-	9,00	-	L3L SAĞ -Right	ACM
045609-P	323-626	ŞANZİMAN ÖN Gearbox Front	FT0119223	-	19026746	12014056	45,00	62,00		10,00		L3 SAĞ -Right	ACM
045976-P	E2200-B2500-RX7-929	ŞANZİMAN ARKA Gearbox Rear	M50217335A	3602087	19033798	-	38,00	51,00	58,00	13,00	15,00	SPL12CLL- SOL-Left	ACM
040595	323-626	VİTES SEÇİCİ MİLİ Gear Selection Shaft	9958616267	-	19029034	-	16,00	26,00		7,00		L3L	NBR

DİREKSİYON GRUBU / Steering Group

SKT NO	KULLANILAN MODELLER Models	KULLANIM YERİ Place Of Use	ORJINAL NO 1 Original No 1	ORJINAL NO 1 Original No 2	EŞDEĞER NO 1 Equivalent No 1	EŞDEĞER NO 1 Equivalent No 2	ÖLÇÜLER MM. Dimensions - MM.					TİP Type	MALZEME Material
040838	E2200-626	HİDROLİK DİREKSİYON Steering Box	-	-	01026536	-	18,00	30,00		6,00		L3BTL	NBR
040895	-	HİDROLİK DİREKSİYON Steering Box	34002505	-	12012530	-	19,00	34,70		6,20	9,20	SPL3BTL	NBR
041134	-	DİREKSİYON KUTUSU Steering Box	-	-	12012530	-	19,05	34,60		6,20	9,20	L3BL	NBR
041126	323	DİREKSİYON KUTUSU Steering Box	0770080273	0770198130	01016544	-	20,00	30,00		5,00	6,00	L3BTL	NBR

MOTOR GRUBU / Engine Group

SKT NO	KULLANILAN MODELLER Models	KULLANIM YERİ Place Of Use	ORJINAL NO 1 Original No 1	ORJINAL NO 2 Original No 2	EŞDEĞER NO 1 Equivalent No 1	EŞDEĞER NO 2 Equivalent No 2	ÖLÇÜLER MM. Dimensions - MM.				TİP Type	MALZEME Material
041169-V	190 SERİSİ	KRANK ÖN Crank Shaft Front	-	-	15510081	023.590 81-33869-00	33,00	47,00		5,00	L3TL SAĞ -Right	FKM
040969-V	123-124-190-C-E-G-S-SL-VITO	KRANK ÖN Crank Shaft Front	0139970046	-	12010739	294.357 475.961	35,00	48,00		10,00	L3TL SAĞ -Right	FKM
046231-V	MEK. 210-202-123-124	KRANK ÖN Crank Shaft Front	0109974747	0189970447	01020045	466.042	43,00	58,00		7,00	L13TL SAĞ -Right	FKM
046026-V	C-CLK-E-G-S-SPRINTER-VITO 601/611/646/647/648 MOT.	KRANK ÖN Crank Shaft Front	1209970346	-	12012248	914.924	45,00	67,00		8,00	L13TL SAĞ -Right	FKM
046224-FP	C-CLS-CLK-E-G-GL-GLK-S-SLK-SPRINTER	KRANK ÖN Crank Shaft Front	0189971947	0149977046	20026532	424.841	45,00	67,00		8,00	F2TL SAĞ -Right	PTFE+ACM
046222-V	A-B-C-E-M SERİSİ, SPRINTER, VIANO-VITO - DİZEL MOT.	KRANK ÖN Crank Shaft Front	0149972646	1227900QAA	19036884	742.950	60,00	75,00		8,00	SPL2TL ETS SAĞ-Right	FKM
047768-V	T2-0309-UNIMOĞ HAFİF TİCARİ 408-508-608-613-809 MOT.	KRANK ÖN Crank Shaft Front	0069975446	0099976146	12014380	283.983 553.272	65,00	90,00		13,00	L13TL SAĞ -Right	FKM
047832-FP	A-B-C-E-M SERİSİ, CITAN-CLA-G-GLA - DİZEL MOT.	KRANK ARKA Crank Shaft Rear	1609970146	1609970246	20030112 18034107	745.740	80,00	100,00		9,00	F2TL SOL-Left	PTFE+ACM
410236-V	MİNİBÜS-KAMYONET-EM	KRANK ARKA Crank Shaft Rear	6039970146	-	15510201	12017270	88,90	104,78		9,50	L3 SOL-Left	FKM
410351-V	190-W201-C-CLK-W124-S124	KRANK ARKA Crank Shaft Rear	0179977447	-	12012249	914.932	93,00	114,00		13,00	L3TL SOL-Left	FKM
415243-FAE	C-CLK-E-G-S-SPRINTER 601/611/646/647/648 MOT.	KRANK ARKA Crank Shaft Rear	6040100114	6110100214	20030144	746.400	93,00	133,50	155,00	15,50	SPF AL8	PTFE+AEM
410494-V	A-B-C-CLA-S-E-M SERİSİ, SPRINTER, VIANO-VITO - DİZEL MOT.	KRANK ARKA Crank Shaft Rear	0149972546	-	19036882	742.960	96,00	114,00		9,00	SP13TL ETS SOL-Left	FKM
040693-V	190 W201-C124-W124-W126- W140-E-G SERİSİ	EKSANTRİK MİLİ Cam Shaft	0189977947	-	12014403	508.489	30,00	40,00		7,00	L3T SAĞ-Right	FKM
45-064-V	A-B-C-E-S-G-M-SL SPRINTER-W124- VITO 111-104 MOT.	SUPAP Valve Stem Seal	0000534158	0000534358	12014586	830.489	7,00	10,00	13,50	8,50	LSY2T	FKM
45-035-V	VITO-109-111-115 CDI W639	SUPAP Valve Stem Seal	4220530196	-	12014525 49472954	562.298	12,00	16,00	20,00	15,00	LSY	FKM
45-038-V	190-W201-W123-W124-S124-200-E SERİSİ	SUPAP-EKSOZ Exhaust Valve	6010530258	1020530358	12012438 12020255	310.751	9,00	12,00	17,50	10,50	LY3	FKM
45-050-V	CW124-E-G-S-SPRINTER-VITO- 2.3 MOT. SERİSİ-W202-C200D	SUPAP-EKSOZ Exhaust Valve	0000534958	0000533558	19031083	49472874	9,00	12,00	15,40	10,50	LSY2T	FKM
45-018-V	KAMYONET-MİNİBUS	SUPAP-EKSOZ Exhaust Valve	3520530396	3520530296	12015882	325.813	9,00	15,00	19,00	15,00	LSY	FKM

MOTOR GRUBU / Engine Group

SKT NO	KULLANILAN MODELLER Models	KULLANIM YERİ Place Of Use	ORJINAL NO 1 Original No 1	ORJINAL NO 1 Original No 2	EŞDEĞER NO 1 Equivalent No 1	EŞDEĞER NO 1 Equivalent No 2	ÖLÇÜLER MM. Dimensions - MM.					TİP Type	MALZEME Material
45-025-V	E-S-SL-SLK-C-CLK-B-A -W169-A SERİSİ	SUPAP-EKSOZ Exhaust Valve	0000534658	-	12014670	724.590 70-33512-00	6,00	8,80	12,20	9,70		LSY2T	FKM
45-037-V	W124-S124-C124-W201-190 SERİSİ	SUPAP-EKSOZ Exhaust Valve	1020531658	1020530258	12015876	763.969	8,00	12,00	17,50	10,50		LY3	FKM
040953	W123-240D	YAKIT POMPASI Fuel Pump	0049974947	-	01002391	-	17,00	28,00		6,00		L1L	NBR
040257	W123-W460-240D-300D-G SERİSİ	YAKIT POMPASI Fuel Pump	0069976647	-	19035018	-	17,00	34,00		4,00		L3	NBR
040260	O 309	SU POMPASI Water Pump	1369970047	-	12010794	-	15,00	30,00		7,00		L3	NBR
040272	408 DG	SU POMPASI Water Pump	0059970147	59970147	12010810	154.003	17,00	35,00		7,00		L3	NBR
045645	323, L 710	SU POMPASI Water Pump	0039975146	0059970047	12010943	344.300	42,00	56,00		7,00		L3	NBR

AKS GRUBU / Axle Group

SKT NO	KULLANILAN MODELLER Models	KULLANIM YERİ Place Of Use	ORJINAL NO 1 Original No 1	ORJINAL NO 1 Original No 2	EŞDEĞER NO 1 Equivalent No 1	EŞDEĞER NO 1 Equivalent No 2	ÖLÇÜLER MM. Dimensions - MM.					TİP Type	MALZEME Material
045744	C111- 280-W109	ÖN AKS Front Axle	0039979346	-	01019288	-	45,00	62,00		10,00	12,00	L1L	NBR
046270-NH	CLS-E-S-SL (W211-212-216218-219)	ÖN AKS-MANY. ABS OKUYUCULU Front Axle-Magn.ABS Encoder	0259971647	-	01033874	-	53,00	73,00		10,00		ME L13L SS-RL	NBR+ HNBR
047247	O 309	ÖN AKS Front Axle	0059977046	-	01003247	-	53,98	76,20		12,50		SL	NBR
412147	323, L 710	ÖN AKS Front Axle	0039974047	0009973446	12011399	042.714	95,00	130,00		13,00		SL	NBR
410232	VITO-109-111-115-W639	ÖN AKS Front Axle	0079973646	-	12011400	592.609	100,00	120,00		13,00		SL	NBR
410263	VITO-109-111-115-W639	ÖN AKS Front Axle	0119977247	-	12015406	562.874	100,00	125,00		13,00		L3L	NBR
045870	SPRINTER 214/314	ÖN AKS İÇ Front Axle Inner	0189973147	-	01026327	456.140	55,00	75,00		8,00		L1L SS- RL	NBR
045637	W114- 250	ARKA AKS Rear Axle	0079973547	0059977146	12012242	-	59,00	72,00		12,00	12,50	L1L	NBR

AKS GRUBU / Axle Group

SKT NO	KULLANILAN MODELLER Models	KULLANIM YERİ Place Of Use	ORJINAL NO 1 Original No 1	ORJINAL NO 1 Original No 2	EŞDEĞER NO 1 Equivalent No 1	EŞDEĞER NO 1 Equivalent No 2	ÖLÇÜLER MM. Dimensions - MM.					TİP Type	MALZEME Material
046023-V	SPRINTER	ARKA AKS Rear Axle	902 997 0146-	902 997 0246	1026325	016.620	60,00	73,00	-	11,00	-	L13TL	FKM
047907-V	SPRINTER 515CDI 2006=>	ARKA AKS Rear Axle	0139976946	-	49358722	-	75,00	98,00		10,00		L13TL	FKM
047520	408 DG	ARKA AKS Rear Axle	0009971446	-	12011411	-	75,00	100,00		13,00		SLL	NBR
410244	O 309	ARKA AKS Rear Axle	0029976846	-	12011397	044.571	90,00	112,71		13,00		SL	NBR
410402-V	407 D, 408 D	ARKA AKS Rear Axle	0109972447	0109978747	12012563	567.795	95,00	115,00		13,00		L13TL SS-RL	FKM
412146	328, 911	ARKA AKS Rear Axle	0089974246	0009977446	12011404	612.103	110,00	140,00		13,00		SL	NBR

DİFERANSİYEL GRUBU / Differential Group

SKT NO	KULLANILAN MODELLER Models	KULLANIM YERİ Place Of Use	ORJINAL NO 1 Original No 1	ORJINAL NO 1 Original No 2	EŞDEĞER NO 1 Equivalent No 1	EŞDEĞER NO 1 Equivalent No 2	ÖLÇÜLER MM. Dimensions - MM.					TİP Type	MALZEME Material
046228-P	124-190-C-E-SLK	DİFERANSİYEL ÖN-MAHRUTİ Differential Front-Bevelgear	0089973147	0209971947	01019477	268.420	37,00	61,00		10,00	14,00	L13TLR SAĞ-Right	ACM
046251-V	G SERİSİ-SPRINTER-VITO	DİFERANSİYEL ÖN-MAHRUTİ Differential Front-Bevelgear	A0239975847	-	01033403	82033403	40,00	70,00		11,00	18,00	L13LR SAĞ-Right	FKM
046025-VP	G-W460-W463-SPRINTER	DİFERANSİYEL ÖN-MAHRUTİ Differential Front-Bevelgear	0179975547	-	01019478	398.420	40,00	70,00		13,00	20,00	SPL13LR SS-RL	FKM+ACM
046145-V	406, 408, 409, 410-0309	DİFERANSİYEL ÖN-MAHRUTİ Differential Front-Bevelgear	0129973047	0119977347	01034591	-	42,00	65,00		12,00		L13TL SAĞ -Right	FKM
047888-V	SPRINTER 3,5 T SERİSİ MİNİBÜS	DİFERANSİYEL ÖN-MAHRUTİ Differential Front-Bevelgear	0259975547	-	01035893	-	48,00	82,00		12,50	19,50	L13LL SAĞ -Right	FKM
047756-V	SPRINTER 414 2.3	DİFERANSİYEL ÖN-MAHRUTİ Differential Front-Bevelgear	0219975547	-	01019480	451.140	75,00	95,00		10,00		L13TL SS-RL	FKM
047902-P	124-C-CLK-E-S-SLK-VITO 202/203/210/ 638 ŞANZ.	DİFERANSİYEL ÖN-MAHRUTİ Differential Front-Bevelgear	0209972347	-	01020315	587.915 905.910	45,00	85,30		8,00	15,00	SPL13LR SS-RL	ACM

ŞANZIMAN GRUBU / Gearbox Group

SKT NO	KULLANILAN MODELLER Models	KULLANIM YERİ Place Of Use	ORJINAL NO 1 Original No 1	ORJINAL NO 2 Original No 2	EŞDEĞER NO 1 Equivalent No 1	EŞDEĞER NO 2 Equivalent No 2	ÖLÇÜLER MM. Dimensions - MM.				TİP Type	MALZEME Material	
040644-P	MB 100	ŞANZIMAN ÖN Gearbox Front	6319971746	-	16018446	01031967	28,00	40,00		7,00	8,50	L3TL SS-RL	ACM
041206-P	W114-A-B-SPRINTER-308-311-408-411-G-S SERİSİ	ŞANZIMAN ÖN Gearbox Front	0059976847	-	01002484	-	30,00	47,00		7,00		L13TL SAĞ -Right	ACM
046232-P	C-CLK-E-SLK-GLK-SPRINTER-VIANO-VITO 722.6 TİP. ŞANZ.	ŞANZIMAN ÖN Gearbox Front	0239975547	-	01034075	-	31,80	62,00		8,00		L13TL SAĞ -Right	ACM
046024-V	S-SL-W114	ŞANZIMAN ÖN-OTOMATİK Gearbox Front-Automatic	0089979146	-	01010901 01025607	048.364	34,00	52,00		8,00		L13TL SAĞ -Right	FKM
040816-V	SPRINTER	ŞANZIMAN ÖN Gearbox Front	0189979147	-	01019481	-	35,00	47,00		8,00		L3TL SAĞ -Right	FKM
040747-V	190-W201-A-VIANO	ŞANZIMAN ÖN-OTOMATİK Gearbox Front-Automatic	0109974547	-	20018100	757.292	35,00	50,00		7,00		L3TL SAĞ -Right	FKM
046213-V	G-S-SL-123-190 SERİLERİ	ŞANZIMAN ÖN Gearbox Front	99975347	-	01019289	-	35,00	52,00		7,00		L13TL SAĞ -Right	FKM
046231-V	MEKANİK ŞANZ. 210/202	ŞANZIMAN ÖN Gearbox Front	0109974747	-	01020045	466.042	43,00	58,00		7,00		L13TL SAĞ -Right	FKM
046231-V	A-B-C-E-CLK-G-SLK-SPRINTER-VIANO-VITO	ŞANZIMAN ÖN-OTOMATİK Gearbox Front-Automatic	0109974747	0189970447	01020045	466.042	43,00	58,00		7,00		L13TL SAĞ -Right	FKM
046022-V	VITO	ŞANZIMAN ÖN Gearbox Front	0089971947	0159970547	12015259	283.827	46,00	64,00		8,00		L13TL SAĞ -Right	FKM
045964-V	S SERİSİ-190-VITO-SL-G-W201-W114-W201	ŞANZIMAN ÖN Gearbox Front	0159971647	0119976247	12018806	141.960 465.194	52,00	68,00		8,00		L13TL SAĞ -Right	FKM
046253-V	123-124-190-C-CLK-E-S-SL-SLK SERİSİ	ŞANZIMAN ARKA Gearbox Rear	0149973547	2109970546	01019285	82019285	40,00	55,00		8,00		L13TL SOL -Left	FKM
045226-V	G SERİSİ-W461-230-280	ŞANZIMAN ARKA Gearbox Rear	0089975047	-	01019886	-	40,00	60,00		10,00		L3L	FKM
045700-V	VIANO-SPRINTER-123-124-C-E-S-SL- W639-CDI	ŞANZIMAN ARKA-OTOMATİK Gearbox Rear-Automatic	0129977847 0089977246	0089976647	01019150	330.809	40,00	62,00		10,00		L3L	FKM
046226-P	C-CLK-E-SLK-SPRINTER-722.6 TİP.ŞANZ.	ŞANZIMAN ARKA Gearbox Rear	0239975447	0239978747	01031902	82031902	42,00	62,00		8,00		L13TL SOL -Left	ACM
046131	MB 100	ŞANZIMAN ARKA Gearbox Rear	A6319972746	-	16018444	12013928	55,00	70,00		8,00	10,00	L3LL SS-RL	NBR
045477	O 309	ŞANZIMAN ARKA Gearbox Rear	0089971146	-	01003273	-	58,00	75,00		12,00		SL	NBR
047711-V	VITO	ŞANZIMAN ARKA Gearbox Rear	0079979847	0179972547	01020467	104.290	80,00	100,00		10,00		L13TL SS-RL	FKM

ŞANZIMAN GRUBU / Gearbox Group

SKT NO	KULLANILAN MODELLER Models	KULLANIM YERİ Place Of Use	ORJINAL NO 1 Original No 1	ORJINAL NO 2 Original No 2	EŞDEĞER NO 1 Equivalent No 1	EŞDEĞER NO 2 Equivalent No 2	ÖLÇÜLER MM. Dimensions - MM.				TİP Type	MALZEME Material	
045708	G SERİSİ-W460-280-300	ŞANZ.YARDIMCI MİL Gearbox Auxiliary Shaft	12010926	-	79978247	-	38,00	55,00		7,00	L3	NBR	
045361	-	ŞANZ. PTO MİLİ Power Take Off Shaft	0099975147	6504035100	12010908	258.407	35,00	52,00		10,00	L3L	NBR	
041279-P	124-A-C-CLK-E-G-S-SLK-VIANO-VITO- SPRINTER OTM.ŞANZ.	VİTES SEÇİCİ MİLİ Gear Selection Shaft	0069970147	0139970446	01029717	-	12,00	18,00		5,60	L13TL	ACM	
040591	MB 100	VİTES SEÇİCİ MİLİ Gear Selection Shaft	6319971646	-	16018445	-	16,00	28,00		7,00	7,50	L3L	NBR
041152	OTOMOBİL SERİSİ	VİTES SEÇİCİ MİLİ Gear Selection Shaft	6319971646	-	16018445	-	16,00	28,00		7,00	6,00	L3L SS-RL	NBR
041177	W114- 280, 280 E	VİTES SEÇİCİ MİLİ Gear Selection Shaft	0069974946	-	12014616	038.083	25,00	35,00		7,00		L13TL	NBR

DİREKSİYON GRUBU / Steering Group

SKT NO	KULLANILAN MODELLER Models	KULLANIM YERİ Place Of Use	ORJINAL NO 1 Original No 1	ORJINAL NO 2 Original No 2	EŞDEĞER NO 1 Equivalent No 1	EŞDEĞER NO 2 Equivalent No 2	ÖLÇÜLER MM. Dimensions - MM.				TİP Type	MALZEME Material
040758	190-220-300	DİREKSİYON MİLİ Steering Shaft	0009974846	0049976146	12010879	201.006	30,00	40,00		7,00	L3BTL	NBR
040850	L319-405-406-407	DİREKSİYON MİLİ Steering Shaft	0019979746	-	01001681	-	30,00	42,00		6,00	L3BTL	NBR
041138-H	SPRINTER	DİREKSİYON MİLİ Steering Shaft	2209970049	-	01026516	-	32,00	44,50		8,50	L3B	HNBR
045711	OTOMOBİL SERİSİ	DİREKSİYON MİLİ Steering Shaft	-	-	8060033101	-	45,00	62,00		8,00	L2	NBR
045813	OTOMOBİL SERİSİ	DİREKSİYON MİLİ Steering Shaft	0079977547	-	-	-	51,00	58,00		4,00	L5	NBR
041131-H	190-W201	DİREKSİYON KUTUSU Steering Box	-	-	19029685	-	19,05	33,30		7,90	L12BL- SAĞ-Right	HNBR
040840	190-220-230-300	DİREKSİYON KUTUSU Steering Box	019979646	-	07016442	-	20,00	32,00		7,00	L3BTL	NBR
040842	300 B-C-S	DİREKSİYON KUTUSU Steering Box	009972546	-	01034676 12010836	120.103	22,00	35,00		6,00	L3BTL	NBR
041124	OTOMOBİL SERİSİ	DİREKSİYON KUTUSU Steering Box	-	-	12014254	-	23,30	29,70		4,00	L2	NBR

DİREKSİYON GRUBU / Steering Group

SKT NO	KULLANILAN MODELLER Models	KULLANIM YERİ Place Of Use	ORJINAL NO 1 Original No 1	ORJINAL NO 2 Original No 2	EŞDEĞER NO 1 Equivalent No 1	EŞDEĞER NO 2 Equivalent No 2	ÖLÇÜLER MM. Dimensions - MM.				TİP Type	MALZEME Material	
041122-H	SPRINTER	DİREKSİYON KUTUSU Steering Box	0229971947	-	01019954	-	25,00	34,00		7,00		L3BT	HNBR
040610	HAFİF TİCARİ-OTOMOBİL	DİREKSİYON KUTUSU Steering Box	5000807966	770198034	12014826	-	26,00	37,00		7,00	8,00	L3L	NBR
040743	OTOMOBİL SERİSİ	DİREKSİYON KUTUSU Steering Box	0059973747	0089979447	12014826	006.408	26,00	37,00		7,00	8,00	L3BTL	NBR
041133	OTOMOBİL SERİSİ	DİREKSİYON KUTUSU Steering Box	-	-	01015867	-	28,00	38,00		7,00		SPL3B	NBR
040849	300 B-C-S	DİREKSİYON KUTUSU Steering Box	0770198036	-	19015774	-	28,00	40,00		6,00		L3BTL	NBR
041179	OTOMOBİL SERİSİ	DİREKSİYON KUTUSU Steering Box	0149976947	-	01020082	-	28,00	40,00		8,00		L3BLL	NBR
045829	OTOMOBİL SERİSİ	DİREKSİYON KUTUSU Steering Box	0119978046	-	237.760	-	54,80	70,00		9,00		L3BL	NBR
040838	180-190-220-300	DİREKSİYON KUTUSU Steering Box	1114630060	-	19026778	-	18,00	30,00		6,00		L3BTL	NBR
041316-HL	OTOMOBİL SERİSİ	DİREKSİYON KUTUSU Steering Box	7852033140	-	01031617	82031617	28,00	38,00		7,00		SPL3BL	HNBR+TPU

MOTOR GRUBU / Engine Group

SKT NO	KULLANILAN MODELLER Models	KULLANIM YERİ Place Of Use	ORJINAL NO 1 Original No 1	ORJINAL NO 2 Original No 2	EŞDEĞER NO 1 Equivalent No 1	EŞDEĞER NO 2 Equivalent No 2	ÖLÇÜLER MM. Dimensions - MM.				TİP Type	MALZEME Material	
041263-V	MINI COOPER SERİSİ	KRANK ÖN Crank Shaft Front	1111485171	-	19036883	583.050	32,00	45,00		6,00		L3L SAĞ -Right	FKM
040911-P	OTOMOBİL SERİSİ	KRANK ÖN Crank Shaft Front	551621703	-	12011842	022.170	34,00	48,00		7,00		L3L SAĞ -Right	ACM
046119-FP	CLUPMAN-COOPER D-ONE D (DV6)	KRANK ÖN Crank Shaft Front	11117805945	1608940680	20029116	026.750	40,00	55,00		6,40		F2TL SAĞ -Right	PTFE+ACM
046273-V	COOPER D-SD-ONE D	KRANK ÖN Crank Shaft Front	11117802665	-	19035978	584.160	55,00	68,00		8,00		L2TL ETS SAĞ-Right	FKM
046210-FP	COOPER SERİSİ 1.6 EP6 MOT.	KRANK ÖN Crank Shaft Front	11117568264	-	19035976	004.450	61,00	75,00		8,00		F2TL SAĞ -Right	PTFE+ACM
410496-V	MINI R50-R53-ONE D SERİSİ	KRANK ARKA Crank Shaft Rear	11147790960	-	19026734	575.450	75,00	107,00		8,00		L3TL SOL -Left	FKM
410443-FP	COOPER D-S-ONE- 1.6 EP6 MOT.	KRANK ARKA Crank Shaft Rear	11117805946	11117568263	20029117 20034738	026.790	85,00	105,00		8,80		F2TL SOL -Left	PTFE+ACM
410506-V	COOPER-ONE D	KRANK ARKA Crank Shaft Rear	11147797490	-	19036885	492.060	90,00	104,00		9,00		L25TL ETS SOL-Left	FKM
041250-V	OTOMOBİL SERİSİ	EKSANTRİK MİLİ Cam Shaft	11147790962	-	19033909	-	38,00	50,00		6,00		L3TL SAĞ -Right	FKM
046077-V	OTOMOBİL SERİSİ	EKSANTRİK MİLİ Cam Shaft	24217518705	24217580322	01033880	-	38,00	52,00		6,00		L3TL SAĞ -Right	FKM
45-065-V	COOPER S 1.6 BENZİN EP6 MOT.	SUPAP Valve Stem Seal	1611289780	1611510280	582.530	-	5,00	9,00	24,20	14,00		LSY5T	FKM
45-069-V	ONE D-R50-R53 SERİSİ	SUPAP Valve Stem Seal	11347791053	-	19034020 49472803	12020300	6,00	11,00		6,00	11,20	LSY	FKM
041274-P	COOPER D-ONE D-CLUB MAN 1.6 DV6 MOT.	ENJEKTÖR GÖVDE KEÇESİ Injector Body Seal	-	-	734.960	-	18,00	29,00		6,00		L2T	ACM

DİFERANSİYEL GRUBU / Differential Group

SKT NO	KULLANILAN MODELLER Models	KULLANIM YERİ Place Of Use	ORJINAL NO 1 Original No 1	ORJINAL NO 2 Original No 2	EŞDEĞER NO 1 Equivalent No 1	EŞDEĞER NO 2 Equivalent No 2	ÖLÇÜLER MM. Dimensions - MM.				TİP Type	MALZEME Material	
046268-P	PACEMAN-COUNTRYMAN	DİFER. SAĞ-SOL ÇIKIŞ Dif.-Right/Left Output	33107505601	1214967	01025620	82025620	44,00	67,00		10,00	15,50	L13LR SS-RL	ACM
046079-VL	PACEMAN-COUNTRYMAN	ARKA AKS Rear Axle	39722364	-	15001202	-	34,90	54,00		11,30		L3TLL	FKM+TPU
045698	OTOMOBİL SERİSİ	ARKA AKS Rear Axle	34662364	-	12010962	-	48,00	62,00		8,00		L3L	NBR

MOTOR GRUBU / Engine Group

SKT NO	KULLANILAN MODELLER Models	KULLANIM YERİ Place Of Use	ORJINAL NO 1 Original No 1	ORJINAL NO 2 Original No 2	EŞDEĞER NO 1 Equivalent No 1	EŞDEĞER NO 2 Equivalent No 2	ÖLÇÜLER MM. Dimensions - MM.					TİP Type	MALZEME Material
041272-FP	LANCER-OUTLANDER 2.0 D	KRANK ÖN Crank Shaft Front	MN980030	-	20026413	129.780	32,00	47,00		10,00		F2TL SAĞ -Right	PTFE+ACM
041273-FP	COLT-LANCER-OUTLANDER 1.8GTI-2.0 DID	KRANK ÖN Crank Shaft Front	MN980009	-	20026412	155.560	35,00	48,00		10,00		F2TL SAĞ -Right	PTFE+ACM
046007-V	CARISMA-SPACESTAR-LANCER- 1.9 D-ID	KRANK ÖN Crank Shaft Front	M862838	-	12018755	157.200 981.480	42,00	54,00		6,00		L3TL SAĞ -Right	FKM
045792-P	L200-L300-COLT-GALANT-LANCER	KRANK ÖN Crank Shaft Front	MD069949	-	19027863 19027863	247.280	44,00	60,00		7,00		L3L SAĞ -Right	ACM
045922-V	L200-L300-GALANT-LANCER-COLT -2.0/2.4	KRANK ÖN Crank Shaft Front	MD343563	-	19027863 19012585	247.280	44,00	60,00		7,00		L13TL SAĞ -Right	FKM
047704-V	L200-L300-COLT-LANCER	KRANK ARKA Crank Shaft Rear	MB308965	-	19027853	034.530	72,00	96,00		9,00		L13TL SOL -Left	FKM
047705-V	L200-L300-COLT-GALANT	KRANK ARKA Crank Shaft Rear	MD343564	-	19034967	247.290	80,00	96,00		9,00		L13TL SOL -Left	FKM
410276-V	CARISMA	KRANK ARKA Crank Shaft Rear	-	-	12012347	258.280 81-23708-50	85,00	105,00		12,00		L3TL SOL -Left	FKM
410386-V	CARISMA 1.9 TD-GALANT 2.0	KRANK ARKA Crank Shaft Rear	M287542	-	12015424	508.462 81-23708-50	85,00	105,00		8,00		L3TL SOL -Left	FKM
410456-V	L200-L300-GALANT	KRANK ARKA Crank Shaft Rear	MD120669	MD101915	19027858 19016595	NA5140	91,00	111,00		9,00		L3L SOL -Left	FKM
040692-V	CARISMA	EKSANTRİK MİLİ Cam Shaft	M287556	7703087192	12013862	508.544	25,00	42,00		8,00		L3T SAĞ -Right	FKM
041256-V	OUTLANDER 2.2 DI-D	EKSANTRİK MİLİ Cam Shaft	MN982134	-	20026123	153.740	27,00	47,00		7,00		L3TL SAĞ -Right	FKM
040831-V	L200-L300-COLT-GALANT-LANCER 2.5 TD	EKSANTRİK MİLİ Cam Shaft	MD133317	MD153103	12013459	293.946	35,00	50,00		8,00		L13TL SAĞ -Right	FKM
45-067-V	COLT VI-SPACE STAR 1.1-1.3-1.5-1.6 MOT.	SUPAP Valve Stem Seal	MR984262	-	12051827	12018089	5,00	7,80	11,00	8,00		LSY2T	FKM
45-025-V	COLT-LANCER	SUPAP Valve Stem Seal	MN960095	-	12014670	724.590 70-33512-00	6,00	8,80	12,20	6,00	10,00	LSY2T	FKM
45-033-V	CARISMA	SUPAP Valve Stem Seal	M889394	MW30638662	12015802	701.289 70-26058-00	7,00	9,80	13,20	5,00	10,00	LSY2T	FKM
45-029-V	L200-L300	SUPAP Valve Stem Seal	MD000508	MD070695	19019230	010.270	8,00	13,00	15,35	9,00	13,25	LSY	FKM
040833-V	L200-L300-COLT-GALANT	BALANS MİLİ-KÜÇÜK Eng. Damper Shaft	2132142021	MD069948	19020127	-	17,00	28,00		7,00		L13TL SAĞ -Right	FKM

MOTOR GRUBU / Engine Group

SKT NO	KULLANILAN MODELLER Models	KULLANIM YERİ Place Of Use	ORJINAL NO 1 Original No 1	ORJINAL NO 1 Original No 2	EŞDEĞER NO 1 Equivalent No 1	EŞDEĞER NO 1 Equivalent No 2	ÖLÇÜLER MM. Dimensions - MM.				TİP Type	MALZEME Material	
040832-V	L200-L300-COLT-GALANT 2.5 TD	BALANS MİLİ-BÜYÜK Eng. Damper Shaft	MD069950	MD168059	19020128	-	25,00	35,00		6,00		L13TL SAĞ -Right	FKM
040755-P	COLT-LANCER	BALANS MİLİ Eng. Damper Shaft	MD008883	878T7048A2A	19016593	-	28,00	40,00		8,00		L3TL SAĞ -Right	ACM
040934-P	L200-L300	ŞARJ DİNAMOSU Charger Shaft	-	-	-	-	14,80	30,00		5,00		L2	ACM
040935-P	L200-L300	ŞARJ DİNAMOSU Charger Shaft	-	-	-	-	14,80	30,00		5,00		LL3	ACM
4TM-065	L200-L300 (040934-P + 040935-P)	ŞARJ DİNAMOSU Charger Shaft	-	-	-	-						TM	-

AKS GRUBU / Axle Group

SKT NO	KULLANILAN MODELLER Models	KULLANIM YERİ Place Of Use	ORJINAL NO 1 Original No 1	ORJINAL NO 1 Original No 2	EŞDEĞER NO 1 Equivalent No 1	EŞDEĞER NO 1 Equivalent No 2	ÖLÇÜLER MM. Dimensions - MM.				TİP Type	MALZEME Material	
045731	L200-L300	ÖN AKS Front Axle	MT141132	-	19019080	041.114	50,00	65,00		8,00		L1L	NBR
045870	LANCER	ÖN AKS İÇ Front Axle Inner	-	-	01026327	456.140	55,00	75,00		8,00		L1L SS-RL	NBR
046014	L200-L300	ARKA AKS Rear Axle	MB092288	-	19016508	NJ540	37,00	62,00		14,00		SPL3	NBR
045742	L200-L300	ARKA AKS Rear Axle	MB092437	-	19016509	NJ539	50,00	65,00		10,00		L1L	NBR
045802	COLT-LANCER	ARKA AKS Rear Axle	MA125991	MA181498	19016505	NJ068	52,00	65,00		9,00		L1L	NBR
045966	L200-L300	ARKA AKS PORYA DIŞ Rear Axle Outer	MB393719	MB001314	19019079	-	45,00	58,00		9,00		L1L	NBR
045924	L200-L300	ARKA AKS PORYA İÇ Rear Axle Inner	MB095527	5270143300	19019539	-	35,00	58,00		10,00		SPL3T	NBR
045965	L300	ARKA AKS PORYA İÇ Rear Axle Inner	MB837719	MB664439	19026226	-	38,00	62,00		12,50		SPL3L	NBR

DİFERANSİYEL GRUBU / Differential Group

SKT NO	KULLANILAN MODELLER Models	KULLANIM YERİ Place Of Use	ORJINAL NO 1 Original No 1	ORJINAL NO 2 Original No 2	EŞDEĞER NO 1 Equivalent No 1	EŞDEĞER NO 2 Equivalent No 2	ÖLÇÜLER MM. Dimensions - MM.				TİP Type	MALZEME Material	
046259-P	CARISMA-SPACESTAR-1.3-1.6 16V	DİFERANSİYEL ÖN-MAHRUTİ Differential Front-Bevelgear	M819932	MW30651965	01029132	050.560	27,95	56,00		7,00		L3TL SAĞ -Right	ACM
046251-V	LANCER IV	DİFERANSİYEL ÖN-MAHRUTİ Differential Front-Bevelgear	-	-	01033403	82033403	40,00	70,00		11,00	18,00	L13LR SAĞ-Right	FKM
045939-P	L200-L300-PAJERO	DİFERANSİYEL ÖN-MAHRUTİ Differential Front-Bevelgear	MB160949	MR580530	19016663	NJ739	45,00	72,00		12,00	19,50	L1LR SAĞ -Right	ACM
046160-P	COLT-LANCER-GALANT	DİFERANSİYEL SAĞ-SOL ÇIKIŞ Dif.-Right/Left Output	MB393932	MD707184	19016578	NJ452	35,00	56,00		9,00	14,80	L3LR	ACM

ŞANZİMAN GRUBU / Gearbox Group

SKT NO	KULLANILAN MODELLER Models	KULLANIM YERİ Place Of Use	ORJINAL NO 1 Original No 1	ORJINAL NO 2 Original No 2	EŞDEĞER NO 1 Equivalent No 1	EŞDEĞER NO 2 Equivalent No 2	ÖLÇÜLER MM. Dimensions - MM.				TİP Type	MALZEME Material	
040588-P	L200-L300-COLT-LANCER-GALANT	ŞANZİMAN ÖN Gearbox Front	MD741818	MD050608	19027874	247.260	25,00	35,00		6,00		L3L SAĞ -Right	ACM
041306-P	COLT-GALANT 1.8-2.0 16V	ŞANZİMAN ÖN Gearbox Front	MD741818	MO050608	19016660	247.260	25,00	35,00		6,00		SPL3L SAĞ-Right	ACM
040829-P	L200-L300-PAJERO	ŞANZİMAN ÖN Gearbox Front	MD723202	431434A001	19027850	-	30,00	45,00		6,00		L12L SAĞ -Right	ACM
045789-P	OTOMOBİL SERİSİ	ŞANZİMAN ÖN Gearbox Front	M342487	-	12015423	-	27,95	70,00		10,00		L3TL SAĞ -Right	ACM
045921-P	L200-L300	ŞANZİMAN ARKA Gearbox Rear	MD703343	2504A012	19015088	NJ612	36,00	52,00		10,00		L3TL SOL -Left	ACM
045226-V	SPACESTAR 2.0	ŞANZİMAN ARKA Gearbox Rear	MV684481	-	01034065	-	40,00	60,00		10,00		L3L	FKM
046226-P	LANCER VI	ŞANZİMAN ARKA Gearbox Rear	-	-	01031902	82031902	42,00	62,00		8,00		L13TL SOL-Left	ACM
040603	GALANT-LANCER	ŞANZ. KLM ÇIKIŞ MİLİ Speedometer Shaft	-	-	-	-	28,00	40,00		8,00		L3L	NBR
041117-P	OTOMOBİL SERİSİ	VİTES SEÇİCİ MİLİ Gear Selection Shaft	M343801	-	12018001	-	16,00	26,00	36,00	10,00	12,00	SPL3TL	ACM
040643-P	CARISMA-SPACESTAR	VİTES SEÇİCİ MİLİ Gear Selection Shaft	M343801	-	12018001	-	16,00	26,00	36,00	10,40	12,00	SPL3L	ACM
040711-P	GALANT-LANCER	ARAZİ ŞANZİMANI 4x4 Transfer Box 4x4	MR983368	-	19016661	-	32,00	48,00		10,00		L3L SOL -Left	ACM

DİREKSİYON GRUBU / Steering Group

SKT NO	KULLANILAN MODELLER Models	KULLANIM YERİ Place Of Use	ORJINAL NO 1 Original No 1	ORJINAL NO 1 Original No 2	EŞDEĞER NO 1 Equivalent No 1	EŞDEĞER NO 1 Equivalent No 2	ÖLÇÜLER MM. Dimensions - MM.				TİP Type	MALZEME Material	
040850	L200	DİREKSİYON SİSTEMİ Steering System	8194388	99971147	1001681	112.109	30,00	42,00		6,00		L3BTL	NBR
041124	L300	DİREKSİYON KUTUSU Steering Box	-	-	12014254	-	23,30	29,70		4,00		L2	NBR
040928-H	L200-L300	DİREKSİYON SİSTEMİ Steering System	-	-	19019964	-	18,70	35,00		8,00		L3BL	HNBR

MOTOR GRUBU / Engine Group

SKT NO	KULLANILAN MODELLER Models	KULLANIM YERİ Place Of Use	ORJINAL NO 1 Original No 1	ORJINAL NO 2 Original No 2	EŞDEĞER NO 1 Equivalent No 1	EŞDEĞER NO 2 Equivalent No 2	ÖLÇÜLER MM. Dimensions - MM.					TİP Type	MALZEME Material
040877-P	OTOMOBİL SERİSİ	KRANK ÖN Crank Shaft Front	32113N2101		19016672		34,00	50,00	0,00	7,00	0,00	L3L SAĞ -Right	ACM
041114-V	OTOMOBİL SERİSİ	KRANK ÖN Crank Shaft Front	1351000QAA	1351000AQQ	20019851	504.483	35,00	47,00		6,00		L3TL SAĞ -Right	FKM
041116-FP	QASHQAI 1.5 DCI	KRANK ÖN Crank Shaft Front	1351000QAD	-	20030268	431.420	35,00	47,00		7,00		F2TL SAĞ -Right	PTFE+ACM
046007-V	SUNNY-INTERSTAR-PRIMASTAR 1.9 DCI-2.0 DCI-2.5 DCI	KRANK ÖN Crank Shaft Front	1351000QAF	-	12018755	157.200 941.480	42,00	54,00		6,00		L3TL SAĞ -Right	FKM
047908-FAEL	QASGHAI-NAVARA-X-TRAIL- 1.6 DCI- 2.0 DCI	KRANK ÖN Crank Shaft Front	1351000QOA	-	19036731	260.320	50,00	81,00		11,50		SPF SAĞ -Right	PTFE+ AEM+TPU
047495-P	URVAN-PICK-UP 2.5	KRANK ÖN Crank Shaft Front	13043T7200	-	12010700	-	58,00	80,00		10,00		L3L SAĞ -Right	ACM
047904-FP	KUBISTRAR 1.2 MOT.	KRANK ARKA Crank Shaft Rear	1227900QAD	-	20029611	169.650	70,00	86,00		7,00		F2TL SOL -Left	PTFE+ACM
047832-FP	JUKE-MICRA-NOTE-QASHQAI 1.5 DCI	KRANK ARKA Crank Shaft Rear	111130BN700	1227900QAE	20030112 20034107	745.740	80,00	100,00		9,00		F2TL SOL -Left	PTFE+ACM
410497-V	JUKE-MICRA-NOTE-QASHQAI-X-TRAIL 1.2-1.6-2.0	KRANK ARKA Crank Shaft Rear	122791HCOA	122793VA0A	19034989	471.060	84,00	117,00		8,50		L3TL SOL -Left	FKM
410503-VAE	PRIMERA-INTERSTAR-PRIMASTAR- DCI 90-1.9 DCI	KRANK ARKA Crank Shaft Rear	7703087224- 4404963-9112963	1227900QAB	20018246	711.720	85,00	105,00		6,80	11,00	L3TL SOL -Left	FKM+AEM
410443-FP	OTOMOBİL SERİSİ	KRANK ARKA Crank Shaft Rear	122796F90A	-	20029117	026.790	85,00	105,00		8,80		F2TL SOL -Left	PTFE+ACM
047663-S	PICK-UP 2.5-3.0 DI NISSAN MOT.	KRANK ARKA Crank Shaft Rear	1227943G00	-	20029180	247.380	86,00	100,00		10,00		L3L SO L-Left	VMQ
417137-FAE	QUASGHAI- X-TRAIL-1.6 DCI- 2.0 DCI	KRANK ARKA Crank Shaft Rear	1227900QOA	-	19036732	729.010 800.570	94,00	161,00	192,00	10,00		SPL1 SOL -Left 8	PTFE+AEM
040692-V	OTOMOBİL SERİSİ	EKSANTRİK MİLİ Cam Shaft	1351000QAC	-	12015425	812638930	25,00	42,00		8,00		L3T SAĞ -Right	FKM
041115-V	MICRA-ALMERA-QASHQAI 1.5 DCI	EKSANTRİK MİLİ Cam Shaft	13042BN700	1351000QAB	12018754	073.890	28,00	42,00		5,00		L3TL SAĞ -Right	FKM
041278-FP	PRIMERA 1.5 DCI	EKSANTRİK MİLİ Cam Shaft	1300100QAC	-	20035460	584.880 81-38506-00	28,00	42,00		6,00		F2TL SAĞ -Right	PTFE+ACM
041198-V	MICRA-SUNNY	EKSANTRİK MİLİ Cam Shaft	1351000QAE	-	20019850	365.940	30,00	42,00		6,00		L3TL SAĞ -Right	FKM
041287-V	MICRA II	EKSANTRİK MİLİ Cam Shaft	130426F900	-	20015457 07022633	505.366	36,00	50,00		7,00		L3TL SAĞ -Right	FKM

MOTOR GRUBU / Engine Group

SKT NO	KULLANILAN MODELLER Models	KULLANIM YERİ Place Of Use	ORJINAL NO 1 Original No 1	ORJINAL NO 1 Original No 2	EŞDEĞER NO 1 Equivalent No 1	EŞDEĞER NO 1 Equivalent No 2	ÖLÇÜLER MM. Dimensions - MM.					TİP Type	MALZEME Material
047870-VP	INTERSTAR-PRIMASTAR	YARDIMCI MİL Auxiliary Shaft	165800QAA	-	46085512	-	70,00	85,00		7,00		L3TL SAĞ -Right	FKM+ACM
45-025-V	QASHQAI 1.5 DCI	SUPAP Valve Stem Seal	7700109840	-	12014670	724.590 70-33512-00	6,00	8,80	12,20	6,00	10,00	LSV2T	FKM

DİFERANSİYEL GRUBU / Differential Group

SKT NO	KULLANILAN MODELLER Models	KULLANIM YERİ Place Of Use	ORJINAL NO 1 Original No 1	ORJINAL NO 1 Original No 2	EŞDEĞER NO 1 Equivalent No 1	EŞDEĞER NO 1 Equivalent No 2	ÖLÇÜLER MM. Dimensions - MM.					TİP Type	MALZEME Material
046259-P	INTERSTAR-PRIMASTAR	DİFERANSİYEL SAĞ ÇIKIŞ Dif.-Right Output	3818900QAA	-	01029132	050.560	27,95	56,00		7,00		L3TL SAĞ -Right	ACM
046157-V	OTOMOBİL SERİSİ	DİFERANSİYEL SAĞ ÇIKIŞ Dif.-Right Output	3818900QAD	-	12017115	-	30,00	52,00		7,00		L3TL SAĞ -Right	FKM
046118-FP	QASHQAI-ALMERA-MICRA-NOTE	DİFERANSİYEL SAĞ ÇIKIŞ Differential Right Output	3818900QOA	-	20033804	1954012	33,00	55,00		8,50	13,50	L3TFR SAĞ-Right	PTFE+ACM
046123-VP	QASHQAI EDC ŞANZ.	DİFERANSİYEL SAĞ ÇIKIŞ Differential Right Output	383426F900	7903087070	20020137	102.946	40,00	58,00	0,00	10,00	0,00	L3TL SS- RL	FKM+ACM
046117-P	QASHQAI-ALMERA-MICRA-NOTE	DİFERANSİYEL SOL ÇIKIŞ Dif.-Left Output	3834200QAB	38242AX000	01033808	964.880	40,00	55,00		8,00	13,00	L3TLR SS-RL	ACM
046252-V	QASGHAI 1.5 DCI-OTM. EDC TİP ŞANZ.	DİF. SAĞ-SOL ÇIKIŞ OTM.ŞANZ. Dif.-Right/Left Output-Auto.	383427234R	-	9009059560	-	40,00	55,00		8,50		L13TLL SS-RL	FKM

ŞANZIMAN GRUBU / Gearbox Group

SKT NO	KULLANILAN MODELLER Models	KULLANIM YERİ Place Of Use	ORJINAL NO 1 Original No 1	ORJINAL NO 1 Original No 2	EŞDEĞER NO 1 Equivalent No 1	EŞDEĞER NO 1 Equivalent No 2	ÖLÇÜLER MM. Dimensions - MM.					TİP Type	MALZEME Material
041285-P	JUKE-NOTE-QASHQAI-X-TRAIL	ŞANZIMAN ÖN Gearbox Front	3211300QAB	-	19036867	-	24,50	42,00		6,00		L3TL SAĞ -Right	ACM
041168-P	ALMERA-PRIMERA	ŞANZIMAN ÖN Gearbox Front	31113AW602	6184211	12015750	-	27,00	42,00		6,00		L3TL SAĞ -Right	ACM
040604	LAND CRUISER-CELICA-COROLLA 1.8-HIACE	ŞANZIMAN ÖN Gearbox Front	3213618000	-	19015048	-	30,00	45,00		8,00		L3L	NBR
045678-P	QASHQAI	ŞANZIMAN ÖN Gearbox Front	-	-	49364336	-	40,00	62,00	0,00	8,00	0,00	L3TL	ACM

DİREKSİYON GRUBU / Steering Group

SKT NO	KULLANILAN MODELLER Models	KULLANIM YERİ Place Of Use	ORJINAL NO 1 Original No 1	ORJINAL NO 1 Original No 2	EŞDEĞER NO 1 Equivalent No 1	EŞDEĞER NO 1 Equivalent No 2	ÖLÇÜLER MM. Dimensions - MM.					TİP Type	MALZEME Material
041134	PRIMERA	HİDROLİK DİREKSİYON KUTUSU Power Steering Box	-	-	12012530	-	19,00	34,60		6,20	9,20	L3BL	NBR
041124	PRIMERA	HİDROLİK DİREKSİYON KUTUSU Power Steering Box	-	-	12014254	-	23,30	29,70		4,00		L2	NBR
041125	PRIMERA	HİDROLİK DİREKSİYON KUTUSU Power Steering Box	-	-	12000626	-	24,97	37,54	41,24	4,20	7,40	SPL3B	NBR
040902	PRIMERA	HİDROLİK DİREKSİYON KUTUSU Power Steering Box	-	-	-	-	19,00	30,00		6,00		SPL3BL	NBR
040892	PRIMERA	HİDROLİK DİREKSİYON KUTUSU Power Steering Box	-	-	15020022	-	25,00	37,75	41,12	4,50	7,50	SPL3B	NBR

MOTOR GRUBU / Engine Group

SKT NO	KULLANILAN MODELLER Models	KULLANIM YERİ Place Of Use	ORJINAL NO 1 Original No 1	ORJINAL NO 2 Original No 2	EŞDEĞER NO 1 Equivalent No 1	EŞDEĞER NO 2 Equivalent No 2	ÖLÇÜLER MM. Dimensions - MM.				TİP Type	MALZEME Material	
040812-V	ASTRA-CORSA-MERİVA-TİGRA-VECTRA-ZAFİRA	KRANK ÖN Crank Shaft Front	646816	646262	12013858	755.141	26,00	42,00		8,00		L3TL SAĞ -Right	FKM
040944-V	ASTRA J-INSIGNIA A-VECTRA-ZAFİRA 1.6 D 1.9 CDT- MULTIJET	KRANK ÖN Crank Shaft Front	5646262	93180737	12018321	069.590	31,00	41,00		7,00		L13TL SAĞ -Right	FKM
040800-V	ASTRA-OMEGA-VECTRA	KRANK ÖN Crank Shaft Front	646265	646263	12013458	330.736	31,00	50,00		8,00		L13L SAĞ -Right	FKM
041303-V	INSIGNIA A-ASTRA G-H-J-CORSA D-E ZAFİRA 1.6 16V- Z16XER-A16XER	KRANK ÖN Crank Shaft Front	646299	24465791	20031720	056.900 81-35147-00	31,50	42,00		7,00		L13TL SAĞ -Right	FKM
041263-V	ANTARA 2.0 CDTI	KRANK ÖN Crank Shaft Front	4805071	-	19036883	583.050	32,00	45,00		6,00		L3L SAĞ -Right	FKM
040946-V	COMBO	KRANK ÖN Crank Shaft Front	068103085E	026103085F	12012709	325.155 325.156	32,00	47,00		10,00		L3TL SS -RL	FKM
040969-V	ASTRA F-COMBO-VECTRA A	KRANK ÖN Crank Shaft Front	0544115147B	034115137A	12010739	294.357 475.961	35,00	48,00		10,00		L3TL SAĞ -Right	FKM
040740-V	ASTRA F-G VECTRA A	KRANK ÖN Crank Shaft Front	646266	646294	12013459 19016568	507.725 507.806	35,00	50,00		8,00		L3TL SAĞ -Right	FKM
045997-V	COMBO-ASTRA-CORSA-MERİVA	KRANK ÖN Crank Shaft Front	614822	98041049	12015430	854.180	40,00	52,00		6,00		L3L SAĞ -Right	FKM
046122-V	ASTRA-CORSA-MERİVA 1.3 CDTI EURO 4/5/6	KRANK ÖN Crank Shaft Front	646910	649089	12019250 01029649	445.060	40,00	52,00		7,00		L13TL SAĞ -Right	FKM
046161-V	AGILA 1.0-1.2 MOT.	KRANK ÖN Crank Shaft Front	4709000	93193839	19034959	351.180 717.710	41,00	53,00		6,00		L3L SAĞ -Right	FKM
046007-V	VİVARO 2.0-1.9DTI	KRANK ÖN Crank Shaft Front	4402706	7700103245	12018755	157.200 981.480	42,00	54,00		6,00		L3TL SAĞ -Right	FKM
045882-V	ASTRA J-CORSA C/D-MERİVA-TIGRA-VECTRA-ADAM-ANTERA-1.2-1.4-2.2	KRANK ÖN Crank Shaft Front	638199 / 12609467	4812899	20020389	127.610	42,00	55,00		7,00		L3TL SAĞ -Right	FKM
046026-V	ASTRA F- CORSA A-OMEGA-VESTRA A	KRANK ÖN Crank Shaft Front	-	-	12012248	914.924	45,00	67,00		8,00		L13TL SAĞ -Right	FKM
046239-VK	CAMPO-MONTEREY-FRONTERA-VECTRA	KRANK ÖN Crank Shaft Front	614835	94369516	19033958	933.180	50,00	68,00		9,00		SPL3K SAĞ-Right	FKM+YÜN
046255-V	ASTRA J-K-INSIGNIA A-B- MOKKA-MERİVA-ZAFİRA 1.6 CDTI	KRANK ÖN Crank Shaft Front	614214	55596779	49423886	562.000	53,00	72,00		9,00	15,50	L25TLR ETS	FKM
046158-VP	MOVANO-VİVARO 2.5 DTI-CDTI-G9U	KRANK ÖN Crank Shaft Front	4403530	9111530	46085509	505.110	60,00	75,00		7,00		L3TL SAĞ -Right	FKM
047870-VP	MOVANO A -VİVARO A 2.5 CDTI-G9U	KRANK ÖN Crank Shaft Front	4403528	9111528	46085512	542.060	70,00	85,00		7,00		L3TL SAĞ -Right	FKM

MOTOR GRUBU / Engine Group

SKT NO	KULLANILAN MODELLER Models	KULLANIM YERİ Place Of Use	ORJINAL NO 1 Original No 1	ORJINAL NO 2 Original No 2	EŞDEĞER NO 1 Equivalent No 1	EŞDEĞER NO 2 Equivalent No 2	ÖLÇÜLER MM. Dimensions - MM.				TİP Type	MALZEME Material	
047386-S	ASCONA-KADETT-RECORD-COMMADORE	KRANK ARKA Crank Shaft Rear	814812	814802	-	-	77,00	100,00		11,45		L3T SOL -Left	VMQ
047838-FP	ASTRA H-CORSA-MERİVA 1.3 CDTI EURO 4/5/6	KRANK ARKA Crank Shaft Rear	614860	55180937	20032405	428.970	78,00	100,00		9,00		F2TL SOL -Left	PTFE+ACM
047645-V	ASTRA H-CORSA-MERİVA 1.3 CDTI EURO 4/5/6	KRANK ARKA Crank Shaft Rear	614860	55180937	20032405	428.970	78,00	100,00		10,00		L13TL SOL -Left	FKM
047681-V	ASTRA F/G/H-CORSA-MERİVA-TIGRA-VECTRA-ZAFİRA-ADAM-AGILA	KRANK ARKA Crank Shaft Rear	614830	90352112	12013882	590.797	80,00	98,00		10,00		L13L SOL -Left	FKM
047910-FP	ASTRA G-H-J CORSA C VECTRA C MERİVA-COMBO-ZAFİRA 1.6 16V A16XER-Z16XER	KRANK ARKA Crank Shaft Rear	5614844	-	20034129	434.550 81-38236-00	80,00	98,00		14,60		SP F	PTFE+ACM
410503-VAE	VIVARO-VECTRA 1.4-1.9 D-2.0 DTI	KRANK ARKA Crank Shaft Rear	7703087224- 4404963-9112964	1227900QAB	20018246	711.720	85,00	105,00		6,80	11,00	L3TL SOL -Left	FKM+AEM
410386-V	VIVARO	KRANK ARKA Crank Shaft Rear	4404963	1227900QAB	12015424 20018066	508.462 81-23708-50	85,00	105,00		8,00		L3TL SOL -Left	FKM
415251-FAE	COMBO-CORSA CROSSLANDX 1.2 PURUTECH -1.0 VTI MOT.	KRANK ARKA Crank Shaft Rear	3647152	-	20037036	707.350	85,00	154,00	160,00	9,50		ETS 10	PTFE+AEM
410313-S	ASCONA DİZEL EM	KRANK ARKA Crank Shaft Rear	090 156 004	-	-	-	86,00	104,00	-	11,00	-	L3L SOL -Left	VMQ
047817-V	COMBO-ASTRA-CORSA-MERİVA-ZAFİRA-OMEGA DİZEL MOT.	KRANK ARKA Crank Shaft Rear	614825	614823	12015429	733.070	87,00	100,00		8,50		L1L SOL -Left	FKM
410359-V	ASTRA G-H-OMEGA-VECTRA-KADETT	KRANK ARKA Crank Shaft Rear	614840	90325572	20033412	694.770	90,00	104,00		11,00		L3TL SOL -Left	FKM
410507-FP	OMEGA A-B	KRANK ARKA Crank Shaft Rear	614802	614838	20019546 20033888	257.770 301.870	90,00	110,00		12,00		F25TL SOL -Left	PTFE-ACM
410453-V	MOVANO-VIVARO 2.2-2.5 DTI-G9U	KRANK ARKA Crank Shaft Rear	4403519	9111519	20028958	508.926	93,00	108,00		7,00		L3TL SOL -Left	FKM
415185-V	ASTRA J-H-VECTRA-ZAFİRA-INSIGNIA 1.6-1.9 MJET	KRANK ARKA Crank Shaft Rear	614965	-	12015763	199.191	93,00	140,00	172,00	15,00		SPL1L SOL -Left	FKM
417137-FAE	MOVANO-VIVARO 2.0-2.3 CDTI	KRANK ARKA Crank Shaft Rear	93192732	-	19036732	729.010 800.570	94,00	161,00	192,00	10,00		SPL1 SOL -Left 8	PTFE+AEM
410499-VK	CAMPO-MONTEREY-VECTRA C-FRONTERA A 3.0 MOT.	KRANK ARKA Crank Shaft Rear	614839	97071561	19019103	454.060	95,00	118,00		9,5	13,00	SC ETS1	FKM+YÜN
040692-V	VIVARO	EKSANTRİK MİLİ Cam Shaft	7703087192	M287556	12015425	508.544	25,00	42,00		8,00		L3T SAĞ -Right	FKM
041198-V	MOVANO A-VIVARO A-ASTRA H	EKSANTRİK MİLİ Cam Shaft	4403521	9111521	20019850	365.940	30,00	42,00		6,00		L3TL SAĞ -Right	FKM

MOTOR GRUBU / Engine Group

SKT NO	KULLANILAN MODELLER Models	KULLANIM YERİ Place Of Use	ORJINAL NO 1 Original No 1	ORJINAL NO 2 Original No 2	EŞDEĞER NO 1 Equivalent No 1	EŞDEĞER NO 2 Equivalent No 2	ÖLÇÜLER MM. Dimensions - MM.					TİP Type	MALZEME Material
040789-V	VECTRA-ZAFİRA	EKSANTRİK MİLİ Cam Shaft	614967	7700749395	12011839	505.838	30,00	42,00		7,00		L3T SAĞ -Right	FKM
040880-P	VECTRA C-ZAFİRA-ASTRA H 1.9 CDT-MOVANO 2.5 DTI	EKSANTRİK MİLİ Cam Shaft	614967	5973907	12010674	277.142 440.720	30,00	42,00		7,00		L3TL SAĞ -Right	ACM
041247-V	1.6-1.9-2.0 MJTD-JTDM-ASTRA H-INSIG- NIA-A VECTRA C-ZAFİRA	EKSANTRİK MİLİ Cam Shaft	5636817	-	12018345	434.500	30,00	45,00		7,00		L13TL SAĞ -Right	FKM
040815-V	ASTRA G/H/J 1.4-CORSA 1.2/1.4-MERİ- VA-VECTRA-ZAFİRA 1.4-1.6 16V	EKSANTRİK MİLİ Cam Shaft	636841	5636970	20011244	353.990 81-24909-10	35,00	48,00		7,00		L13TL SAĞ -Right	FKM
041287-V	ANTARA	EKSANTRİK MİLİ Cam Shaft	-	-	20015457 07022633	505.366	36,00	50,00		7,00		L3TL SAĞ -Right	FKM
040801-V	ASTRA-CORSA-MERİVA-OMEGA-VECTRA	EKSANTRİK MİLİ Cam Shaft	646271	646269	12014494	763.918	38,00	50,00		8,00		L13L SAĞ -Right	FKM
045990-V	MOVANO-ARENA	EKSANTRİK MİLİ Cam Shaft	4403049	9111049	12014728	419.730	55,00	70,00		8,00		L13TL SAĞ -Right	FKM
045885-V	ASTRA F-VECTRA B-KADETT-OME- GA-FRONTERA A	EKSANTRİK MİLİ Cam Shaft	638194	-	12015548	694.711	55,00	70,10		8,00		L13 SOL -Left	FKM
45-067-V	ASTRA G,H,J 1.4-CORSA 1.2/1.4-COM- BO-MERİVA VECTRA C 1.0-1.2-1.4-1.8l MOT.	SUPAP Valve Stem Seal	642500	9158057	12017224	476.691 70-34223-00	5,00	7,80	11,00	8,00		LSY2T	FKM
45-065-V	COMBO-CORSA-CROSSLAND 1.2 MOT. EP6 MOT.	SUPAP Valve Stem Seal	3645957	3553388	582.530	-	5,00	9,00	24,20	14,00		LSY5T	FKM
45-057-V	1.6-1.9-2.0 JDIT-ASTRA J-INSIGNIA-VECTRA	SUPAP Valve Stem Seal	646297	-	19037053	506.550	5,00	10,00	23,40	15,40		LSY5T	FKM
45-059-V	VIVARO 2.0 16V	SUPAP Valve Stem Seal	4409126	-	46023004	151.810	5,50	11,00	28,00	16,40		LSY5T	FKM
45-025-V	MOVANO-VİVARO-ASTRA-CORSA- OMEGA-VECTRA-ZAFİRA-ANTARA	SUPAP Valve Stem Seal	642533	4506051	12014670	724.590 70-33512-00	6,00	8,80	12,20	6,00	10,00	LSY2T	FKM
45-045-V	ASTRA-CORSA 1.3 CDTI EURO 4/5/6	SUPAP Valve Stem Seal	642504	4708615	12020107 49472889	069.630 70-33512-00	6,00	8,80	11,70	9,50		LSY2T	FKM
45-033-V	VİVARO	SUPAP Valve Stem Seal	4412186	93160891	12015802	701.289 70-26058-00	7,00	9,80	13,20	5,00	10,00	LSY2T	FKM
45-026-V	ASTRA G-F CORSA-MERİVA-OMEGA-VEC- TRA-COMBO	SUPAP Valve Stem Seal	642527	642522	12015757	586.693	7,00	11,00	16,00	7,00	10,00	LSY4T	FKM
45-021-V	VECTRA-ZAFİRA	SUPAP Valve Stem Seal	642505	095630	12014584 49472013	294.110	8,00	10,80	14,20	5,50	10,00	LSY2T	FKM
45-030-V	ARENA-MOVANO-FRONTERA	SUPAP Valve Stem Seal	4403139	9111139	12015512	143.930 104.380	8,00	12,00	15,20	5,70	9,50	LSY2T	FKM

MOTOR GRUBU / Engine Group

SKT NO	KULLANILAN MODELLER Models	KULLANIM YERİ Place Of Use	ORJINAL NO 1 Original No 1	ORJINAL NO 1 Original No 2	EŞDEĞER NO 1 Equivalent No 1	EŞDEĞER NO 1 Equivalent No 2	ÖLÇÜLER MM. Dimensions - MM.					TİP Type	MALZEME Material
4S-051-V	ARENA-MOVANO-FRONTERRA	SUPAP Valve Stem Seal	4403139	9111139	12015512	143.930 104.380	8,00	12,00	15,00	6,00	9,50	LSY2T	FKM
041056-P	COMBO-ASTRA-CORSA A-VECTRA-A-B	YAĞ POMPASI Oil Pump	646268	-	12015450	490.800	18,00	32,00		6,00		L3L SAĞ -Right	ACM
040755-P	OTOMOBİL SERİSİ	YAĞ POMPASI Oil Pump	4294592	94239173	19016593 19016666	-	28,00	40,00		8,00		L3TL SAĞ -Right	ACM
040281	EM - OLD MODELS	YAKIT POMPASI Fuel Pump	819830	-	12015322	-	17,00	28,00		7,00		L1	NBR

MOTOR CONTA GRUBU/Engine Gasket Group

SKT NO	KULLANILAN MODELLER Models	KULLANIM YERİ Place Of Use	ORJINAL NO 1 Original No 1	ORJINAL NO 1 Original No 2	EŞDEĞER NO 1 Equivalent No 1	EŞDEĞER NO 1 Equivalent No 2	ÖLÇÜLER MM. Dimensions - MM.					TİP Type	MALZEME Material
4C-005-71	ASTRA/COMBO/CORSA/CORSA C/MERİVA 1.3 CDTI (EURO4/5/6)	SİLİNDİR KAPAK CONTASI Cylinder Head Gasket	56 07 640	-	61-36210-10	414187P/ 076.356	1 çentik - 0,82mm						
4C-004-70	MOVANO 2.5 DTI	SİLİNDİR KAPAK CONTASI Cylinder Head Gasket	44 03 869	-	61-36540-00	415288P/ 517.411	1,20mm						
4C-005-72	ASTRA/COMBO/CORSA/CORSA C/MERİVA 1.3 CDTI (EURO4/5/6)	SİLİNDİR KAPAK CONTASI Cylinder Head Gasket	56 07 641	-	61-36210-20	414188P/ 076.408	2 çentik - 0,92mm						
4C-005-70	ASTRA/COMBO/CORSA/CORSA C/MERİVA 1.3 CDTI (EURO4/5/6)	SİLİNDİR KAPAK CONTASI Cylinder Head Gasket	56 07 639	-	61-36210-00	414186P/ 076.346	Çentiksiz - 0,72mm						
4C-004-30	MOVANO 2.5 DTI	ÜST TAKIM CONTA Cylinder Head Gasket Set	7701477813	-	-	-	Silindir kapak contasız						
4C-005-30	ASTRA/COMBO/CORSA/CORSA C/MERİVA 1.3 CDTI (EURO4/5/6)	ÜST TAKIM CONTA Cylinder Head Gasket Set	71744285	-	-	-	Silindir kapak contasız						
4C-005-11	ASTRA/COMBO/CORSA/CORSA C/MERİVA 1.3 CDTI (EURO4)	TAM TAKIM CONTA Full Set Gasket	71744285	71744286	-	-	FKM (VİTON) Keçeli - SKC'siz						
4C-005-10	ASTRA/COMBO/CORSA/CORSA C/MERİVA 1.3 CDTI (EURO4)	TAM TAKIM CONTA Full Set Gasket	71744285	71744286	-	-	PTFE (TEFLON) Keçeli - SKC' siz.						
4C-004-10	MOVANO 2.5 DTI	TAM TAKIM CONTA Full Set Gasket	-	-	-	-	Silindir kapak contasız						

AKS GRUBU / Axle Group

SKT NO	KULLANILAN MODELLER Models	KULLANIM YERİ Place Of Use	ORJINAL NO 1 Original No 1	ORJINAL NO 1 Original No 2	EŞDEĞER NO 1 Equivalent No 1	EŞDEĞER NO 1 Equivalent No 2	ÖLÇÜLER MM. Dimensions - MM.					TİP Type	MALZEME Material
045904	ASTRA-CORSA-TİGRA-VECTRA-ZAFİRA	ARKA AKS Rear Axle	328410	328637	1201155	043.923	40,00	52,00	62,00	8,50		SPLL3	NBR

DİFERANSİYEL GRUBU / Differential Group

SKT NO	KULLANILAN MODELLER Models	KULLANIM YERİ Place Of Use	ORJINAL NO 1 Original No 1	ORJINAL NO 1 Original No 2	EŞDEĞER NO 1 Equivalent No 1	EŞDEĞER NO 1 Equivalent No 2	ÖLÇÜLER MM. Dimensions - MM.					TİP Type	MALZEME Material
045462	RECORD	DİFERANSİYEL ÖN-MAHRUTİ Differential Front-Bevelgear	406737	-	-	-	34,00	72,00		14,50		SPL3L	NBR
045062	ASCONA-KADETT-RECORD	DİFERANSİYEL ÖN-MAHRUTİ Differential Front-Bevelgear	406745	-	-	-	45,00	60,00		10,00		L3	NBR
045744	ASCONA	DİFERANSİYEL ÖN-MAHRUTİ Differential Front-Bevelgear	724510	-	01019288	-	45,00	62,00		10,00		L1L	NBR
045883	COMBO-ASTRA-CORSA-MERİVA-VECTRA-ZAFİRA	DİFERANSİYEL SAĞ-SOL ÇIKIŞ Dif.-Right/Left Output	374197	90182165	12017376	452.500	35,00	54,00		10,00	15,00	L13TLR SS-RL	NBR
045884-V	ASTRA-VECTRA-ZAFİRA	DİFERANSİYEL SAĞ-SOL ÇIKIŞ Dif.-Right/Left Output	374514	374528 12755013	01033292	-	35,00	54,90	61,00	9,00	14,70	SPL1L SS-RL	FKM

ŞANZİMAN GRUBU / Gearbox Group

SKT NO	KULLANILAN MODELLER Models	KULLANIM YERİ Place Of Use	ORJINAL NO 1 Original No 1	ORJINAL NO 1 Original No 2	EŞDEĞER NO 1 Equivalent No 1	EŞDEĞER NO 1 Equivalent No 2	ÖLÇÜLER MM. Dimensions - MM.					TİP Type	MALZEME Material
041199-V	ASTRA F -KADETT E-VECTRA A	ŞANZİMAN ÖN Gearbox Front	714409	90542145	12017271 12011305	440.710	23,00	35,00		8,00		L13L SAĞ -Right	FKM
041292-P	ASTRA J-CORSA D-INSIGNIA A-MERİVA-VECTRA-ZAFİRA	ŞANZİMAN ÖN Gearbox Front	714952	-	1036358	-	24,50	41,00		6,00		L13TL SAĞ -Right	ACM
040465	ASCONA-KADETT-ASTRA H-VECTRA C-ZAFİRA 1.7-1.9 CDTI	ŞANZİMAN ÖN Gearbox Front	714406	5105887	12011487	038.083	25,00	35,00		7,00		L1L	NBR
040465	VECTRA-ZAFİRA	ŞANZİMAN ÖN Gearbox Front	714401	-	12011487	038.083	25,00	35,00		7,00	9,00	L1L	NBR
041288-P	ASTRA H-CORSA D-MERİVA-VECTRA C 1.3-1.7-1.9 CDTI	ŞANZİMAN ÖN Gearbox Front	714401	55180035	01033854	-	26,00	41,00		6,00		L13L SAĞ -Right	ACM

ŞANZIMAN GRUBU / Gearbox Group

SKT NO	KULLANILAN MODELLER Models	KULLANIM YERİ Place Of Use	ORJINAL NO 1 Original No 1	ORJINAL NO 1 Original No 2	EŞDEĞER NO 1 Equivalent No 1	EŞDEĞER NO 1 Equivalent No 2	ÖLÇÜLER MM. Dimensions - MM.					TİP Type	MALZEME Material
041061-V	3-5-6-323-626	ŞANZIMAN ÖN Gearbox Front	702634	94326441	19016656	-	27,00	43,00		9,00		L3TL SAĞ -Right	FKM
041235-P	FRONTERA	ŞANZIMAN ÖN Gearbox Front	702634-	94326441	19016656	-	27,00	43,00	-	9,00	-	L3L SAĞ -Right	ACM
040313	RECORD	ŞANZIMAN ARKA Gearbox Rear	724506	-	-	-	33,00	50,00		12,00		L1L	NBR
045894-P	ASTRA F-G-CORSA B-TİGRA-VECTRA B-ZAFİRA A	ŞANZIMAN ARKA-OTOMATİK Gearbox Rear-Automatic	374227	90486078	19033964	-	35,00	54,00		9,50	13,50	L3LR SS-RL	ACM
045198	ASCONA-KADETT-RECORD	ŞANZIMAN ARKA Gearbox Rear	724507	44882502	12010954	367.207	45,00	62,00		10,00		L3	NBR
045895-S	ASTRA-VECTRA-CORSA-TIGRA	ŞAN. TRİBÜN KEÇESİ Gearbox Ststem	707213	-	-	-	38,00	55,00	-	7,50	-	L12L SAĞ -Right	VMQ
040811	ASTRA F-G /CORSA A-MERIVA-TI- UGRA-VECTRA	VİTES SEÇİCİ MİLİ Gear Selection Shaft	732235	90182169	1036702	201.536	13,00	26,00		7,00		L3L	NBR
040437	VECTRA C-SIGNUM	VİTES SEÇİCİ MİLİ Gear Selection Shaft	758941	90490914	01033945	-	14,00	20,00		5,00		L2	NBR

DİREKSİYON GRUBU / Steering Group

SKT NO	KULLANILAN MODELLER Models	KULLANIM YERİ Place Of Use	ORJINAL NO 1 Original No 1	ORJINAL NO 1 Original No 2	EŞDEĞER NO 1 Equivalent No 1	EŞDEĞER NO 1 Equivalent No 2	ÖLÇÜLER MM. Dimensions - MM.					TİP Type	MALZEME Material
041134	ASTRA-VECTRA	DİREKSİYON KUTUSU Steering Box	-	-	12012530	-	19,05	34,60		6,20	9,20	L3BL	NBR
041126	VECTRA-ASTRA	DİREKSİYON KUTUSU Steering Box	0770080273	0770198130	01016544	-	20,00	30,00		5,00	6,00	L3BTL	NBR
041124	ASTRA-VECTRA	DİREKSİYON KUTUSU Steering Box	34002485	-	12014254	-	23,30	29,70		4,00		L2	NBR
041123-H	VECTRA-ASTRA	DİREKSİYON KUTUSU Steering Box	0770080436	0770198203	01016892	-	24,00	33,00		5,00		L3BTL	HNBR
041203-H	VECTRA-ASTRA	DİREKSİYON MİLİ Steering Shaft	7891033105	-	01016893	-	24,00	39,00		8,50		L3B	HNBR
041122-H	VECTRA-ASTRA	DİREKSİYON KUTUSU Steering Box	0770080436	0770198203	01019954	-	25,00	34,00		7,00		L3BT	HNBR
040844	ASTRA	DİREKSİYON MİLİ Steering Shaft	-	-	12001674	-	25,00	35,00		6,00		L3BTL	NBR

DİREKSİYON GRUBU / Steering Group

SKT NO	KULLANILAN MODELLER Models	KULLANIM YERİ Place Of Use	ORJINAL NO 1 Original No 1	ORJINAL NO 1 Original No 2	EŞDEĞER NO 1 Equivalent No 1	EŞDEĞER NO 1 Equivalent No 2	ÖLÇÜLER MM. Dimensions - MM.				TİP Type	MALZEME Material	
040845	COMMADORE	DİREKSİYON Mili Steering Shaft	902690	-	01033710	-	25,00	36,00		6,00		L3BTL	NBR
041130-H	ASTRA-VECTRA	DİREKSİYON KUTUSU Steering Box	-	-	01030096	-	25,00	37,64		6,20		L3B	HNBR
041118-H	VECTRA-ASTRA (ZF TİP KUTU)	DİREKSİYON KUTUSU Steering Box	0770080425	0770198107	01016891	-	28,00	37,00		5,00		L3BT	HNBR
041133	VECTRA-ASTRA	DİREKSİYON KUTUSU Steering Box	-	-	01015867	-	28,00	38,00		7,00		SPL3B	NBR
040849	EM	DİREKSİYON SİSTEMİ Steering System	1023361	902678	19015771	164.500	28,00	40,00		6,00		L3BTL	NBR
041321	ASTRA 1.6	HİDROLİK DİREKSİYON Steering Box	-	-	19018211	82018211	19,80	39,70		6,35		L3BTL	NBR

MOTOR GRUBU / Engine Group

SKT NO	KULLANILAN MODELLER Models	KULLANIM YERİ Place Of Use	ORJINAL NO 1 Original No 1	ORJINAL NO 2 Original No 2	EŞDEĞER NO 1 Equivalent No 1	EŞDEĞER NO 2 Equivalent No 2	ÖLÇÜLER MM. Dimensions - MM.				TİP Type	MALZEME Material	
046119-FP	PARTNER-306-307-308-406-EX- PERT-1007-2008-3008-5008 1.4-1.5-1.6 HDI	KRANK ÖN Crank Shaft Front	012742	012750	20029116	026.750	40,00	55,00		6,40		F2TL SAĞ -Right	PTFE+ACM
045968-V	PARTNER-BOXER 205-206-306-307-309- 405-407 1.9D DW8--2.0 D-HDI	KRANK ÖN Crank Shaft Front	032622	032612	20015456	508.233 040.363	42,00	62,00		7,00		L13TL SAĞ-Right	FKM
046080-V	PARTNER-106-205-206-207-307 1.4-1.6 16V TU5JP4	KRANK ÖN Crank Shaft Front	051472	0514A3	20018081	505.740 81-31863-00	42,00	66,00		6,00		L3TL SAĞ -Right	FKM
046219-FP	BOXER 3.0 MOT.	KRANK ÖN Crank Shaft Front	0514C9	-	20034876	353.780	50,00	70,00		11,00		SPFP2K SAĞ-Right	PTFE+ACM
047835-FL	BOXER 2.2 HDI	KRANK ÖN Crank Shaft Front	0514.C6	9659901780	19036447	026.782	50,00	90,00		14,00		SPF SAĞ -Right	PTFE+TPU
046210-FP	207-208-308-508-2008-3008-5008-PART- NER-RCZ	KRANK ÖN Crank Shaft Front	0514C8	9835304280	19035976	004.450	61,00	75,00		8,00		F2TL SAĞ -Right	PTFE+ACM
417107-V	BOXER 2.5-2.8 T-TD-HDI	KRANK ÖN Crank Shaft Front	0514A7	0514C1-051487	12016918	199.220	70,00	158,00	180,00	16,00		SPL1L SAĞ-Right	FKM
410386-V	106-206-207-307	KRANK ARKA Crank Shaft Rear	051474	-	12015424 20018066	508.462 81-23708-50	85,00	105,00		8,00		L3TL SOL -Left	FKM
410443-FP	PARTNER-BIPPER-206-207-307-407 1.4-1.5 HDI-1.4I 16V-1.6 HDI EURO 5	KRANK ARKA Crank Shaft Rear	017243	017249	20029117 20034738	026.790	85,00	105,00		8,80		F2TL SOL -Left	PTFE+ACM
415251-FAE	108-208-301-308-2008-3008-5008-PART- NER 1.2 PTECH -1.0VTI MOT.	KRANK ARKA Crank Shaft Rear	1609009780	16111874480	20037036	707.350	85,00	154,00	160,00	9,50		ETS 10	PTFE+AEM
410382-V	PARTNER-206-306-307-405-406-407 1.6-1.9D DW8-2.0 D	KRANK ARKA Crank Shaft Rear	012728	9614379380	20015455	508.209	90,00	110,00		7,00		L3TL SOL -Left	FKM
410341-V	J7-J9-205-305-306-405-EXPERT-PARTNER	KRANK ARKA Crank Shaft Rear	011906	012723	12013898	294.683	90,00	110,00		12,00		L13TL SOL -Left	FKM
410500-V	BOXER 3,0 HDI	KRANK ARKA Crank Shaft Rear	0514E3	0514E0	12019863	353.090	90,00	120,00		12,50	13,00	SC ETS1	FKM
417108-V	BOXER 2.5-2.8 T-TD-HDI	KRANK ARKA Crank Shaft Rear	0514A8	0514C2-051490	12016920	199.230	114,00	171,00	177,00	13,00		SPL1L SOL -Left	FKM
041265-FP	206-307-1007 1.4 16V-C2-C3-C3	EKSANTRİK MİLİ Cam Shaft	080733	-	19036292	505.600	24,00	50,00		8,00		F2TL SAĞ -Right	PTFE+ACM
041151-FP	PARTNER-BIPPER-107-206-307-308-407 1.4 HDI-1.6 HDI EURO 5	EKSANTRİK MİLİ Cam Shaft	023765	080730	20029115	026.740	27,00	47,00		7,00		F2TL SAĞ -Right	PTFE+ACM
041256-V	206-306-307-308-406-407-508-3008-BOX- ER-EXPERT-PARTNER 2.0-2.2 HDI	EKSANTRİK MİLİ Cam Shaft	080728	-	20026123	153.740	27,00	47,00		7,00		L3TL SAĞ -Right	FKM
045844-P	EXPERT	EKSANTRİK MİLİ Cam Shaft	102407	40004460	12015854	332.220 440.750	30,00	52,00		7,00		L13TL SAĞ-Right	ACM

MOTOR GRUBU / Engine Group

SKT NO	KULLANILAN MODELLER Models	KULLANIM YERİ Place Of Use	ORJINAL NO 1 Original No 1	ORJINAL NO 2 Original No 2	EŞDEĞER NO 1 Equivalent No 1	EŞDEĞER NO 2 Equivalent No 2	ÖLÇÜLER MM. Dimensions - MM.					TİP Type	MALZEME Material
040946-V	EXPERT	EKSANTRİK MİLİ Cam Shaft	068103085E	026103085A	01019928	325.155 325.156	32,00	47,00		10,00		L3TL SS- RL	FKM
040747-V	BOXER-PARTNER-206-306- 1.9 D DW8-2.5 TD-TDI	EKSANTRİK MİLİ Cam Shaft	080714	-	20018100	757.292	35,00	50,00		7,00		L3TL SAĞ -Right	FKM
040740-V	205-306-405-406-BOXER	EKSANTRİK MİLİ Cam Shaft	023614	023615	19026017	-	35,00	50,00		8,00		L3TL SAĞ -Right	FKM
041287-V	106-206-207-305-306-307-406-407-BOX- ER-BIPPER-PARTNER	EKSANTRİK MİLİ Cam Shaft	023644-023621	97510802	20015457 07022633	505.366	36,00	50,00		7,00		L3TL SAĞ -Right	FKM
041293-FP	106-206-207-307-1007-BIPPER-PARTNER 1.1-1.4I 16V MOT.	EKSANTRİK MİLİ Cam Shaft	080732	-	19036293	505.100	36,00	50,00		8,00		F2TL SAĞ -Right	PTFE+ACM
041250-V	106-206-307-308-406-605-PARTNER 1.6 16V TU5JP4	EKSANTRİK MİLİ Cam Shaft	080724	-	20018317	135.140 81-34146-00	38,00	50,00		6,00		L3TL SAĞ -Right	FKM
046217-V	206-307-406-407-EXPERT	EKSANTRİK MİLİ Cam Shaft	032627	-	12016528 46085500	290.710	40,00	55,00		7,00		L13TL SAĞ -Right	FKM
045898-V	EXPERT 1.6	EKSANTRİK MİLİ Cam Shaft	051478	46425764	12015853	440.760	40,00	56,00		7,00		L13TL SAĞ -Right	FKM
045728-P	J7-J9-304-504-505	EKSANTRİK MİLİ Cam Shaft	0514.11	1612236	07011550 19015085	040.320	42,00	60,00		8,00		L3T SAĞ -Right	ACM
045990-V	BOXER 2.5-2.8 D-HDI	EKSANTRİK MİLİ Cam Shaft	080729	98427998	12014728	419.730	55,00	70,00		8,00		L13TL SAĞ -Right	FKM
45-065-V	207-208-308-3008-5008-1.2 MOT. EP6 MOT.	SUPAP Valve Stem Seal	1611289780	1611510280	582.530	-	5,00	9,00	24,20	14,00		LSY5T	FKM
45-047-V	206-207-307-PARTNER-EXPERT 1.6 HDI	SUPAP Valve Stem Seal	095651	1229886	19035752	262.650	5,50	9,50	18,10	11,00	14,00	LSY5T	FKM
45-048-V	206-207-301-308-3008 1.4 HDI-1.5 HDI-1.6 HDI EURO5	SUPAP Valve Stem Seal	095650	1145937	19035539	027.750	5,50	9,50	22,90	14,00	17,50	LSY5T	FKM
45-025-V	106-206-207-307-406-605-607-1007-EX- PERT-PARTNER 1.6 16V TU5JP4	SUPAP Valve Stem Seal	095638	095640	12051545	724.590 70-33512-00	6,00	8,80	12,20	6,00	10,00	LSY2T	FKM
45-068-V	206-306-307-308-406-407-BOXER-EX- PERT-PARTNER 2.0 HDI DW10	SUPAP Valve Stem Seal	095648	-	12016913	136.940	6,00	10,00	19,60	21,50		LSY5T	FKM
45-033-V	106-205-206-207-306-307-405-PART- NER-BOXER	SUPAP Valve Stem Seal	095628	095624-098628	12015802	701.289 70-26058-00	7,00	9,80	13,20	5,00	10,00	LSY2T	FKM
45-031-V	BOXER 2.2 HDI EURO 5	SUPAP Valve Stem Seal	0956.59	1096253	19036760	027.740	7,00	12,00	24,15	13,80	18,60	LSY6T	FKM
45-021-V	PARTNER-106-205-206-306-405-605-J9- BOXER 1.9 D- DW8	SUPAP Valve Stem Seal	095622	095631	12014584 49472013	294.110	8,00	10,80	14,20	5,50	10,00	LSY2T	FKM

MOTOR GRUBU / Engine Group

SKT NO	KULLANILAN MODELLER Models	KULLANIM YERİ Place Of Use	ORJINAL NO 1 Original No 1	ORJINAL NO 1 Original No 2	EŞDEĞER NO 1 Equivalent No 1	EŞDEĞER NO 1 Equivalent No 2	ÖLÇÜLER MM. Dimensions - MM.					TİP Type	MALZEME Material
45-046-V	206-207-307-1007-1.4 16V	SUPAP Valve Stem Seal	095652	-	12019283 49472886	505.470	5,5	10,53	21,60	11,00	15,50	LSYST	FKM
040939-V	J7-J9	VAKUM POMPASI Vacuum Pump	-	-	-	-	17,00	32,00		7,00		L3BT SAĞ -Right	FKM
046221-P	BOXER III	VAKUM POMPASI Vacuum Pump	4570.18	-	-	-	65,00	70,00		9,00		SPCL	ACM
041296-P	BOXER III 2.2 HDI	MOT.ÜST KAP.CIVATA KEÇESİ Engine Valve Cover Bolts	BK3Q9T529AB	0249E8	-	-	7,50	18,00	23,00	6,20	8,00	SPL3T	ACM
041274-P	206-207-307-308-407-1007-3008 EX- PERT-PARTNER DV6 MOT.	ENJEKTÖR GÖVDE KEÇESİ Injector Body Seal	1982.A0	-	734.960	-	18,00	29,00		6,00		L2T	ACM

MOTOR CONTA GRUBU/Engine Gasket Group

SKT NO	KULLANILAN MODELLER Models	KULLANIM YERİ Place Of Use	ORJINAL NO 1 Original No 1	ORJINAL NO 2 Original No 2	EŞDEĞER NO 1 Equivalent No 1	EŞDEĞER NO 2 Equivalent No 2	ÖLÇÜLER MM. Dimensions - MM.	TİP Type	MALZEME Material
4C-011-70	307/407/PARTNER 1.6 HDI	SİLİNDİR KAPAK CONTASI Cylinder Head Gasket	0209.CE	-	-	414114P/ 569.802	1 çentik - 1,35mm		
4C-011-71	307/407/PARTNER 1.6 HDI	SİLİNDİR KAPAK CONTASI Cylinder Head Gasket	0209.CA	-	61-36265-00	414112P/ 569.812	2 çentik - 1,25mm		
4C-011-72	307/407/PARTNER 1.6 HDI	SİLİNDİR KAPAK CONTASI Cylinder Head Gasket	0209.CC	-	-	414113P/ 569.820	3 çentik - 1,30mm		
4C-015-72	1.6 HDI EURO5 MOTORLAR 1.6 HDI (EURO5)	SİLİNDİR KAPAK CONTASI Cylinder Head Gasket	0209. JH	-	61-37940-20	49409418	4 çentik - 1,35mm		
4C-011-73	307/407/PARTNER 1.6 HDI	SİLİNDİR KAPAK CONTASI Cylinder Head Gasket	0209.CF	-	-	414115P/ 569.832	4 çentik - 1,40mm		
4C-015-70	1.6 HDI, EURO5 MOTORLAR 1.6 HDI (EURO5)	SİLİNDİR KAPAK CONTASI Cylinder Head Gasket	0209. JF	-	61-37940-00	49409416	5 çentik - 1,25mm		
4C-011-74	307/407/PARTNER 1.6 HDI	SİLİNDİR KAPAK CONTASI Cylinder Head Gasket	0209.CG	-	-	414116P/ 569.842	5 çentik - 1,45mm		
4C-015-71	1.6 HDI, EURO5 MOTORLAR 1.6 HDI (EURO5)	SİLİNDİR KAPAK CONTASI Cylinder Head Gasket	0209. JG	-	61-37940-10	49409417	6 çentik - 1,30mm		
4C-015-73	1.6 HDI EURO5 MOTORLAR 1.6 HDI (EURO5)	SİLİNDİR KAPAK CONTASI Cylinder Head Gasket	0209. JJ	-	61-37940-30	49409419	7 çentik - 1,40mm		
4C-015-74	1.6 HDI, EURO5 MOTORLAR 1.6 HDI (EURO5)	SİLİNDİR KAPAK CONTASI Cylinder Head Gasket	0209JK	-	61-37940-40	49409490	8 çentik - 1,45mm		
4C-014-70	BOXER 2.2 HDI	SİLİNDİR KAPAK CONTASI Cylinder Head Gasket	0209. EH	-	61-37365-00	415592P/ 156.201	1 çentik - 1,10mm		
4C-009-70	PARTNER (7/1998=>) 1.9 D (DW8)	SİLİNDİR KAPAK CONTASI Cylinder Head Gasket	0209.X0	-	61-33720-00	415032P/ 130.642	1 çentik - 1,26mm		
4C-010-70	107/206/207/208/307 1.4 HDI	SİLİNDİR KAPAK CONTASI Cylinder Head Gasket	0209.AF	-	61-35430-20	414109P/ 100.420	1 çentik - 1,35mm		
4C-014-71	BOXER 2.2 HDI	SİLİNDİR KAPAK CONTASI Cylinder Head Gasket	0209. ES	-	61-37365-10	415593P/ 156.211	2 çentik - 1,15mm		
4C-010-71	107/206/207/208/307 1.4 HDI	SİLİNDİR KAPAK CONTASI Cylinder Head Gasket	0209.AC	-	61-35430-00	414107P/ 100.400	2 çentik - 1,25mm		
4C-009-71	PARTNER (7/1998=>) 1.9 D (DW8)	SİLİNDİR KAPAK CONTASI Cylinder Head Gasket	0209.X1	-	61-33720-10	415033P/ 130.652	2 çentik - 1,30mm		

MOTOR CONTA GRUBU/Engine Gasket Group

SKT NO	KULLANILAN MODELLER Models	KULLANIM YERİ Place Of Use	ORJINAL NO 1 Original No 1	ORJINAL NO 2 Original No 2	EŞDEĞER NO 1 Equivalent No 1	EŞDEĞER NO 2 Equivalent No 2	ÖLÇÜLER MM. Dimensions - MM.	TİP Type	MALZEME Material
4C-014-72	BOXER 2.2 HDI	SİLİNDİR KAPAK CONTASI Cylinder Head Gasket	0209.ET	-	61-37365-20	415594P/ 156.221	3 çentik - 1,20mm		
4C-010-72	107/206/207/208/307 1.4 HDI	SİLİNDİR KAPAK CONTASI Cylinder Head Gasket	0209.AE	-	61-35430-10	414108P/ 100.410	3 çentik - 1,30mm		
4C-009-72	PARTNER (7/1998=>) 1.9 D (DW8)	SİLİNDİR KAPAK CONTASI Cylinder Head Gasket	0209.X2	-	61-33720-20	415034P/ 130.662	3 çentik - 1,34mm		
4C-009-73	PARTNER (7/1998=>) 1.9 D (DW8)	SİLİNDİR KAPAK CONTASI Cylinder Head Gasket	0209.X3	-	61-33720-30	415035P/ 130.672	4 çentik - 1,38mm		
4C-010-73	107/206/207/208/307 1.4 HDI	SİLİNDİR KAPAK CONTASI Cylinder Head Gasket	0209.AG	-	61-35430-30	414110P/ 100.430	4 çentik - 1,40mm		
4C-009-74	PARTNER (7/1998=>) 1.9 D (DW8)	SİLİNDİR KAPAK CONTASI Cylinder Head Gasket	0209.X4	-	61-33720-40	415036P/ 130.682	5 çentik - 1,42mm		
4C-010-74	107/206/207/208/307 1.4 HDI	SİLİNDİR KAPAK CONTASI Cylinder Head Gasket	0209.AH	-	61-35430-40	414111P/ 100.440	5 çentik - 1,45mm		
4C-010-30	107/206/207/208/307 1.4 HDI	ÜST TAKIM CONTA Cylinder Head Gasket Set	-	-	-	-	Silindir kapak contasız		
4C-011-30	307/407/PARTNER 1.6 HDI	ÜST TAKIM CONTA Cylinder Head Gasket Set	-	-	-	-	Silindir kapak contasız		
4C-015-30	1.5 HDI/1.6 HDI EURO5 MOTORLAR 1.5 HDI/1.6 HDI (EURO5)	ÜST TAKIM CONTA Cylinder Head Gasket Set	-	-	-	-	Silindir kapak contasız		
4C-009-10	PARTNER (7/1998=>) 1.9 D (DW8)	TAM TAKIM CONTA Full Set Gasket	0197.X6	-	-	-	Silindir kapak contasız		
4C-010-10	107/206/207/208/307 1.4 HDI	TAM TAKIM CONTA Full Set Gasket	-	-	-	-	Silindir kapak contasız		
4C-011-10	307/407/PARTNER 1.6 HDI	TAM TAKIM CONTA Full Set Gasket	-	-	-	-	Silindir kapak contasız		
4C-014-10	BOXER 2.2 HDI	TAM TAKIM CONTA Full Set Gasket	-	-	-	-	Silindir kapak contasız		
4C-015-10	1.5 HDI/1.6 HDI EURO5 MOTORLAR 1.5 HDI/1.6 HDI (EURO5)	TAM TAKIM CONTA Full Set Gasket	-	-	-	-	Silindir kapak contasız		

AKS GRUBU / Axle Group

SKT NO	KULLANILAN MODELLER Models	KULLANIM YERİ Place Of Use	ORJINAL NO 1 Original No 1	ORJINAL NO 1 Original No 2	EŞDEĞER NO 1 Equivalent No 1	EŞDEĞER NO 1 Equivalent No 2	ÖLÇÜLER MM. Dimensions - MM.					TİP Type	MALZEME Material
047739	BOXER	ÖN AKS İÇ-DİŞ Front Axle Inner-Outer	334617	334621	12015943	663P	70,00	90,00		13,50		L1L	NBR
047740	J7-J9	ÖN AKS Front Axle	7930001905	-	12017075	-	75,00	95,00		8,00		L3	NBR
047575	J7-J9	ARKA AKS Rear Axle	3723.06	373306	12010985	-	55,00	80,00		8,00		L3	NBR
045991	BOXER 2.0-2.5-2.8 D-TD-TDI-HDI	ARKA AKS Rear Axle	372432	372443	12014086	-	58,00	75,00		14,00	15,50	L13TL	NBR
4TM-053	J7-J9	FREN HİD.MRKZ.SİLİNDİRİ Brake Hyd.Cylinder	-	-	-	-						TM	-

DİFERANSİYEL GRUBU / Differential Group

SKT NO	KULLANILAN MODELLER Models	KULLANIM YERİ Place Of Use	ORJINAL NO 1 Original No 1	ORJINAL NO 1 Original No 2	EŞDEĞER NO 1 Equivalent No 1	EŞDEĞER NO 1 Equivalent No 2	ÖLÇÜLER MM. Dimensions - MM.					TİP Type	MALZEME Material
046234-V	206-207-208-306-307-308-406-407-2008-EXPERT 1.9	DİFERANSİYEL SAĞ ÇIKIŞ Dif.-Right Output	312142	-	20026878	NA5490	27,94	56,00		8,00		L3TL SAÇ -Right	FKM
040883-P	PARTNER-106-206-306-307-405-406-407-EXPERT	DİFERANSİYEL SAĞ ÇIKIŞ Dif.-Right Output	312126	-	20015497	128.240	29,85	47,00		11,30		L3TL SAÇ -Right	ACM
041276-PF	PARTNER-106-206-306-307-405-406-407-EX- PERT-305	DİFERANSİYEL SAĞ ÇIKIŞ Dif.-Right Output	312110	-	07011583	15007900	29,85	47,00		11,30		L3TL SAÇ -Right	ACM

DİFERANSİYEL GRUBU / Differential Group

SKT NO	KULLANILAN MODELLER Models	KULLANIM YERİ Place Of Use	ORJINAL NO 1 Original No 1	ORJINAL NO 1 Original No 2	EŞDEĞER NO 1 Equivalent No 1	EŞDEĞER NO 1 Equivalent No 2	ÖLÇÜLER MM. Dimensions - MM.					TİP Type	MALZEME Material
041141-P	PARTNER-106-206-306-307-405-406-407-BIPPER-EXPERT	DİFERANSİYEL SAĞ ÇIKIŞ Dif.-Right Output	312146	312147	20028963	505.090	29,90	47,00		11,30		L3TL SAĞ -Right	ACM
045995-V	BOXER-605 2.0-2.2-2.5-2.8 TD-TDI-HDI	DİFERANSİYEL SAĞ ÇIKIŞ Dif.-Right Output	301028	9616785780	07019090	381.710	34,90	54,00		11,30		L3TL SAĞ -Right	FKM
046238-PF	206-207-208-306-307-308-406-407-EX- PERT	DİFERANSİYEL SOL ÇIKIŞ Differential Left Output	312164	-	20034245	-	40,00	54,00		6,80		SPL3TL SOL-Left	ACM+ PTFE
046240-VAE	PARTNER-106-206-306-307-405-406-407- EXPERT	DİFERANSİYEL SOL ÇIKIŞ Differential Left Output	312140	-	20026877	-	40,00	54,00		6,80		L3TL SOL -Left	FKM+AEM
047872-P	106-206-306-406-407-EXPERT-PARTNER 1.4-1.6 I 16V	DİFERANSİYEL SOL ÇIKIŞ Differential Left Output	312127	96080067	07015496	128.250	40,00	58,00		11,30		SPL13T- LLSS-RL	ACM
046181-PF	106 1.4 / 206 1.4 - 1.6 16V / 306 1.4-1.6 / PARTNER 1.9D - 2.0HDI	DİFERANSİYEL SOL ÇIKIŞ Differential Left Output	312127	-	7015496	128.250	40,00	58,00	-	11,30	-	SPL3TL SOL-Left	ACM+ PTFE
045994-V	BOXER-605 2.0-2.5-TD-TDI-HDI	DİFERANSİYEL SOL ÇIKIŞ Differential Left Output	301027	-	07019089	381.690	43,00	59,00		10,00		L3TL SOL- Left	FKM
046220-VL	605-BOXER	DİFERANSİYEL SOL ÇIKIŞ Differential Left Output	301027	-	07019089	381.690	43,00	59,00		10,00		SPL3TL SOL-Left	FKM+TPU
045626	J7-J9	DİFERANSİYEL SAĞ-SOL ÇIKIŞ Dif.-Right/Left Output	3287.31	-	01029158	-	35,00	52,00		10,00	13,00	L3L	NBR
045884-V	BOXER	DİFERANSİYEL SAĞ-SOL ÇIKIŞ Dif.-Right/Left Output	71734264	55707298	01033292	-	35,00	54,90	61,00	9,00	14,70	SPL1L SS-RL	FKM
046123-VP	BOXER-PARTNER-106-206-207-307-2008- 3008-5008-EXPERT-BIPPER 1.4-1.6 HDI	DİFERANSİYEL SAĞ-SOL ÇIKIŞ Differential Right-Left Output	312123	236210	20020137	504.581	40,00	58,00		10,00		L3TL SS-RL	FKM
046237-P	BOXER 115 MULTIJET 2,0 D-3.0 D	DİFERANSİYEL SAĞ-SOL ÇIKIŞ Dif.-Right/Left Output	312160	-	01034875	-	45,00	64,85	71,20	8,90	14,70	SPL13TL SS-RL	ACM

ŞANZIMAN GRUBU / Gearbox Group

SKT NO	KULLANILAN MODELLER Models	KULLANIM YERİ Place Of Use	ORJINAL NO 1 Original No 1	ORJINAL NO 1 Original No 2	EŞDEĞER NO 1 Equivalent No 1	EŞDEĞER NO 1 Equivalent No 2	ÖLÇÜLER MM. Dimensions - MM.					TİP Type	MALZEME Material
040884	PARTNER-206-306-307-406-407 1.9-1.6 D-HDI	ŞANZIMAN ÖN Gearbox Front	210940	-	07015547	131.860	23,00	36,00		7,00		L3TL SAĞ -Right	NBR
041268-P	308-508-407-508-607-3008-5008-EX- PERT-TRAVELLER	ŞANZIMAN ÖN Gearbox Front	210962	-	07034872	-	26,80	41,00		9,20		SPL3TL SAĞ-Right	ACM
040623	J7-J9	ŞANZIMAN ÖN Gearbox Front	2302.04	-	12010871	-	27,00	42,00		9,80		L3	NBR

ŞANZIMAN GRUBU / Gearbox Group

SKT NO	KULLANILAN MODELLER Models	KULLANIM YERİ Place Of Use	ORJINAL NO 1 Original No 1	ORJINAL NO 1 Original No 2	EŞDEĞER NO 1 Equivalent No 1	EŞDEĞER NO 1 Equivalent No 2	ÖLÇÜLER MM. Dimensions - MM.				TİP Type	MALZEME Material	
040756	C5	ŞANZIMAN ÖN Gearbox Front	10	-	12000135	12011030	28,00	47,00		7,00		L3L	NBR
045361	J7-J9-504	ŞANZIMAN ARKA Gearbox Rear	3121.03	-	12010908	258.407	35,00	52,00		10,00		L3L	NBR
045198	OTOMOBİL SERİSİ	ŞANZIMAN ARKA Gearbox Rear	335410	-	12010954	367.207	45,00	62,00		10,00		L3	NBR
040261	JUMPER	ŞANZ. KLM ÇIKIŞ MİLİ Speedometer Shaft	265104	9750254580	46081904	-	8,00	16,00		7,00		L3	NBR
041060-P	BOXER 2.5 D-TD-TDI	VİTES SEÇİCİ MİLİ Gear Selection Shaft	254116	9616785580	07019091	-	18,00	28,00		6,50		L3TL	ACM

DİREKSİYON GRUBU / Steering Group

SKT NO	KULLANILAN MODELLER Models	KULLANIM YERİ Place Of Use	ORJINAL NO 1 Original No 1	ORJINAL NO 1 Original No 2	EŞDEĞER NO 1 Equivalent No 1	EŞDEĞER NO 1 Equivalent No 2	ÖLÇÜLER MM. Dimensions - MM.				TİP Type	MALZEME Material	
041201	BİNEK GRUBU	DİREKSİYON MİLİ Steering Shaft	-	-	12015526	-	19,05	34,60		4,40	5,90	L3BTL	NBR
041134	BOXER	DİREKSİYON KUTUSU Steering Box	-	-	12012530	-	19,05	34,60		6,20	9,20	L3BL	NBR
041126	PARTNER-206	DİREKSİYON KUTUSU Steering Box	0770080273	0770198130	01016544	-	20,00	30,00		5,00	6,00	L3BTL	NBR
041119	PARTNER	DİREKSİYON KUTUSU Steering Box	-	-	19017090	-	22,00	32,00		7,00		L3BL	NBR
041229-HL	OTOMOBİL SERİSİ	DİREKSİYON SİSTEMİ Steering System	-	-	-	-	23,00	32,60	-	5,50	8,00	SPL3B	HNBR+TPU
041124	BOXER	DİREKSİYON KUTUSU Steering Box	-	-	12014254	-	23,30	29,70		4,00		L2	NBR
040519	J7	DİREKSİYON MİLİ Steering Shaft	217018	2982310	12011123	-	25,00	40,00		8,00		L3L	NBR
041127-H	BOXER	DİREKSİYON MİLİ Steering Shaft	-	-	15019947	-	30,00	42,50		6,50		L3BT	HNBR
041228-HL	OTOMOBİL SERİSİ	DİREKSİYON SİSTEMİ Steering System	-	-	-	-	30,00	42,50	49,00	7,40	10,90	SPL3BT	HNBR+TPU
041212-NL	OTOMOBİL SERİSİ	DİREKSİYON KUTUSU Steering Box	7891033104	-	01019952	-	24,00	37,00		8,50		L3BTL	NBR+TPU

DİREKSİYON GRUBU / Steering Group

SKT NO	KULLANILAN MODELLER Models	KULLANIM YERİ Place Of Use	ORJINAL NO 1 Original No 1	ORJINAL NO 1 Original No 2	EŞDEĞER NO 1 Equivalent No 1	EŞDEĞER NO 1 Equivalent No 2	ÖLÇÜLER MM. Dimensions - MM.					TİP Type	MALZEME Material
041204-H	BİNEK GRUBU	DİREKSİYON KUTUSU Steering Box	7891033104	-	01019952	-	24,00	37,00		8,50		L3B	HNBR
041317-HL	206-306-307-308-508	HİDROLİK DİREKSİYON Steering Box	963665808A	-	01029602	82029602	24,00	36,00	37,00	8,50	17,70	SPL13BTL	HNBR+TPU
040903	407	DİREKSİYON KUTUSU Steering Box	-	-	19019968	-	28,00	43,00		6,50		SPL3B	NBR

MOTOR GRUBU / Engine Group

SKT NO	KULLANILAN MODELLER Models	KULLANIM YERİ Place Of Use	ORJINAL NO 1 Original No 1	ORJINAL NO 2 Original No 2	EŞDEĞER NO 1 Equivalent No 1	EŞDEĞER NO 2 Equivalent No 2	ÖLÇÜLER MM. Dimensions - MM.				TİP Type	MALZEME Material
041282-V	CLIO-KANGOO-TWINGO 1.2 16V MOT.	KRANK ÖN Crank Shaft Front	7700873534	-	12025770	050.540	32,00	44,00		6,00	L3TL SAĞ -Right	FKM
041283-FP	CLIO -KANGOO-MODUS-SYMBOL-TWINGO 1.2 16V	KRANK ÖN Crank Shaft Front	7701473494	-	20029612	169.620	32,00	44,00		6,00	F2TL SAĞ -Right	PTFE+ACM
041114-V	CLIO-MEGANE-EKSPRES-KANGOO -LAGUNA-K4M	KRANK ÖN Crank Shaft Front	7700273776	1351000AQQ	20019851	336.999	35,00	47,00		6,00	L3TL SAĞ -Right	FKM
041116-FP	CLIO-KANGOO-MEGANE-SCENIC-SYMBOL-TWINGO 1.5 DCİ-K4M-K4J-1.4-1.6 16V	KRANK ÖN Crank Shaft Front	7701475009	7701473545	20034106	431.420	35,00	47,00		7,00	F2TL SAĞ -Right	PTFE+ACM
040816-V	MASTER-TRAFIC-CLIO-MEGANE-SCENIC-SEMBOL- K7M MOT. 1.6 I-1.5 DCİ	KRANK ÖN-EKSANTRİK MİLİ Crank Shaft Front-Cam Shaft	7700854842	7700619237	12013859	336.998	35,00	47,00		7,00	L3TL SAĞ -Right	FKM
040329	12 TOROS	KRANK ÖN Crank Shaft Front	6000046488	-	-	-	35,00	50,00		8,00	L3 SAĞ -Right	NBR
040329-S	12 TOROS	KRANK ÖN Crank Shaft Front	7700627112	7700522314	15013000	293.946	35,00	50,00		8,00	L3 SAĞ -Right	VMQ
040740-V	12 TOROS-R19	KRANK ÖN Crank Shaft Front	7700859691	90501721	12016927	-	35,00	50,00		8,00	L3TL SAĞ -Right	FKM
040831-V	TWINGO	KRANK ÖN Crank Shaft Front	7700859691	90501721	12013459	293.946	35,00	50,00		8,00	L13TL SAĞ-Right	FKM
046007-V	MASTER-TRAFIC-KANGOO-CLIO-MEGANE-LAGUNA 1.9 DTI-DCİ	KRANK ÖN Crank Shaft Front	7700103245	6001545287	12018755	157.200 981.480	42,00	54,00		6,00	L3TL SAĞ -Right	FKM
045776-V	EXPRESS-MEGANE-CLIO-SAFRANE-R9-11-19-21-25	KRANK ÖN Crank Shaft Front	7700866877	7700619239	12013865	508.470	50,00	68,00		10,00	L3TL SAĞ -Right	FKM
047908-FAEL	KADJAR-KALEOS-LAGUNA-MEGANE -TRAFIC-1.6 DCİ-2.0 DCİ-MASTER 2.5 -	KRANK ÖN Crank Shaft Front	7701476858	-	19036731	260.320	50,00	81,00		11,50	SPF SAĞ -Right	PTFE+ AEM+TPU
046158-VP	MASTER-TRAFIC-LAGUNA 2.2-2.5 DCİ-G9U	KRANK ÖN Crank Shaft Front	7700103945	4403530	46085509	505.110	60,00	75,00		7,00	L3TL SAĞ -Right	FKM
417107-V	MASTER-TRAFIC 2.5-2.8 D-DTI	KRANK ÖN Crank Shaft Front	7701044093	5001865740	12016918	199.220	70,00	158,00	180,00	16,00	SPL1L SAĞ-Right	FKM
047903-V	CLIO I-2-3-4-KANGOO-MODUS-TWINGO 1.2 MOT.	KRANK ARKA Crank Shaft Rear	7700874223	-	20025741	050.550	70,00	86,00		7,00	L3TL SOL -Left	FKM
047904-FP	CLIO -KANGOO-MODUS-SYMBOL-TWINGO 1.2 MOT.	KRANK ARKA Crank Shaft Rear	7701473493	-	20029611	169.650	70,00	86,00		7,00	F2TL SOL -Left	PTFE+ACM
047049-S	12 TOROS	KRANK ARKA Crank Shaft Rear	7703087036	7700517058	12014736	513.326	70,00	90,00		10,00	L3 SOL -Left	VMQ
047843-V	12 TOROS	KRANK ARKA Crank Shaft Rear	7700517058	7703087036	16012790 12014736	513.326	70,00	90,00		10,00	L3T SOL -Left	FKM

MOTOR GRUBU / Engine Group

SKT NO	KULLANILAN MODELLER Models	KULLANIM YERİ Place Of Use	ORJINAL NO 1 Original No 1	ORJINAL NO 2 Original No 2	EŞDEĞER NO 1 Equivalent No 1	EŞDEĞER NO 2 Equivalent No 2	ÖLÇÜLER MM. Dimensions - MM.				TİP Type	MALZEME Material	
047225	R5	KRANK ARKA Crank Shaft Rear	90407590	-	12000367	-	75,00	90,00		8,00		L3	NBR
047650-V	CLIO-KANGOO-LAGUNA-EKSPRES-9-19-25-SCENIC 1.4-1.6 16V-1.5 DCI-K4M-K4J-K4K	KRANK ARKA Crank Shaft Rear	7700859692	7700743161	12015352	128.210 81-18304-50	80,00	100,00		8,00		L3TL SOL -Left	FKM
047832-FP	CLIO-KANGOO-MEGANE-MASTER-FLU-ENCE-SCENIC-SEMBOL-1.5 DCI	KRANK ARKA Crank Shaft Rear	7701473544	8200043463	20030112 19034107	745.740	80,00	100,00		9,00		F2TL SOL -Left	PTFE+ ACM
047475-S	9-11-12	KRANK ARKA Crank Shaft Rear	7703087080	7703087035	19030094	128.210	80,00	100,00		13,00		L3 SOL -Left	VMQ
410497-V	CLIO3-G.SCENIC-LAGUNA-MEGANE III	KRANK ARKA Crank Shaft Rear	12279ED000	7701065057	19034989	471.060	84,00	117,00		8,50		L3TL SOL -Left	FKM
410503-VAE	TRAFIC-KANGO-MEGANE-LAGUNA-1.8 16V-1.9 DCI-2.0 16V	KRANK ARKA Crank Shaft Rear	7703087224 4404963	1227900QAB 9112963	20018246	711.720	85,00	105,00		6,80	11,00	L3TL SOL -Left	FKM+AEM
410386-V	MEGANE-KANGOO-MASTER-TRAFIC-CLIO-1.9-DCI-DTI-D	KRANK ARKA Crank Shaft Rear	7703087224	1227900QAB	12015424 20018066	508.462 81-23708-50	85,00	105,00		8,00		L3TL SOL -Left	FKM
410276-S	9-11-19-21	KRANK ARKA Crank Shaft Rear	7700595940	7700714701	12012347	-	85,00	105,00		12,00		L3TL SOL -Left	VMQ
410276-V	9-11-19-21	KRANK ARKA Crank Shaft Rear	7700695940	7700695940	12012347 20018246	508-462 81-23708-50	85,00	105,00		12,00		L3TL SOL -Left	FKM
410453-V	MASTER-TRAFIC-LAGUNA 19-21 2.2-2.5 DCI-G9U	KRANK ARKA Crank Shaft Rear	7700859266	4403519	20018713	508.926	93,00	108,00		7,00		L3TL SOL -Left	FKM
417137-FAE	SCENIC-KADJAR-KALEOS-LAGUNA-MEGANE-TRAFIC 1.6 DCI-2.0/2.0 DCI	KRANK ARKA Crank Shaft Rear	7701476859	-	19036732	729.010 800.570	94,00	161,00	192,00	10,00		SPL1 SOL -Left 8	PTFE+ AEM
410499-VK	VEL SATIS-ESPACE 3,0 MOT.	KRANK ARKA Crank Shaft Rear	7701052672	-	19019103	454.060	95,00	118,00		9,5	13,00	SC ETS1	FKM+YÜN
417108-V	MASTER-TRAFIC 2.5-2.8 D-DTI	KRANK ARKA Crank Shaft Rear	7701044692	7701044092	12016920	199.230	114,00	171,00	177,00	13,00		SPL1L SOL-Left	FKM
040699-S	19-21	EKSANTRİK MİLİ-ARKA Cam Shaft-Rear	7700718598	7700742021	20015738	508.608	22,00	45,00		8,00		L3 SOLü- Left	VMQ
040692-V	MEGANE-LAGUNA-KANGO-EKSPRES-TRAFİC-MASTER	EKSANTRİK MİLİ Cam Shaft	7700714702	7700725410	12013862	-	25,00	42,00		8,00		L3T SAĞ -Right	FKM
041115-V	CLIO-KANGOO-MEGANE-SCENIC-SYMBOL-LAGUNA-K4M-K4J-1.4 16V-1.5 DCI =>2004	EKSANTRİK MİLİ Cam Shaft	7701471376	13042BN700	12018754	073.890	28,00	42,00		5,00		L3TL SAĞ -Right	FKM
041278-FP	CLIO-KANGOO-MEGANE-CAPTUR-SYMBOL-1.5-1.6 DCI EURO 5-K4M 716-760	EKSANTRİK MİLİ Cam Shaft	7701474149	8200079247	20035460	584.880 81-38506-00	28,00	42,00		6,00		F2TL SAĞ -Right	PTFE+ ACM
041281-FP	CLIO -KANGOO-MODUS-SYMBOL-TWINGO 1.2 16V D4F 732-740	EKSANTRİK MİLİ Cam Shaft	7701473495	-	20027969	159.714	28,00	47,00		8,00		F2TL SAĞ -Right	PTFE+ ACM

MOTOR GRUBU / Engine Group

SKT NO	KULLANILAN MODELLER Models	KULLANIM YERİ Place Of Use	ORJINAL NO 1 Original No 1	ORJINAL NO 2 Original No 2	EŞDEĞER NO 1 Equivalent No 1	EŞDEĞER NO 2 Equivalent No 2	ÖLÇÜLER MM. Dimensions - MM.					TİP Type	MALZEME Material
040695-P	CLIO-KANGOO-MODUS 1.2 16V	EKSANTRİK MİLİ Cam Shaft	7701473495	7701473495	20027969	159.714	28,00	47,00		8,00		L3L SAĞ -Right	ACM
040693-V	11-19-21	EKSANTRİK MİLİ Cam Shaft	7700619641	7700719273	12014403	508.489	30,00	40,00		7,00		L3T SAĞ -Right	FKM
041198-V	MASTER-CLIO-KANGOO-LAGUNA- MEGANE-TRAFİC-R19	EKSANTRİK MİLİ Cam Shaft	7700101348	6001543856	20019850	365.940	30,00	42,00		6,00		L3TL SAĞ -Right	FKM
040789-V	EXPRESS-MEGANE	EKSANTRİK MİLİ Cam Shaft	7700749395	7700743160	12011839	-	30,00	42,00		7,00		L3T SAĞ -Right	FKM
040880-P	MASTER-TRAFIC 2.5 DCI-G9U	EKSANTRİK MİLİ Cam Shaft	5000820862	9031130017	12010674	277.142 440.720	30,00	42,00		7,00		L3TL SAĞ -Right	ACM
040719	R5	EKSANTRİK MİLİ Cam Shaft	7703087104	-	46081151	302.430	30,00	42,00		8,00		L3L	NBR
041267-FP	CLIO III-SCENIC-MEGANE II/III-MO- DUS-LAGUNA 1.6 MOT. K4M-716-760	EKS.MİLİ-VANOS Cam Shaft - Vanos System	8200168254	7701474363	19036652	505.600 81-38507-00	33,00	42,00		6,00		F2TL SAĞ -Right	PTFE+ACM
040634-S	9-11-12-19-21	EKSANTRİK MİLİ Cam Shaft	7703087097	3277600	12011246	507.806	35,00	50,00		10,00		L3L SAĞ -Right	VMQ
041250-V	LAGUNA-CLIO-SAFRANE	EKSANTRİK MİLİ Cam Shaft	9609874280	-	20018317	135.140 81-34146-00	38,00	50,00		6,00		L3TL SAĞ -Right	FKM
046256-V	LAGUNA-SAFRANE 2.0-2.5 BENZ.MOT.	EKSANTRİK MİLİ Cam Shaft	7436842272	-	15018287	135.180	45,00	57,00		7,00		L3L SAĞ -Right	FKM
045990-V	MASTER-TRAFIC 2.4-2.5 D-TD-DTI	EKSANTRİK MİLİ Cam Shaft	7701035740	7701045541	12015120	419.730	55,00	70,00		8,00		L13TL SAĞ -Right	FKM
040922-V	LAGUNA-SAFRANE 2.0-2.5 MOT.	YARDIMCI MİL Auxiliary Shaft	7433514943	7439443310	15000581	733.620 135.151	30,00	47,00		7,00		L3	FKM
047870-VP	MASTER-TRAFIC-LAGUNA 2.5 DCI-G9U	YARDIMCI MİL Auxiliary Shaft	7700103946	-	46085512	542.060	70,00	85,00		7,00		L3TL SAĞ -Right	FKM+ACM
45-059-V	CLIO-MEGANE-LAGUNA-KANGOO-TRAF- IC-1.4-1.6-1.8-2.0 16V K4M-K4J	SUPAP Valve Stem Seal	7700103938	-	46023004	151.810	5,50	11,00	28,00	16,40		LSY5T	FKM
45-025-V	CLIO-KANGOO-MEGANE-MASTER-TRAF- IC-SCENIC 1.5 DCI =>2004,2.5 DCI	SUPAP Valve Stem Seal	7700109840	-	12014670	724.590 70-33512-00	6,00	8,80	12,20	6,00	10,00	LSY2T	FKM
45-045-V	MASTER-TRAFIC 2.5 DCI-G9U	SUPAP Valve Stem Seal	8631652	-	12016586 49472882	069.630 70-33512-00	6,00	8,80	11,70	9,50		LSY2T	FKM
45-033-V	CLIO-MASTER-TRAFİC-KANGOO-ME- GANE 1.9 DCI-DTI-1.4-1.6	SUPAP Valve Stem Seal	7700736465	7700103872	12015802 49472012	701.289 70-26058-00	7,00	9,80	13,20	5,00	10,00	LSY2T	FKM
45-021-V	MEGANE-KANGOO-EXPRESS-CLIO 1.7-2.0-1.9 D-TDI	SUPAP Valve Stem Seal	7700737124	7700733464	12014584 49472013	294.110	8,00	10,80	14,20	5,50	10,00	LSY2T	FKM

MOTOR GRUBU / Engine Group

SKT NO	KULLANILAN MODELLER Models	KULLANIM YERİ Place Of Use	ORJINAL NO 1 Original No 1	ORJINAL NO 2 Original No 2	EŞDEĞER NO 1 Equivalent No 1	EŞDEĞER NO 2 Equivalent No 2	ÖLÇÜLER MM. Dimensions - MM.					TİP Type	MALZEME Material
45-030-V	MASTER-TRAFIC 2.8 HDI	SUPAP Valve Stem Seal	5001001582	7701040023	12015512	143.930 104.380	8,00	12,00	15,20	5,70	9,50	LSY2T	FKM
45-051-V	MASTER-TRAFIC 2.8 HDI	SUPAP Valve Stem Seal	5001001582	7701040023	12015512	143.930 104.380	8,00	12,00	15,00	6,00	9,50	LSY2T	FKM
45-071-V	CLIO II 1.2, 1.2 16V MOT. D4F- 732-740	SUPAP Valve Stem Seal	8200171215	-	12019883 49472016	12019982 522.930	5,50	8,30	11,50	8,00		LSY2T	FKM
040941-V	9 B.W DIZ.L424	YAKIT POMPASI Fuel Pump	5001833930	42530475	12019583	-	17,00	28,00		7,30		L13TL	FKM
4TP-019-P	MEGANE-SCENIC-KANGO CLIO 1.6 16V	EKS. MİLİ ARKA TAPASI-(Küçük) Cam Shaft-Rear	7700274026	-	-	-		42,50		9,00		T3T	ACM
4TP-018-P	MEGANE-SCENIC-KANGO CLIO 1.6 16V	EKS. MİLİ ARKA TAPASI-(Büyük) Cam Shaft-Rear	7700106271	-	-	-		57,00		10,50		T3T	ACM

MOTOR CONTA GRUBU/Engine Gasket Group

SKT NO	KULLANILAN MODELLER Models	KULLANIM YERİ Place Of Use	ORJINAL NO 1 Original No 1	ORJINAL NO 2 Original No 2	EŞDEĞER NO 1 Equivalent No 1	EŞDEĞER NO 2 Equivalent No 2	ÖLÇÜLER MM. Dimensions - MM.					TİP Type	MALZEME Material
4C-001-70	CLIO, MEGANE, KANGOO 1.5 DCI (2004 VE ÖNCESİ - K9K 700-702)	SİLİNDİR KAPAK CONTASI Cylinder Head Gasket	82 00 071 111	-	61-36345-00	414238P/ 262.871				0,6 mm			
4C-002-70	CLIO, KANGOO, MEGANE 1.5DCI (2005 VE SONRASI İÇİN)	SİLİNDİR KAPAK CONTASI Cylinder Head Gasket	8200360571	-	61-36975-00	414240P/ 338.861				0,7 mm			
4C-003-70	CLIO IV/FLUENCE/MEGANE III 1.5 DCI (EURO 5 - K9K)	SİLİNDİR KAPAK CONTASI Cylinder Head Gasket	8200862244	-	61-37930-10	415632P/ 688.412				0,8 mm			
4C-004-70	MASTER 2.5 DCI (G9U)	SİLİNDİR KAPAK CONTASI Cylinder Head Gasket	82 00 406 743	-	61-36540-00	415288P/ 517.411				1,20 mm			
4C-001-51	CLIO, MEGANE, KANGOO 1.5 DCI (K9K 700-702)	ALT TAKIM CONTA Gasket Set Crank Case	-	-	-	-				FKM (VİTON) Keçeli			
4C-002-51	CLIO, MEGANE, KANGOO 1.5 DCI (040520=> K9K 714-800)	ALT TAKIM CONTA Gasket Set Crank Case	-	-	-	-				FKM (VİTON) Keçeli			
4C-001-50	CLIO, MEGANE, KANGOO 1.5 DCI (K9K 700-702)	ALT TAKIM CONTA Gasket Set Crank Case	-	-	-	-				PTFE (TEFLON) Keçeli			
4C-002-50	CLIO, MEGANE, KANGOO, LOGAN 1.5 DCI (040520=>/K9K 714-800)	ALT TAKIM CONTA Gasket Set Crank Case	-	-	-	-				PTFE (TEFLON) Keçeli			
4C-001-30	CLIO, MEGANE, KANGOO 1.5 DCI (2004 VE ÖNCESİ)	ÜST TAKIM CONTA Cylinder Head Gasket Set	7701473371	-	02-36345-01	-				Silindir kapak contalı			

MOTOR CONTA GRUBU/Engine Gasket Group

SKT NO	KULLANILAN MODELLER Models	KULLANIM YERİ Place Of Use	ORJINAL NO 1 Original No 1	ORJINAL NO 1 Original No 2	EŞDEĞER NO 1 Equivalent No 1	EŞDEĞER NO 1 Equivalent No 2	ÖLÇÜLER MM. Dimensions - MM.				TİP Type	MALZEME Material
4C-002-30	CLIO,KANGOO,MEGANE1.5DCI 2005=> K9K 732/734/764/780/804/806/832	ÜST TAKIM CONTA Cylinder Head Gasket Set	7701477501	-	02-36975-02	-	Silindir kapak contalı					
4C-002-31	CLIO,KANGOO,MEGANE 1.5DCI 2005=> K9K800/802/812/830/G724/700/702	ÜST TAKIM CONTA Cylinder Head Gasket Set	7701476729	-	02-36975-01	-	Silindir kapak contalı					
4C-003-30	CLIO IV/FLUENCE/MEGANE III 1.5 DCI (EURO 5 - K9K)	ÜST TAKIM CONTA Cylinder Head Gasket Set	-	-	-	-	Silindir kapak contalı					
4C-004-30	MASTER 2.5 DCI (G9U)	ÜST TAKIM CONTA Cylinder Head Gasket Set	7701477813	-	-	-	Silindir kapak contasız					
4C-004-10	MASTER 2.5 DCI (G9U)	TAM TAKIM CONTA Full Set Gasket	-	-	-	-	Silindir kapak contasız					

AKS GRUBU / Axle Group

SKT NO	KULLANILAN MODELLER Models	KULLANIM YERİ Place Of Use	ORJINAL NO 1 Original No 1	ORJINAL NO 1 Original No 2	EŞDEĞER NO 1 Equivalent No 1	EŞDEĞER NO 1 Equivalent No 2	ÖLÇÜLER MM. Dimensions - MM.				TİP Type	MALZEME Material	
4D-126	12 TOROS	ARKA AKS Rear Axle	7700622842	-	-	-	34,60	57,50		6,00		SB6	NBR
045536	12 TOROS	ARKA AKS Rear Axle	855599900	7703087057	-	-	48,00	58,00		4,00		L2	NBR
045618	12 TOROS	ARKA AKS Rear Axle	7703087072	-	07011551	-	48,70	58,00		9,10		L5R	NBR
045618-P	12 TOROS	ARKA AKS Rear Axle	7703087072	-	07011551	-	48,70	58,00		9,10		L5R	ACM
047695	MASTER I-II	ARKA AKS Rear Axle	5000389751	5000389994	12013927	046.904	65,00	85,00		10,00		L3TL	NBR
4KIT-041	12 TOROS	ARKA AKS TM.TK. Rear Axle Rapair Kit	7703087072	-	-	-						KIT	-

FREN GRUBU / Brake Group

SKT NO	KULLANILAN MODELLER Models	KULLANIM YERİ Place Of Use	ORJINAL NO 1 Original No 1	ORJINAL NO 2 Original No 2	EŞDEĞER NO 1 Equivalent No 1	EŞDEĞER NO 2 Equivalent No 2	ÖLÇÜLER MM. Dimensions - MM.				TİP Type	MALZEME Material	
4D-284-T	9 B.W DIZ.L424	FREN HİD.MRKZ.CONTASI Brake Hyd.Cylinder Gasket	7701019337	-	-	-	11,30	27,00		13,00		MH	NR
4D-305-E	9-11-21	FREN HİD.MRKZ.SİLİNDİRİ Brake Hyd.Cylinder	L379084	-	-	-	11,30	27,00		13,00		MH	EPDM
4U-311-E	9-11-21	ARKA AKS FREN LASTİĞİ Rear Axle-Brake Gasket	L374235	11007104	-	-	13,55	22,00		6,65		SPUCL	EPDM
045514	9-11 SERİSİ (FREN-WESTINGHOUSE)	FREN DIYAFRAM SLD. Brake Diaphragm	ZZL1121	7H6519	-	-	38,10	51,00		5,55		L3	NBR
4TM-054	12 TOROS	ÖN AKS SİLİNDİRİ TM.TK. Front Axle Cyl. Repair Kit	-	-	-	-						TM	-
4TM-055	9-11-21	FREN HİD.MRKZ.SİLİNDİRİ Brake Hyd.Cylinder	-	-	-	-						TM	-

DİFERANSİYEL GRUBU / Differential Group

SKT NO	KULLANILAN MODELLER Models	KULLANIM YERİ Place Of Use	ORJINAL NO 1 Original No 1	ORJINAL NO 2 Original No 2	EŞDEĞER NO 1 Equivalent No 1	EŞDEĞER NO 2 Equivalent No 2	ÖLÇÜLER MM. Dimensions - MM.				TİP Type	MALZEME Material	
046259-P	MEGANE-SYMBOL-CLIO-KANGOO-LOGAN 1.2-1.4-1.6 BENZ.MOT.	DİFERANSİYEL SAĞ ÇIKIŞ Dif.-Right Output	8200068744 8700276850	7701029126	01029132	050.560	27,95	56,00		7,00		L3TL SAĞ -Right	ACM
046234-V	CLIO-G.SCENIC-KANGOO-MEGANE-MO- DUS-SCENIC	DİFERANSİYEL SAĞ ÇIKIŞ Dif.-Right/Left Output	7703087210	-	20026878	NA5490	27,94	56,00		8,00		L3TL SAĞ -Right	FKM
045750-P	R9-11-19-CLIO-EKSPRES-KANGOO-ME- GANE-1.5 DCİ	DİFERANSİYEL SAĞ ÇIKIŞ Dif.-Right Output	7703087146	7701349715	07011906	050.560	27,95	56,00		10,00		L3TL SAĞ -Right	ACM
045789-P	CLIO-EKSPRES-KANGOO-MEGANE 5-9-1911-19-21 1.5 DCİ	DİFERANSİYEL SAĞ ÇIKIŞ Dif.-Right Output	7703087148	-	12015423	722.580	27,95	70,00		10,00		L3TL SAĞ -Right	ACM
046157-V	MASTER-TRAFIC 1.9 - 2.5 DCİ	DİFERANSİYEL SAĞ ÇIKIŞ Dif.-Right Output	7701474122	-	12017115	-	30,00	52,00		7,00	11,00	L3TL SAĞ -Right	FKM
046118-FP	CLIO-LAGUNA-MEGANE-MODUS- KANGOO-SEMBOL-SCENIC 1.5 DCİ	DİFERANSİYEL SAĞ ÇIKIŞ Differential Right Output	8200183825	8200621239	20033804	1954012	33,00	55,00		8,50	13,50	L3TFR SAĞ-Right	PTFE+ACM
045524-NK	12 TOROS	DİFERANSİYEL SAĞ ÇIKIŞ Dif.-Right/Left Output	7703097011	-	-	-	36,00	54,00		11,00		SL3K	NBR+YÜN
046117-P	CLIO-LAGUNA-MEGANE-MODUS- KANGOO-SEMBOL-SCENIC 1.5 DCİ	DİFERANSİYEL SOL ÇIKIŞ Differential Left Output	8200110847	8200717349	01033808	964.880	40,00	55,00		8,00	13,00	L3TLR SS-RL	ACM
046238-PF	CLIO-G.SCENIC-KANGOO-MEGANE-MO- DUS-SCENIC	DİFERANSİYEL SOL ÇIKIŞ Differential Left Output	8200279711	7703087209	20034245	-	40,00	54,00		6,80		SPL3TL SOL-Left	ACM+PTFE
046252-V	CLIO-MEGANE-SCENIC-SEMBOL-FLUENCE EDC TİP OTM.ŞANZİMAN MOD.-	DİF.SAĞ-SOL ÇIKIŞ OTM.ŞANZ. Dif.-Right/Left Output-Auto.	383427234R	-	9009059560	-	40,00	55,00		8,50		L13TLL SS-RL	FKM

ŞANZIMAN GRUBU / Gearbox Group

SKT NO	KULLANILAN MODELLER Models	KULLANIM YERİ Place Of Use	ORJINAL NO 1 Original No 1	ORJINAL NO 2 Original No 2	EŞDEĞER NO 1 Equivalent No 1	EŞDEĞER NO 2 Equivalent No 2	ÖLÇÜLER MM. Dimensions - MM.				TİP Type	MALZEME Material	
040421	12 TOROS	ŞANZIMAN ÖN Gearbox Front	7703087085	7700522671	12011426	-	17,00	28,00		7,00	13,00	L3C SAĞ -Right	NBR
041285-P	CLIO-FLUANCE-KANGOO-LAGUNA-MEGANE-TRAFIC-MODUS	ŞANZIMAN ÖN Gearbox Front	7700852548	8200544206	19036867	-	24,50	42,00		6,00		L3TL SAĞ -Right	ACM
045743	MESSENGER-B	ŞANZIMAN ÖN Gearbox Front	0634300541	5000241551	01002604	-	48,00	62,00		10,00		L1L	NBR
046225-V	CLIO 1-2-MODUS-KANGO-MEGANE 2-SCENIC	ŞANZIMAN ÖN-OTOM. ŞANZ. Gearbox Front-Auto. Gear	7703087217	8200834449	20035271	20026876	54,50	72,00		6,50		L3TL SAĞ -Right	FKM
4H-887-50	9-11-19-21	ŞANZIMAN ARKA KAPAK O-RİNGİ Gearbox Rear Cover-O-ring	7704002415	-	-	-	154,00			6,25		O	NBR
040485	9-11-12-19-21	ŞANZ. KLM ÇIKIŞ MİLİ Speedometer Shaft	7703087074	-	-	-	8,40	16,00		6,50		L3	NBR
040410	12 TOROS	VİTES SEÇİCİ MİLİ Gear Selection Shaft	6000046077	-	12010791	-	15,00	26,00		7,00		L3	NBR
040641	12 TOROS	VİTES SEÇİCİ MİLİ Gear Selection Shaft	7703087069	-	-	-	15,00	26,00		9,00		L1L	NBR
041117-P	CLIO-KANGOO-MEGANE-LAGUNA-TWINGO 1.5 DCİ	VİTES SEÇİCİ MİLİ Gear Selection Shaft	7703087163	-	12018001	-	16,00	26,00	36,00	10,00	12,00	SPL3TL	ACM
040643-P	9-11-12-19-21-CLIO-KANGO-MEGANE-TWINGO	VİTES SEÇİCİ MİLİ Gear Selection Shaft	7703087163	M343801	12018001	-	16,00	26,00	36,00	10,40	12,00	SPL3L	ACM

DİREKSİYON GRUBU / Steering Group

SKT NO	KULLANILAN MODELLER Models	KULLANIM YERİ Place Of Use	ORJINAL NO 1 Original No 1	ORJINAL NO 2 Original No 2	EŞDEĞER NO 1 Equivalent No 1	EŞDEĞER NO 2 Equivalent No 2	ÖLÇÜLER MM. Dimensions - MM.				TİP Type	MALZEME Material	
040642	9-11-21	DİREKSİYON SİSTEMİ Steering System	7703087145	-	-	-	18,10	32,00		4,30	6,30	L3L	NBR
041132-V	MASTER	DİREKSİYON POMPA Steering Pump	077008434	-	15020025	-	19,00	32,00		7,00		L3BTL	FKM
041134	CLIO	DİREKSİYON KUTUSU Steering Box	-	-	12012530	-	19,00	34,60		6,20	9,20	L3BL	NBR
041201	MEGANE	DİREKSİYON MİLİ Steering Shaft	-	-	12015526	-	19,05	34,60		4,40	5,90	L3BTL	NBR
041128	CLIO-MEGANE	DİREKSİYON KUTUSU Steering Box	-	-	12012050	-	23,00	34,30		6,35		L3B	NBR

DİREKSİYON GRUBU / Steering Group

SKT NO	KULLANILAN MODELLER Models	KULLANIM YERİ Place Of Use	ORJINAL NO 1 Original No 1	ORJINAL NO 2 Original No 2	EŞDEĞER NO 1 Equivalent No 1	EŞDEĞER NO 2 Equivalent No 2	ÖLÇÜLER MM. Dimensions - MM.					TİP Type	MALZEME Material
040930-NL	CLIO-MEGANE	DİREKSİYON SİSTEMİ Steering System	12340591	-	19020602	-	24,00	36,50		7,50		SPL3B	NBR+TPU
040850	OTOMOBİL SERİSİ	DİREKSİYON MİLİ Steering Shaft	7701027247	0069977647	01001681	-	30,00	42,00		6,00		L3BTL	NBR
041202-H	MEGANE 2	DİREKSİYON KUTUSU Steering Box	-	-	19020602	-	24,00	36,50		8,50		L3B	HNBR
040905	19-21	DİREKSİYON SİSTEMİ Steering System	-	-	12017116	-	25,00	33,00	37,00	6,50	7,50	SPL1B	NBR
041129-H	MASTER-LAGUNA	DİREKSİYON KUTUSU Steering Box	-	-	19019827	-	27,70	38,00		8,50		L3B	HNBR
041118-H	R19 (ZF TİP KUTU)	DİREKSİYON KUTUSU Steering Box	0770080425	0770198107	01016891	-	28,00	37,00		5,00		L3BT	HNBR
041131-H	OTOMOBİL SERİSİ	DİREKSİYON KUTUSU Steering Box	-	-	19029685	-	19,05	33,30		7,90		L12BL- SAĞ-Right	HNBR
040902	19-21-MEGANE-LAGUNA	HİDROLİK DİREKSİYON KUTUSU Power Steering Box	-	-	-	-	19,00	30,00		6,00		SPL3BL	NBR
041251-NL	CLIO-MEGANE	HİDROLİK DİREKSİYON KUTUSU Power Steering Box	34003726	-	12012051	-	23,00	34,43	38,00	3,70	7,50	SPL3B	NBR+TPU
040906	R 19-21-ESPACE	HİDROLİK DİREKSİYON KUTUSU Power Steering Box	-	-	12016925	-	25,00	37,00		7,20		SPL3B	NBR
040907	R 19-21-ESPACE	HİDROLİK DİREKSİYON KUTUSU Power Steering Box	-	-	12016926	-	25,00	38,20		7,20		SPL3B	NBR
040903	R 21 - MENAGER-MASTER- MEGANE-LAGUNA	HİDROLİK DİREKSİYON KUTUSU Power Steering Box	-	-	19019968	-	28,50	43,00		6,50		SPL3B	NBR

MOTOR GRUBU / Engine Group

SKT NO	KULLANILAN MODELLER Models	KULLANIM YERİ Place Of Use	ORJINAL NO 1 Original No 1	ORJINAL NO 2 Original No 2	EŞDEĞER NO 1 Equivalent No 1	EŞDEĞER NO 2 Equivalent No 2	ÖLÇÜLER MM. Dimensions - MM.				TİP Type	MALZEME Material	
041272-FP	CORDOBA-IBIZA-INCA-TOLEDO-LEON-ALTEA	KRANK ÖN Crank Shaft Front	038103085C	038103085A	20026413	129.780	32,00	47,00		10,00		F2TL SAĞ -Right	PTFE+ACM
040969-V	CORDOBA-IBIZA-MALAGA	KRANK ÖN Crank Shaft Front	0544115147A	069115147	12010739	294.357 475.961	35,00	48,00		10,00		L3TL SAĞ -Right	FKM
041273-FP	ALTEA-IBIZA-TOLEDO-LEON-CORDOBA 1.6TDI-2.0TDI-1.4TSI	KRANK ÖN Crank Shaft Front	038103085	038103085B	20026412	155.560	35,00	48,00		10,00		F2TL SAĞ -Right	PTFE+ACM
045898-V	IBIZA-CORDOBA-TOLEDO-INCA	KRANK ÖN Crank Shaft Front	12012068	-	700004122A	-	40,00	56,00		7,00		L13TL SAĞ -Right	FKM
047640-V	EXPERT	KRANK ARKA Crank Shaft Rear	051.477	40004280	40000460	440.780	64,00	80,00		8,00		L13TL SOL -Left	FKM
047601-V	IBIZA-ALTEA-CORDOBA-LEON-TOLEDO	KRANK ARKA Crank Shaft Rear	40004120	4358946	700004123A	440.830	74,00	90,00		10,00		L13TL SOL -Left	FKM
410276-V	IBIZA-ALTEA-CORDOBA-LEON-TOLEDO	KRANK ARKA Crank Shaft Rear	047103085A	959085112	12015256	508-462 81-23708-50	85,00	105,00		12,00		L3TL SOL -Left	FKM
415242-FAEK	ALTEA-CORDOBO-LEON-TOLEDO 1.6-1.6l-1.8-2.0 FSI-TFSI BENZİN MT.	KRANK ARKA Crank Shaft Rear	06B103171B	06B103171D	20019557	012.380	85,00	131,00	152,00	15,70		SP F AL8	PTFE+ AEM+YÜN
041310-FP	TOLEDO-LEON-IBIZA 1.0-1.2-1.4 TFSI	EKSANTRİK MİLİ-ARKA Cam Shaft-Rear	04E 103 085	04E103085AC	20037127	242.620	24,00	39,00		8,00		F2TL SOL -Left	PTFE+ACM
045583-P	IBIZA-CORDOBA-TOLEDO-INCA	EKSANTRİK MİLİ Cam Shaft	12011539	-	40000470	212.458	30,00	52,00		7,00		L1 SAĞ -Right	ACM
041309-V	CORDOBA-IBIZA-TOLEDO 1.4-1.6 MOT.	EKSANTRİK MİLİ Cam Shaft	036 103 085 H	036103085C	19036807	158.060	32,00	42,00		6,00	7,00	L13TL SAĞ -Right	FKM
040946-V	CORDOBA-IBIZA-LEON-TOLEDO-ALTEA	EKSANTRİK MİLİ Cam Shaft	068103085E	026103085F	12012709	325.155 325.156	32,00	47,00		10,00		L3TL SAĞ -Right	FKM
041308-FP	LEON-IBIZA-ATECA-ARONA 1.0-1.2-1.4-1.5 TFSI-TSI	EKSANTRİK MİLİ Cam Shaft	04E103085B	04E103085AF	242.650	-	36,00	46,00		7,00		F2TL SAĞ -Right	PTFE+ACM
45-025-V	ALTEA-INCA-CORDOBA 2.0 TDI-TFSI	SUPAP Valve Stem Seal	036109675	036109675A	724.590	724.590 70-33512-00	6,00	8,80	12,20	9,70		LSY2T	FKM
45-033-V	ALTEA-CORDABA-IBIZA-LEON-TOLEDO	SUPAP Valve Stem Seal	020012326A	-	12014671	701.289 70-26058-00	7,00	9,80	13,20	9,70		LSY2T	FKM
45-021-V	CORDOBA-IBIZA-LEON-TOLEDO	SUPAP Valve Stem Seal	5959598	-	12014584 49472013	294.110	8,00	10,80	14,20	10,00		LSY2T	FKM

AKS GRUBU / Axle Group

SKT NO	KULLANILAN MODELLER Models	KULLANIM YERİ Place Of Use	ORJINAL NO 1 Original No 1	ORJINAL NO 2 Original No 2	EŞDEĞER NO 1 Equivalent No 1	EŞDEĞER NO 2 Equivalent No 2	ÖLÇÜLER MM. Dimensions - MM.					TİP Type	MALZEME Material
046006	CORDOBA-IBIZA-LEON-TOLEDO- ALTEA-INCA	ARKA AKS Rear Axle	357501641B	-	12011153	045.772	40,00	52,00	58,00	7,50		SPL3TL	NBR
045560	IBIZA-CORDOBA-TOLEDO-INCA-ALTEA	ARKA AKS Rear Axle	02D409399	-	12017270	063.665	45,00	60,00		8,00		L3L	NBR

DİFERANSİYEL GRUBU / Differential Group

SKT NO	KULLANILAN MODELLER Models	KULLANIM YERİ Place Of Use	ORJINAL NO 1 Original No 1	ORJINAL NO 2 Original No 2	EŞDEĞER NO 1 Equivalent No 1	EŞDEĞER NO 2 Equivalent No 2	ÖLÇÜLER MM. Dimensions - MM.					TİP Type	MALZEME Material
041139-P	RONDA	DİFERANSİYEL SAĞ ÇIKIŞ Dif.-Right Output	40003040	71734489	12014825	-	29,80	50,00		10,00	13,50	L13TLR SAĞ-Right	ACM
046275-PL	IBIZA-CORDOBA-ALTEA 1.9 TDI	DİFERANSİYEL SAĞ ÇIKIŞ Dif.-Right Output	02J409528A	02J409528C	01033861	228.490	48,00	60,00	74,00	12,60	26,60	SPL3L SAĞ-Right	ACM+NYL
045821-P	ALTEA-LEON-IBIZA-TOLEDO	DİFERANSİYEL SAĞ ÇIKIŞ Dif.-Right/Left Output	02T409189C	02T409189C	01031878 12000767	454.260	50,00	65,00		8,00		L3L	ACM
045698-V	ALTEA-CORDOBA-IBIZA-LEON-INCA	DİFERANSİYEL SOL ÇIKIŞ Differential Left Output	02J409189A	-	07033882 12015555	-	48,00	62,00		8,00		L3L	FKM
046233-P	CORDOBA-IBIZA-LEON-TOLEDO	DİFERANSİYEL SAĞ-SOL ÇIKIŞ Dif.-Right/Left Output	02J409189A	02J409189B	12015555	228.480	48,00	62,00		8,00		L3TL SS- RL	ACM
046229-P	ALTEA-IBIZA-LEON-TOLEDO - 1.4 TSI-1.6-1.6FSI-1.9-2.0 TDI	DİFERANSİYEL SAĞ-SOL ÇIKIŞ Dif.-Right/Left Output	02T409189	02T409189C	01031878	454.260	50,00	65,00		8,00		L13L SS- RL	ACM
045867-P	CORDOBA-ALTEA-IBIZA-LEON-INCA	DİFERANSİYEL SAĞ-SOL ÇIKIŞ Dif.-Right/Left Output	02M409189	-	01033858	-	50,00	65,00		10,00		L3TLL SS-RL	ACM
046276-P	CORDOBA	DİFERANSİYEL SAĞ-SOL ÇIKIŞ Dif.-Right/Left Output	020301189T	020301189H	12016928	527.858	50,00	65,20		10,00		L3TL SS- RL	ACM
046230-P	ALTEA-IBIZA-LEON-TOLEDO- 1.4TDI-1.4-TSI-1.6-1.9-2.0 TDI	DİFERANSİYEL SAĞ-SOL ÇIKIŞ Dif.-Right/Left Output	02M301189B	-	01029144	454.820	60,00	74,00		8,00		L13L SS- RL	ACM

ŞANZİMAN GRUBU / Gearbox Group

SKT NO	KULLANILAN MODELLER Models	KULLANIM YERİ Place Of Use	ORJINAL NO 1 Original No 1	ORJINAL NO 1 Original No 2	EŞDEĞER NO 1 Equivalent No 1	EŞDEĞER NO 1 Equivalent No 2	ÖLÇÜLER MM. Dimensions - MM.				TİP Type	MALZEME Material	
041311-P	TOLEDO-LEON-IBIZA 1.4 TSI-1.6 TDI-1.8 TSI	ŞANZİMAN ÖN-AUTO. Gearbox Front-Automatic	0AM 301 733 K	0AM 301 733 H	01035820	908.420	20,50	28,00		7,00		L13L SS-RL	ACM
041062-P	CORDOBA-IBIZA-LEON-TOLEDO-ALTEA	ŞANZİMAN ÖN Gearbox Front	085311113	-	12015554	191.320	21,80	35,00		7,00		L3TL SAĞ -Right	ACM
041270-P	CORDOBA-IBIZA-INCA-TOLEDO	ŞANZİMAN ÖN Gearbox Front	20311113	-	12017266	244.040	21,90	40,00		8,00		L3TL SAĞ -Right	ACM
040943-P	AROSA 1.0 CC	ŞANZİMAN ÖN Gearbox Front	002301227A	959022407	01025576	-	22,00	32,00		7,00		L13TL SAĞ -Right	ACM
041315-P	IBIZA-LEON-TOLEDO	ŞANZİMAN ÖN Gearbox Front	020311113B	-	12016924	-	23,90	40,00		8,00		L3TL SAĞ -Right	ACM
041275-P	ALTEA-IBIZA-TOLEDO-LEON-CORDOBA	ŞANZİMAN ÖN Gearbox Front	02T311113A	-	01026708	870.310	24,00	38,00		6,00		L3T SAĞ -Right	ACM
040738-P	ALTEA-IBIZA-LEON-TOLEDO	ŞANZİMAN ÖN Gearbox Front	2M311113	2M311113A	12016518	549.969	28,00	42,00		7,00		L3TL SAĞ -Right	ACM
040738-V	ALTEA-IBIZA-LEON-TOLEDO	ŞANZİMAN ÖN Gearbox Front	2M311113	2M311113A	16012080	549.969	28,00	42,00		7,00		L3TL SAĞ -Right	FKM
040748-V	CORDOBA-IBIZA-LEON-TOLEDO	VİTES SEÇİCİ MİLİ Gear Selection Shaft	020311108A	020311109G	01020437	322.415	8,00	14,00		4,00		L13	FKM
040838	CORDOBA - ALTEA-TOLEDO	VİTES SEÇİCİ MİLİ Gear Selection Shaft	020301227F	020301227D	01019317	-	18,00	30,00		6,40	8,00	L3BTL	NBR

DİREKSİYON GRUBU / Steering Group

SKT NO	KULLANILAN MODELLER Models	KULLANIM YERİ Place Of Use	ORJINAL NO 1 Original No 1	ORJINAL NO 1 Original No 2	EŞDEĞER NO 1 Equivalent No 1	EŞDEĞER NO 1 Equivalent No 2	ÖLÇÜLER MM. Dimensions - MM.				TİP Type	MALZEME Material	
041123-H	LEON	DİREKSİYON KUTUSU Steering Box	0770080436	0770198203	01016892	-	24,00	33,00		5,00		L3BTI	HNBR
041204-H	LEON	DİREKSİYON KUTUSU Steering Box	7891033104	-	01019952	-	24,00	37,00		8,50		L3B	HNBR
041212-NL	OTOMOBİL SERİSİ	DİREKSİYON KUTUSU Steering Box	7891033104	-	01019952	-	24,00	37,00		8,50		L3BTI	NBR+TPU
041203-H	LEON	DİREKSİYON KUTUSU Steering Box	7891033105	-	01016893	-	24,00	39,00		8,50		L3B	HNBR
040849	EM	DİREKSİYON SİSTEMİ Steering System	113415297	-	19015771	164.500	28,00	40,00		6,00		L3BTL	NBR
040786	LEON	HİD.DİR. KUTU SAĞ-SOL Power Steering Box	0770804457	-	01016891	-	28,00	37,00		5,00		L3BTL	NBR

MOTOR GRUBU / Engine Group

SKT NO	KULLANILAN MODELLER Models	KULLANIM YERİ Place Of Use	ORJINAL NO 1 Original No 1	ORJINAL NO 2 Original No 2	EŞDEĞER NO 1 Equivalent No 1	EŞDEĞER NO 2 Equivalent No 2	ÖLÇÜLER MM. Dimensions - MM.				TİP Type	MALZEME Material	
041272-FP	FABIA-OCTAVIA-RAPID-SUPERB-ROOM-STAR-YETİ	KRANK ÖN Crank Shaft Front	038103085C	038103085A	20026413	129.780	32,00	47,00		10,00		F2TL SAĞ -Right	PTFE+ACM
040969-V	FABIA-OCTAVIA	KRANK ÖN Crank Shaft Front	054115147	-	12010739	294.357 475.961	35,00	48,00		10,00		L3TL SAĞ -Right	FKM
041273-FP	FABIA-OCTAVIA-RAPID-SUPERB-ROOM-STAR-YETİ	KRANK ÖN Crank Shaft Front	038103085	038103085B	20026412	155.560	35,00	48,00		10,00		F2TL SAĞ -Right	PTFE+ACM
046008-V	FABIA-FAVORIT-FELICIA-OCTAVIA	KRANK ÖN Crank Shaft Front	047103085	-	20034575	290.760	42,00	58,00		8,00		L3TL SAĞ -Right	FKM
410276-V	FELICIA-OCTAVIA-ROOMSTAR-FAVORIT	KRANK ARKA Crank Shaft Rear	68198171	047103085A	12015257 12018066	508-462 81-23708-50	85,00	105,00		12,00		L3TL SOL -Left	FKM
415242-FAEK	OCTAVIA - 1.6-1.6İ-1.8-2.0 BENZİN MOT.	KRANK ARKA Crank Shaft Rear	06B103171B	06B103171D	20019557	012.380	85,00	131,00	152,00	15,70		SP F AL8	PTFE+ AEM+YÜN
041310-FP	CAMIQ-FABIA-CITIGO-OCTAVIA-RAP- ID-SCALA-YETİ 1.0-1.2-1.4 TFSI	EKSANTRİK MİLİ-ARKA Cam Shaft-Rear	04E 103 085	04E103085AC	20037127	242.620	24,00	39,00		8,00		F2TL SOL -Left	PTFE+ACM
041309-V	OCTAVIA 1.4-1.6 MOT.	EKSANTRİK MİLİ Cam Shaft	036 103 085 H	036103085C	19036807	158.060	32,00	42,00		6,00	7,00	L13TL SAĞ -Right	FKM
040946-V	FELICIA-OCTAVIA-ROOMSTAR-SUPERB	EKSANTRİK MİLİ Cam Shaft	068103085E	026103085F	12010668	325.155 325.156	32,00	47,00		10,00		L3TL SS- RL	FKM
041308-FP	FABIA-CITIGO-OCTAVIA-KODIAQ-KAROQ 1.0-1.2-1.4-1.5 TFSI-TSI	EKSANTRİK MİLİ Cam Shaft	04E 103 085 B	04E 103 085 AF	242.650	-	36,00	46,00		7,00		F2TL SAĞ -Right	PTFE+ACM
4S-025-V	FABIA-OCTAVIA-ROOMSTAR-SUBERP	SUPAP Valve Stem Seal	036109675A	036109675	12014670	724.590 70-33512-00	6,00	8,80	12,20	9,70		LSY2T	FKM
4S-033-V	FABIA-OCTAVIA-ROOMSTAR-SUB- ERP-FELICIA	SUPAP Valve Stem Seal	027109675	-	12014671	701.289 70-26058-00	7,00	9,80	13,20	9,70		LSY2T	FKM
4S-021-V	FAVORIT-FELICIA	SUPAP Valve Stem Seal	114028540	-	12014584 49472013	294.110	8,00	10,80	14,20	10,00		LSY2T	FKM
045645	EM-RAPID	SU POMPASI Water Pump	953042307	-	12010943	344.300	42,00	56,00		7,00		L3	NBR

AKS GRUBU / Axle Group

SKT NO	KULLANILAN MODELLER Models	KULLANIM YERİ Place Of Use	ORJINAL NO 1 Original No 1	ORJINAL NO 2 Original No 2	EŞDEĞER NO 1 Equivalent No 1	EŞDEĞER NO 2 Equivalent No 2	ÖLÇÜLER MM. Dimensions - MM.					TİP Type	MALZEME Material
046006	FELICIA	ARKA AKS Rear Axle	357501641B	-	12011154	045.772	40,00	52,00	58,00	7,50		SPL3TL	NBR
045938-P	105, 110, 120, 130-RAPID	ARKA AKS Rear Axle	954042107	-	12000725	-	42,00	56,00		7,00		L3L SS-RL	ACM
045560	OCTAVIA-SUPERB-FAVORIT	ARKA AKS Rear Axle	951045108	-	12017052	-	45,00	60,00		7,00		L3L	NBR
040290	105, 110, 120, 130	FREN SİSTEMİ Brake System	954038107	-	12010923	-	38,00	50,00		7,00		L3	NBR

DİFERANSİYEL GRUBU / Differential Group

SKT NO	KULLANILAN MODELLER Models	KULLANIM YERİ Place Of Use	ORJINAL NO 1 Original No 1	ORJINAL NO 2 Original No 2	EŞDEĞER NO 1 Equivalent No 1	EŞDEĞER NO 2 Equivalent No 2	ÖLÇÜLER MM. Dimensions - MM.					TİP Type	MALZEME Material
045902-P	FABIA-FAVORİT-FELICIA	DİFERANSİYEL SAĞ ÇIKIŞ Dif.-Right/Left Output	002301227E	-	12019598	-	40,00	55,00		8,00		L13L SS-RL	ACM
046275-PL	FABIA-OCTAVIA-SUPERB	DİFERANSİYEL SAĞ ÇIKIŞ Dif.-Right/Left Output	02J409528A	02J409528C	01033861	228.490	48,00	60,00	74,00	12,60	26,60	SPL3L SAĞ-Right	ACM
045698-V	FABIA-OCTAVIA-ROOMSTAR-YETİ-SUPERB	DİFERANSİYEL SAĞ-SOL ÇIKIŞ Dif.-Right/Left Output	084409189B	-	07033882 12015555	-	48,00	62,00		8,00		L3L	FKM
046233-P	FABIA-OCTAVIA-SUPERB-ROOM-STER-YETİ	DİFERANSİYEL SAĞ-SOL ÇIKIŞ Dif.-Right/Left Output	02J409189A	02J409189E	12015555	228.480	48,00	62,00		8,00		L3TL SS-RL	ACM
045821-P	FABIA-OCTAVIA-ROOMSTAR-SUPERB-YETİ	DİFERANSİYEL SAĞ-SOL ÇIKIŞ Dif.-Right/Left Output	02T409189C	02T409189C	01031878 12000767	454.260	50,00	65,00		8,00		L3L	ACM
046229-P	FABIA-OCTAVIA-RAPID-SUPERB-1.4 TSI-1.6FSI-1.9-2.0 TDI	DİFERANSİYEL SAĞ-SOL ÇIKIŞ Dif.-Right/Left Output	02T409189	02T409189C	01031878	454.260	50,00	65,00		8,00		L13L SS-RL	ACM
045867-P	FABIA-OCTAVIA-TOLEDO	DİFERANSİYEL SAĞ-SOL ÇIKIŞ Dif.-Right/Left Output	02M409189	-	01033858	-	50,00	65,00		10,00		L3TLL SS-RL	ACM
046276-P	OCTAVIA	DİFERANSİYEL SAĞ-SOL ÇIKIŞ Dif.-Right/Left Output	020301189H	020301189N	12016928	527.858	50,00	65,20		10,00		L3TL SS-RL	ACM
046230-P	FABIA-OCTAVIA-KAROQ-RAPID-SUPERB-YETİ	DİFERANSİYEL SAĞ-SOL ÇIKIŞ Dif.-Right/Left Output	02M301189G	-	01029144	454.820	60,00	74,00		8,00		L13L SS-RL	ACM

ŞANZIMAN GRUBU / Gearbox Group

SKT NO	KULLANILAN MODELLER Models	KULLANIM YERİ Place Of Use	ORJINAL NO 1 Original No 1	ORJINAL NO 2 Original No 2	EŞDEĞER NO 1 Equivalent No 1	EŞDEĞER NO 2 Equivalent No 2	ÖLÇÜLER MM. Dimensions - MM.					TİP Type	MALZEME Material
041311-P	OCTAVIA-FABIA-YETI-ROOMSTAR	ŞANZIMAN ÖN-AUTO. Gearbox Front-Automatic	0AM 301 733 K	0AM 301 733 H	01035820	908.420	20,50	28,00		7,00		L13L SS-RL	ACM
041062-P	FABIA-OCTAVIA-ROOMSTAR-SUPERB-YETI	ŞANZIMAN ÖN Gearbox Front	085311113	-	12015554	191.320	21,80	35,00		7,00		L3TL SAĞ -Right	ACM
040943-P	FABIA-FAVORİT-FELICIA-OCTAVIA	ŞANZIMAN ÖN Gearbox Front	002301227A	-	01025576	-	22,00	32,00		7,00		L13TL SAĞ -Right	ACM
041315-P	OCTAVIA I	ŞANZIMAN ÖN Gearbox Front	020311113B	-	12016924	-	23,90	40,00		8,00		L3TL SAĞ -Right	ACM
041275-P	FABIA-OCTAVIA-YETİ-SUPERB-ROOM-STAR	ŞANZIMAN ÖN Gearbox Front	02T311113A	-	01026708	870.310	24,00	38,00		6,00		L3T SAĞ -Right	ACM
040738-P	FABIA-OCTAVIA-YETI-SUPERB	ŞANZIMAN ÖN Gearbox Front	2M311113	2M311113A	12016518	546.970	28,00	42,00		7,00		L3TL SAĞ -Right	ACM
040738-V	FABIA-OCTAVIA-YETI-SUPERB	ŞANZIMAN ÖN Gearbox Front	2M311113	2M311113A	16012080	546.970	28,00	42,00		7,00		L3TL SAĞ -Right	FKM
046226-P	SUPERB II 2.0 TDI	ŞANZIMAN ARKA Gearbox Rear	-	-	01031902	82031902	42,00	62,00		8,00		L13TL SOL -Left	ACM
040748-V	OCTAVIA	VİTES SEÇİCİ MILİ Gear Selection Shaft	020311108A	020311108G	01020437	322.415	8,00	14,00		4,00		L13	FKM
040690	FABIA	VİTES SEÇİCİ MILİ Gear Selection Shaft	002301227G	-	12000444	-	15,00	24,00		7,00		L3L	NBR
040838	OCTAVIA	VİTES SEÇİCİ MILİ Gear Selection Shaft	020301227F	020301227D	01019317	-	18,00	30,00		6,40	8,00	L3BTL	NBR

DİREKSİYON GRUBU / Steering Group

SKT NO	KULLANILAN MODELLER Models	KULLANIM YERİ Place Of Use	ORJINAL NO 1 Original No 1	ORJINAL NO 2 Original No 2	EŞDEĞER NO 1 Equivalent No 1	EŞDEĞER NO 2 Equivalent No 2	ÖLÇÜLER MM. Dimensions - MM.					TİP Type	MALZEME Material
041132-V	-	DİREKSİYON POMPA Steering Pump	077008434	-	15020025	-	19,00	32,00		7,00		L3BTL	FKM
041134	FELICIA	DİREKSİYON KUTUSU Steering Box	-	-	12012530	-	19,00	34,60		6,20	9,20	L3BL	NBR
041128	FELICIA	DİREKSİYON KUTUSU Steering Box	-	-	12012050	-	23,00	34,30		6,35		L3B	NBR
041124	FELICIA	DİREKSİYON KUTUSU Steering Box	-	-	12014254	-	23,30	29,70		4,00		L2	NBR

DİREKSİYON GRUBU / Steering Group

SKT NO	KULLANILAN MODELLER Models	KULLANIM YERİ Place Of Use	ORJİNAL NO 1 Original No 1	ORJİNAL NO 2 Original No 2	EŞDEĞER NO 1 Equivalent No 1	EŞDEĞER NO 2 Equivalent No 2	ÖLÇÜLER MM. Dimensions - MM.					TİP Type	MALZEME Material
041123-H	OCTAVIA	DİREKSİYON KUTUSU Steering Box	-	-	01016892	-	24,00	33,00		5,00		L3BTI	HNBR
041204-H	OCTAVIA	DİREKSİYON KUTUSU Steering Box	7891033104	-	01019952	-	24,00	37,00		8,50		L3B	HNBR
041212-NL	OTOMOBİL SERİSİ	DİREKSİYON KUTUSU Steering Box	7891033104	-	01019952	-	24,00	37,00		8,50		L3BTI	NBR+TPU
041203-H	OCTAVIA	DİREKSİYON KUTUSU Steering Box	7891033105	-	01016893	-	24,00	39,00		8,50		L3B	HNBR
041118-H	OCTAVIA (ZF TİP KUTU)	DİREKSİYON KUTUSU Steering Box	0770080425	0770198107	01016891	-	28,00	37,00		5,00		L3BT	HNBR
040849	EM	DİREKSİYON SİSTEMİ Steering System	113415297	-	19015771	164.500	28,00	40,00		6,00		L3BTL	NBR
041251-NL	FELICIA	HİDROLİK DİREKSİYON KUTUSU Power Steering Box	-	-	12012051	-	23,00	34.43	38,00	3,70	7,50	LL3TL	NBR+TPU

MOTOR GRUBU / Engine Group

SKT NO	KULLANILAN MODELLER Models	KULLANIM YERİ Place Of Use	ORJINAL NO 1 Original No 1	ORJINAL NO 2 Original No 2	EŞDEĞER NO 1 Equivalent No 1	EŞDEĞER NO 2 Equivalent No 2	ÖLÇÜLER MM. Dimensions - MM.					TİP Type	MALZEME Material
040944-V	SX4	KRANK ÖN Crank Shaft Front	1612479J50	-	12018321	069.590	31,00	41,00		7,00		L13TL SAĞ- Right	FKM
041116-FP	JIMNY-SWIFT II	KRANK ÖN Crank Shaft Front	1611484A00		20034106	431.420	35,00	47,00		7,00		F2TL SAĞ- Right	PTFE+ACM
046122-V	IGNIS-SWIFT 1.3 DDİS	KRANK ÖN Crank Shaft Front	1611485E00	-	12019250 01029649	445.060	40,00	52,00		7,00		L13TL SAĞ- Right	FKM
046119-FP	OTOMOBİL SERİSİ	KRANK ÖN Crank Shaft Front	1612273J00		20029116	026.750	40,00	55,00		6,40		F2TL SAĞ- Right	PTFE+ACM
046161-V	VITARA-SX4-SWIFT-JIMNY	KRANK ÖN Crank Shaft Front	928341001	-	19034959	351.180 717.710	41,00	53,00		6,00		L3L SAĞ- Right	FKM
045968-V	OTOMOBİL SERİSİ	KRANK ÖN Crank Shaft Front	1611466G00		20015456	040.363	42,00	62,00		7,00		L13TL SAĞ- Right	FKM
047838-FP	SWIFT-SPLASH-IGNIS-WAGON DDİS	KRANK ARKA Crank Shaft Rear	161285E00	-	20032405	428.970	78,00	100,00		9,00		F2TL SOL- Left	PTFE+ACM
047645-V	SWIFT-SPLASH-IGNIS-WAGON DDİS	KRANK ARKA Crank Shaft Rear	161285E00	-	20032405	428.970	78,00	100,00		10,00		L13TL SOL- Left	FKM
410443-FP	OTOMOBİL SERİSİ	KRANK ARKA Crank Shaft Rear	1612173J00		20029117	026.790	85,00	105,00		8,80		F2TL SOL- Left	PTFE+ACM
410382-V	BALENO-SAMURAI-VITARA	KRANK ARKA Crank Shaft Rear	1612166G10	-	20015455	81-36556-00	90,00	110,00		7,00		L3TL SOL- Left	FKM
415185-V	SX4	KRANK ARKA Crank Shaft Rear	1134179J50	-	12015763	199.191	93,00	140,00	172,00	15,00		SPL1L SOL- Left	FKM
041151-FP	SX4-LIANA	EKSANTRİK MİLİ Cam Shaft	1274673J00		20029115	813414400	27,00	47,00		7,00		F2TL SAĞ- Right	PTFE+ACM
041256-V	GRAND VITARA 2.0 HDI	EKSANTRİK MİLİ Cam Shaft	1274667G00	-	20026123	153.740	27,00	47,00		7,00		L3TL SAĞ- Right	FKM
041115-V	JIMNY JEEP	EKSANTRİK MİLİ Cam Shaft	7701471376	13042BN700	12018754	073.890	28,00	42,00		5,00		L3TL SAĞ- Right	FKM
041247-V	1.6-1.9-2.0 MJTD-JTDM-SX4	EKSANTRİK MİLİ Cam Shaft	-	-	12018345	434.500	30,00	45,00		7,00		L13TL SAĞ- Right	FKM
45-045-V	SWIFT-SPLASH-IGNIS- DDİS	SUPAP Valve Stem Seal	1291985E0000	-	12016586 49472882	069.630 70-33512-00	6,00	8,80	11,70	9,50		LSY2T	FKM
45-025-V	JIMNY 1.2-1.4-1.6 MOT.	SUPAP Valve Stem Seal	036109675	036109675A	724.590	724.590 70-33512-00	6,00	8,80	12,20	9,70		LSY2T	FKM
45-068-V	GRAND VITARA 2.0 HDI DW10	SUPAP Valve Stem Seal	1291967G00	-	12016913	136.940	6,00	10,00	19,60	21,50		LSY5T	FKM
45-021-V	BALENO-SX4-VITARA	SUPAP Valve Stem Seal	1291979J50	-	12014584 49472013	294.110	8,00	10,80	14,20	5,50	10,00	LSY2T	FKM

DİFERANSİYEL GRUBU / Differential Group

SKT NO	KULLANILAN MODELLER Models	KULLANIM YERİ Place Of Use	ORJINAL NO 1 Original No 1	ORJINAL NO 2 Original No 2	EŞDEĞER NO 1 Equivalent No 1	EŞDEĞER NO 2 Equivalent No 2	ÖLÇÜLER MM. Dimensions - MM.				TİP Type	MALZEME Material	
040756	IGNIS-SJ410-WAGON R 1.2-1.3 16V	DİFERANSİYEL ÖN-MAHRUTİ Differential Front-Bevelgear	0928328022	-	19027774	12011130	28,00	47,00		7,00		L3L	NBR
041276-PF	OTOMOBİL SERİSİ	DİFERANSİYEL SAĞ-SOL ÇIKIŞ Dif.-Right/Left Output	2743173JA0	-	20028963	505.090	29,90	47,00		11,30		L3TF SS-RL	ACM+PTFE
040747-V	OTOMOBİL SERİSİ	DİFERANSİYEL ÖN-MAHRUTİ Differential Front-Bevelgear	1137886CA0	1274666G00	20018100	81-25451-10	35,00	50,00		7,00		L3TL SAĞ	FKM
045894-P	OTOMOBİL SERİSİ	DİFERANSİYEL SAĞ-SOL ÇIKIŞ Dif.-Right/Left Output	2743160G10	-	19033964	-	35,00	54,00		9,50	13,50	L3LR SS-RL	ACM
045883	OTOMOBİL SERİSİ	DİFERANSİYEL SAĞ-SOL ÇIKIŞ Dif.-Right/Left Output		-	12017376	452.500	35,00	54,00		10,00	15,00	L13TLR SS	NBR
045704	IGNIS-SX4-WAGON R	DİFERANSİYEL SAĞ-SOL ÇIKIŞ Dif.-Right/Left Output	0928340028	2917260G90	19027780	-	40,00	58,00		10,00		L3L	NBR

ŞANZİMAN GRUBU / Gearbox Group

SKT NO	KULLANILAN MODELLER Models	KULLANIM YERİ Place Of Use	ORJINAL NO 1 Original No 1	ORJINAL NO 2 Original No 2	EŞDEĞER NO 1 Equivalent No 1	EŞDEĞER NO 2 Equivalent No 2	ÖLÇÜLER MM. Dimensions - MM.				TİP Type	MALZEME Material	
040789-V	OTOMOBİL SERİSİ	ŞANZİMAN Gearbox	1274679J50	-	12011839	598.760	30,00	42,00		7,00		L3T SAĞ -Right	FKM
045565	CARRY 1.3 16V	ŞANZİMAN Gearbox	2737153F00	-	12011146	706.035	35,00	55,00		11,00		L3L	NBR
045609-P	OTOMOBİL SERİSİ	ŞANZİMAN-OTM. Gearbox-Auto.	2473272C00	-	19026746	-	45,00	62,00		10,00		L3 SAĞ -Right	ACM

AKS GRUBU / Axle Group

SKT NO	KULLANILAN MODELLER Models	KULLANIM YERİ Place Of Use	ORJINAL NO 1 Original No 1	ORJINAL NO 2 Original No 2	EŞDEĞER NO 1 Equivalent No 1	EŞDEĞER NO 2 Equivalent No 2	ÖLÇÜLER MM. Dimensions - MM.				TİP Type	MALZEME Material	
045704	IGNIS-SX4	ÖN AKS Front Axle	0928340028	2917260G90	19027780	-	40,00	58,00		10,00		L3L	NBR

MOTOR GRUBU / Engine Group

SKT NO	KULLANILAN MODELLER Models	KULLANIM YERİ Place Of Use	ORJINAL NO 1 Original No 1	ORJINAL NO 2 Original No 2	EŞDEĞER NO 1 Equivalent No 1	EŞDEĞER NO 2 Equivalent No 2	ÖLÇÜLER MM. Dimensions - MM.					TİP Type	MALZEME Material
041250-V	AURIS-AVENSIS-COROLLA-RAV4-VERSO-YARIS	KRANK ÖN Crank Shaft Front	90311W0012	-	20018317	135.140 81-34146-00	38,00	50,00		6,00		L3TL SAĞ -Right	FKM
040801-V	AVENSIS-COROLLA-AURIS 1.4-1.6-1.8 VVTI-RAV4-YARIS	KRANK ÖN Crank Shaft Front	9031138089	9031138078	19026739	19016535	38,00	50,00		8,00		L13L SAĞ -Right	FKM
046007-V	RAV4-CAMRY	KRANK ÖN Crank Shaft Front	9031142043	90311A0019	12018755	157.200 981.480	42,00	54,00		6,00		L3TL SAĞ -Right	FKM
045728-P	CORONA-COROLLA-LAND CRUISER-HILUX	KRANK ÖN Crank Shaft Front	9031142003	9031142012	07011550 19015085	15019600	42,00	60,00		8,00		L3T SAĞ -Right	ACM
047675-V	AVENSIS-COROLLA-CARINA 1.3-1.6	KRANK ARKA Crank Shaft Rear	9031170007	-	19026767	135.420	70,00	92,00		8,50		L3L SOL -Left	FKM
047676-V	COROLLA 1.3-1.4-1.6	KRANK ARKA Crank Shaft Rear	9031175004	9031175009	19016539	NJ407	75,00	100,00		8,50		L13L SOL -Left	FKM
410496-V	COROLLA-AURIS-YARIS-VERSO 1.5-1.4 D4D MOT.	KRANK ARKA Crank Shaft Rear	9008031094	9031175016	19026734	575.450	75,00	107,00		8,00		L3TL SOL -Left	FKM
047650-V	COROLLA-HILUX-SUPRA	KRANK ARKA Crank Shaft Rear	9031180003	9031180007	12015352	507.822 81-18304-50	80,00	100,00		8,00		L3TL SOL -Left	FKM
040931-V	HILUX-AVENSIS-HIACE-LAND CRUISER COROLLA 1.3-1.6I-1.8 16V	EKSANTRİK MİLİ-ARKA Cam Shaft-Rear	9031132020	903132018	19026736	777.471	32,00	46,00		6,00		L3L SAĞ -Right	FKM
040815-V	CARINA 1.6 16V	EKSANTRİK MİLİ Cam Shaft	9031135023	-	20011244	353.990 81-24909-10	35,00	48,00		7,00		L13TL SAĞ -Right	FKM
040803-P	AVENSIS-COROLLA-CORONA 1.3-1.6I-1.816V-YARIS	EKSANTRİK MİLİ Cam Shaft	9031135022	9031138078	19016638	010.360	35,00	49,00		6,00		L3L SAĞ -Right	ACM
040803-V	COROLLA 1.3-1.4-1.6 MOT.	EKSANTRİK MİLİ Cam Shaft	9004311435 9031135035	9031135021	19026732	010.360	35,00	49,00		6,00		L3L SAĞ -Right	FKM
040747-V	AVENSIS-COROLLA	EKSANTRİK MİLİ Cam Shaft	SU00100084	-	20018100	757.292	35,00	50,00		7,00		L3TL SAĞ -Right	FKM
041250-V	AURIS-AVENSIS-COROLLA-RAV4-VERSO-YARIS	EKSANTRİK MİLİ Cam Shaft	90311W0012	-	20018317	135.140 81-34146-00	38,00	50,00		6,00		L3TL SAĞ -Right	FKM
046217-V	OTOMOBİL SERİSİ	EKSANTRİK MİLİ Cam Shaft	9008031034	9031140006	12016528 46085500	290.710	40,00	55,00		7,00		L13TL SAĞ -Right	FKM
45-022-V	AVENSIS-COROLLA 1.3-1.6 2E	SUPAP Valve Stem Seal	9091302090	2222422000	19027767 19018204	49472839	5,50	11,00	13,50	6,50	10,15	LSYT	FKM
45-069-V	AURIS-AVENSIS-COROLLA-HILUX-RAV4-YARIS-1.4-2.0-2.5 D-4D MOT.	SUPAP Valve Stem Seal	9091302121	-	19034020 49472803	12020300	6,00	11,00		6,00	11,20	LSY	FKM

AKS GRUBU / Axle Group

SKT NO	KULLANILAN MODELLER Models	KULLANIM YERİ Place Of Use	ORJINAL NO 1 Original No 1	ORJINAL NO 2 Original No 2	EŞDEĞER NO 1 Equivalent No 1	EŞDEĞER NO 2 Equivalent No 2	ÖLÇÜLER MM. Dimensions - MM.				TİP Type	MALZEME Material	
045653	HILUX-HIACE	ÖN AKS İÇ Front Axle Inner	9031050001	J9031050001	19017040	1041P	50,00	70,00		9,00		L1L	NBR
045888	COROLLA 1.3-1.6	ÖN AKS İÇ Front Axle Inner	9031152006	-	19016648	-	52,00	66,00		7,50	12,00	L1LR	NBR
045889	COROLLA 1.3-1.6	ÖN AKS DIŞ Front Axle Outer	9031156008	-	19016651	-	56,00	73,00		8,00	12,50	L1LR	NBR
045890	COROLLA 1.3-1.4-1.6	ARKA AKS Rear Axle	9031141003	9031142007	19016643	-	41,00	55,00		6,00		L1L	NBR
045802	CORONA-CARINA-CELICA-COROLLA 1.6	ARKA AKS Rear Axle	9031152059	9004311250	19016649	-	52,00	65,00		9,00		L1L	NBR

DİFERANSİYEL GRUBU / Differential Group

SKT NO	KULLANILAN MODELLER Models	KULLANIM YERİ Place Of Use	ORJINAL NO 1 Original No 1	ORJINAL NO 2 Original No 2	EŞDEĞER NO 1 Equivalent No 1	EŞDEĞER NO 2 Equivalent No 2	ÖLÇÜLER MM. Dimensions - MM.				TİP Type	MALZEME Material	
045734	CORONA-COROLLA 1.6-1.8	DİFERANSİYEL ÖN-MAHRUTİ Differential Front-Bevelgear	9031138014	9031138124	19016534	NJ017	38,00	65,00		12,00	19,50	LL12R	NBR
045652	CORONA-HIACE-LAND CRUISER	DİFERANSİYEL ÖN-MAHRUTİ Differential Front-Bevelgear	9031138003	9031138010	19016639	1170PRD	38,00	74,00		11,00		L1L SAĞ -Right	NBR
045886-P	AVENSIS-COROLLA-AURIS 1.3-1.4-1.6 VVTI-YARIS	DİFERANSİYEL SAĞ ÇIKIŞ Dif.-Right Output	9031134016	9031134033	19026773	1032PRDA	34,00	54,00		9,00	15,50	L3LR SAĞ -Right	ACM
045887-P	AVENSIS-COROLLA-1.3	DİFERANSİYEL SOL ÇIKIŞ Differential Left Output	9031134028	9031134017	19034041	-	34,00	63,00		9,00	15,50	L3LR SOL -Left	ACM
046001-P	AVENSIS-CORONA-CARINA-COROLLA 2.0 16V	DİFERANSİYEL SAĞ-SOL ÇIKIŞ Dif.-Right/Left Output	9031135033	9031135026	19026774	1037PIAC	35,00	55,00		9,00	15,50	L3LR SS- RL	ACM
046250-P	HILUX-LAND CRUISER SERİSİ	DİFERANSİYEL SAĞ-SOL ÇIKIŞ Dif.-Right/Left Output	9031141009	-	19034729	82034729	41,00	74,00		11,00	18,50	L3LR SS- RL	ACM

ŞANZIMAN GRUBU / Gearbox Group

SKT NO	KULLANILAN MODELLER Models	KULLANIM YERİ Place Of Use	ORJINAL NO 1 Original No 1	ORJINAL NO 2 Original No 2	EŞDEĞER NO 1 Equivalent No 1	EŞDEĞER NO 2 Equivalent No 2	ÖLÇÜLER MM. Dimensions - MM.					TİP Type	MALZEME Material
040884	COROLLA	ŞANZIMAN ÖN Gearbox Front	SU00100208	-	07015547	131.860	23,00	36,00		7,00		L3TL SAĞ -Right	NBR
040802	AVENSIS-COROLLA-CARINA-YARIS- RAW4 1.3-1.6-1.8	ŞANZIMAN ÖN Gearbox Front	9031125016	9031125011	19016634	1036PRD	25,00	37,00		8,00		L3L SAĞ -Right	NBR
040880-P	AVENSIS-AURIS-COROLLA- 2.016V-2.2 D-RAV4	ŞANZIMAN ÖN Gearbox Front	9031130006	9031130017	12010674	277.142 440.720	30,00	42,00		7,00		L3TL SAĞ -Right	ACM
040604	CORONA-COROLLA 1.8-HIACE	ŞANZIMAN ÖN Gearbox Front	9031130010	9031130115	19015048	-	30,00	45,00		8,00		L3L	NBR
045651	CORONA-COROLLA 1.8	ŞANZIMAN ARKA Gearbox Rear	9031138043	9031138005	19016642	NJ609	38,00	58,00		11,00		L1L	NBR
045698-V	LAND CRUISER	ŞANZIMAN ARKA 4x4 Gearbox Rear 4x4	9031148016	-	19017582	-	48,00	62,00		8,00		L3L	FKM
040373	AVENSIS-COROLLA-RAV4- YARIS-CARINA	VİTES SEÇİCİ MİLİ Gear Selection Shaft	9031118013	-	19032403	-	18,00	28,00		7,00		L3	NBR

DİREKSİYON GRUBU / Steering Group

SKT NO	KULLANILAN MODELLER Models	KULLANIM YERİ Place Of Use	ORJINAL NO 1 Original No 1	ORJINAL NO 2 Original No 2	EŞDEĞER NO 1 Equivalent No 1	EŞDEĞER NO 2 Equivalent No 2	ÖLÇÜLER MM. Dimensions - MM.					TİP Type	MALZEME Material
041126	COROLLA-CORONA	DİREKSİYON KUTUSU Steering Box	0770080273	0770198130	01016544	-	20,00	30,00		5,00	6,00	L3BTL	NBR
041128	COROLLA	DİREKSİYON KUTUSU Steering Box	-	-	12012050	-	23,00	34,30		6,35		L3B	NBR
041120	COROLLA-CORONA	DİREKSİYON MİLİ Steering Shaft	-	-	01019875	-	26,00	35,00		7,00		SPL3B	NBR
041132-V	COROLLA-CORONA	DİREKSİYON POMPA Steering Pump	077008434	-	15020025	-	19,00	32,00		7,00		L3BTL	FKM
041320	COROLLA-AURIS	HİDROLİK DİREKSİYON Steering Box	9031119006	9031119002	19016677	82016677	19,00	32,00		7,00	8,00	L3BTL	NBR

MOTOR GRUBU / Engine Group

SKT NO	KULLANILAN MODELLER Models	KULLANIM YERİ Place Of Use	ORJINAL NO 1 Original No 1	ORJINAL NO 2 Original No 2	EŞDEĞER NO 1 Equivalent No 1	EŞDEĞER NO 2 Equivalent No 2	ÖLÇÜLER MM. Dimensions - MM.				TİP Type	MALZEME Material	
040944-V	PASSAT 2.0-GOLF II-III	KRANK ÖN Crank Shaft Front	5646262	7628850	12018321	069.590	31,00	41,00		7,00		L13TL SAÇ -Right	FKM
041272-FP	BORA-CADDY-GOLF-JETTA-PASSAT-CRAFTER-TIGAN-TIGUAN	KRANK ÖN Crank Shaft Front	038103085C	038103085A	20026413	129.780	32,00	47,00		10,00		F2TL SAÇ -Right	PTFE+ACM
040969-V	BORA-LT-PASSAT-POLO-TRANSPORTER-CADDY 1.9 TDI-ALH	KRANK ÖN Crank Shaft Front	0544115147B	034115137A	12010739	294.357 475.961	35,00	48,00		10,00		L3TL SAÇ -Right	FKM
041273-FP	GOLF-POLO-BORA-JETTA-PASSAT-CADDY-TRANSPORTER	KRANK ÖN Crank Shaft Front	038103085	038103085B	20026412	155.560	35,00	48,00		10,00		F2TL SAÇ -Right	PTFE+ACM
047650-V	PASSAT-TRANSPORTER	KRANK ARKA Crank Shaft Rear	1218389	-	20027765	128.210 81-18304-50	80,00	100,00		10,00		L3TL SOL -Left	FKM
410276-V	POLO 1.4-1.6-PASSAT 1.9TDI-APQ	KRANK ARKA Crank Shaft Rear	026103051B	047103085A	12012347 12015424	508-462 81-23708-50	85,00	105,00		12,00		L3TL SOL -Left	FKM
415242-FAEK	BORA-GOLF-PASSAT-POLO-TOURAN 1.6-1.6İ-1.8-2.0 BEN.MT.	KRANK ARKA Crank Shaft Rear	06B103171B	06B103171D	20019557	012.380	85,00	131,00	152,00	15,70		SP F AL8	PTFE+ ACM+YÜN
041310-FP	POLO-JETTA-GOLF-SCIROCCO-JETTA-PASSAT-1.0-1.2-1.4 TFSI	EKSANTRİK MİLİ-ARKA Cam Shaft-Rear	04E 103 085	04E103085AC	20037127	242.620	24,00	39,00		8,00		F2TL SOL -Left	PTFE+ACM
041278-FP	TOURAN 1T1-1T2 SERİSİ	EKSANTRİK MİLİ Cam Shaft	-	-	20035460	584.880 81-38506-00	28,00	42,00		6,00		F2TL SAÇ -Right	PTFE+ACM
041309-V	POLO-FOX 1.4-1.6 MOT.	EKSANTRİK MİLİ Cam Shaft	036 103 085 H	036103085C	19036807	158.060	32,00	42,00		6,00	7,00	L13TL SAÇ -Right	FKM
040946-V	GOLF-POLO-BORA-PASSAT-CADDY-TRANSPORTER	EKSANTRİK MİLİ Cam Shaft	068103085E	068103085G	20015850	325.155 325.156	32,00	47,00		10,00		L3TL SS- RL	FKM
041272-FP	GOLF-POLO-BORA-JETTA-PASSAT-CADDY-TRANSPORTER-VENTO	EKSANTRİK MİLİ Cam Shaft	038103085C	038103085A	20026413	129.780	32,00	47,00		10,00		F2TL SAÇ -Right	PTFE+ACM
041267-FP	CRAFTER 30-35	EKS.MİLİ-VANOS Cam Shaft - Vanos System	8200168254	7701474363	19036652	505.600 81-38507-00	33,00	42,00		6,00		F2TL SAÇ -Right	PTFE+ACM
041308-FP	GOLF-BEETLE-CADDY-PASSAT-POLO-TIGUAN-1.0-1.2-1.4-1.5 TFSI-TSI	EKSANTRİK MİLİ Cam Shaft	04E 103 085 B	04E 103 085 AF	242.650	-	36,00	46,00		7,00		F2TL SAÇ -Right	PTFE+ACM
45-025-V	GOLF-BORA-JETTA-PASSAT-CADDY	SUPAP Valve Stem Seal	036109675A	036109675	12014670	724.590 70-33512-00	6,00	8,80	12,20	9,70		LSY2T	FKM
45-033-V	GOLF-POLO-BORA-JETTA-PASSAT-CADDY-TRANSPORTER	SUPAP Valve Stem Seal	027109675	-	12014671	701.289 70-26058-00	7,00	9,80	13,20	9,70		LSY2T	FKM
45-064-V	LT 28-35 SERİSİ	SUPAP Valve Stem Seal	-	-	12014586	830.489	7,00	10,00	13,50	8,50		LSY2T	FKM
45-021-V	GOLF-PASSAT 1.4-1.6-1.8	SUPAP Valve Stem Seal	026109675	035109675 056109675	12014584 49472013	294.110	8,00	10,80	14,20	10,00		LSY2T	FKM

AKS GRUBU / Axle Group

SKT NO	KULLANILAN MODELLER Models	KULLANIM YERİ Place Of Use	ORJINAL NO 1 Original No 1	ORJINAL NO 2 Original No 2	EŞDEĞER NO 1 Equivalent No 1	EŞDEĞER NO 2 Equivalent No 2	ÖLÇÜLER MM. Dimensions - MM.					TİP Type	MALZEME Material
046006	GOLF-POLO-PASSAT-CADDY	ARKA AKS Rear Axle	357501641	-	12011154	045.772	40,00	52,00	58,00	7,50		SPL3TL	NBR
046131	LT25-35 2,4-D-TD	ARKA AKS Rear Axle	281501317	-	12013928	16018444	55,00	70,00		8,00		L3LL SS- RL	NBR
047695	LT25-35 2,4-D-TD	ARKA AKS Rear Axle	291501317	-	12013927	046.904	65,00	85,00		10,00		L3TL	NBR

DİFERANSİYEL GRUBU / Differential Group

SKT NO	KULLANILAN MODELLER Models	KULLANIM YERİ Place Of Use	ORJINAL NO 1 Original No 1	ORJINAL NO 2 Original No 2	EŞDEĞER NO 1 Equivalent No 1	EŞDEĞER NO 2 Equivalent No 2	ÖLÇÜLER MM. Dimensions - MM.					TİP Type	MALZEME Material
046228-P	PASSAT 1.4 TSI	DİFERANSİYEL ÖN-MAHRUTİ Differential Front-Bevelgear	-	-	01019477	268.420	37,00	61,00		10,00	14,00	L13TLR SAĞ-Right	ACM
046025-VP	LT 28-35 SERİSİ	DİFERANSİYEL ÖN-MAHRUTİ Differential Front-Bevelgear	2D0501317	-	01019478	398.420	40,00	70,00		13,00	20,00	SPL13LR SS-RL	FKM+ACM
045884-V	BORA	DİFERANSİYEL SAĞ ÇIKIŞ Dif.-Right/Left Output	71734264	55707298	01033292	-	35,00	54,90	61,00	9,00	14,70	SPL1L SS-RL	FKM
046275-PL	GOLF-CADDY-BORA-BEETLE	DİFERANSİYEL SAĞ ÇIKIŞ Dif.-Right/Left Output	02J409528A	02J409528C	01033861	228.490	48,00	60,00	74,00	12,60	26,60	SPL3L SAĞ-Right	ACM+NYL
045698-V	BORA-CADDY-GOLF-JETTA	DİFERANSİYEL SOL ÇIKIŞ Differential Left Output	02J409189A	-	07033882 12015555	-	48,00	62,00		8,00		L3L	FKM
045902-P	LUPO-CADDY II	DİFERANSİYEL SAĞ-SOL ÇIKIŞ Dif.-Right/Left Output	002301227E	-	12019598	-	40,00	55,00		8,00		L13L SS- RL	ACM
046233-P	BORA-CADDY-GOLF-JETTA-PASSAT- POLO-TOURAN-VENTO	DİFERANSİYEL SAĞ-SOL ÇIKIŞ Dif.-Right/Left Output	02J409189A	02J409189B	12015555	228.480	48,00	62,00		8,00		L3TL SS- RL	ACM
045821-P	BORA-CADDY-GOLF-JETTA-PAS- SAT-TIGUAN-TRANSPORTER	DİFERANSİYEL SAĞ-SOL ÇIKIŞ Dif.-Right/Left Output	02T409189C	02T409189C	01031878 12000767	454.260	50,00	65,00		8,00		L3L	ACM
046229-P	CADDY-GOLF-PASSAT-POLO-TRANS- PORTER 1.4 TSI-1.6FSI-1.9-2.0TDI	DİFERANSİYEL SAĞ-SOL ÇIKIŞ Dif.-Right/Left Output	02T409189	02T409189C	01031878	454.260	50,00	65,00		8,00		L13L SS- RL	ACM
045867-P	BORA-GOLF IV-NEW BEETLE	DİFERANSİYEL SAĞ-SOL ÇIKIŞ Dif.-Right/Left Output	02M409189	-	01033858	-	50,00	65,00		10,00		L3TLL SS-RL	ACM
046276-P	BORA-GOLF-CADDY	DİFERANSİYEL SAĞ-SOL ÇIKIŞ Dif.-Right/Left Output	020301189T	020301189H	12016928	527.858	50,00	65,20		10,00		L3TL SS- RL	ACM
046230-P	BORA-CADDY-GOLF-PASSAT-PO- LO-TIGUAN-TRANSPORTER	DİFERANSİYEL SAĞ-SOL ÇIKIŞ Dif.-Right/Left Output	02M301189L	-	01029144	454.820	60,00	74,00		8,00		L13L SS- RL	ACM

ŞANZIMAN GRUBU / Gearbox Group

SKT NO	KULLANILAN MODELLER Models	KULLANIM YERİ Place Of Use	ORJINAL NO 1 Original No 1	ORJINAL NO 2 Original No 2	EŞDEĞER NO 1 Equivalent No 1	EŞDEĞER NO 2 Equivalent No 2	ÖLÇÜLER MM. Dimensions - MM.				TİP Type	MALZEME Material	
040862	EM-OLD MODELS	ŞANZIMAN ÖN Gearbox Front	0948350355	5000809532	12010825	106.208	20,00	35,00		7,00	L3TL	NBR	
041311-P	TÜM VW MODELLERİ 1.4TSI, 1.6TDI	ŞANZIMAN ÖN-AUTO. Gearbox Front-Automatic	0AM 301 733 K	-	01035820	908.420	20,50	28,00		7,00	L13L SS-RL	ACM	
041062-P	GOLF-POLO-BORA-JETTA-PASSAT-CADDY-TRANSPORTER-TOURAN	ŞANZIMAN ÖN Gearbox Front	085311113	-	12015554	191.320	21,80	35,00		7,00	L3TL SAĞ -Right	ACM	
041270-P	CADDY-GOLF-JETTA-POLO-SCIROC-CO-VENTO 1.5-1.6	ŞANZIMAN ÖN Gearbox Front	20311113	-	12017266	244.040	21,90	40,00		8,00	L3TL SAĞ -Right	ACM	
040943-P	LUPO 1.4-1.6-1,9D - CADDY	ŞANZIMAN ÖN Gearbox Front	002301227A	959022407	01025576	-	22,00	32,00		7,00	L13TL SAĞ -Right	ACM	
041199-V	GOLF 1.4-APY-CED	ŞANZIMAN ÖN Gearbox Front	084311113A	-	12015553	440.710	23,00	35,00		7,00	L13L SAĞ -Right	FKM	
041315-P	BORA-CADDY-GOLF-POLO-OCTAVIA-IBIZA-LEON-TOLEDO	ŞANZIMAN ÖN Gearbox Front	020311113B	-	12016924	-	23,90	40,00		8,00	L3TL SAĞ -Right	ACM	
041275-P	BORA-CADDY-GOLF-JETTA-PASSAT-POLO-TOURAN-LUPO	ŞANZIMAN ÖN Gearbox Front	02T311113A	-	01026708	870.310	24,00	38,00		6,00	L3T SAĞ -Right	ACM	
040738-P	GOLF-POLO-BORA- 1.9 TDI-PAS-SAT-CADDY 2.0 TDI-KDM	ŞANZIMAN ÖN Gearbox Front	2M311113	2M311113A	12016518	549.970	28,00	42,00		7,00	L3TL SAĞ -Right	ACM	
040738-V	GOLF-POLO-BORA- 1.9 TDI-PAS-SAT-CADDY 2.0 TDI-KDM	ŞANZIMAN ÖN Gearbox Front	2M311113	2M311113A	16012080	549.970	28,00	42,00		7,00	L3TL SAĞ -Right	FKM	
046272-P	PHAETON	ŞANZIMAN ÖN Gearbox Front	09E321243	-	01031573	519.540	45,00	58,00		7,00	L3TL SAĞ -Right	ACM	
046253-V	PASSAT B7	ŞANZIMAN ARKA Gearbox Rear	0149973547	2109970546	01019285	82019285	40,00	55,00		8,00	L13TL SOL -Left	FKM	
040748-V	BORA-CADDY-GOLF	VİTES SEÇİCİ MİLİ Gear Selection Shaft	020311108A	020311109G	01020437	322.415	8,00	14,00		4,00	L13	FKM	
041279-P	GOLF V 1.4 16V	VİTES SEÇİCİ MİLİ Gear Selection Shaft	-	-	01029717	-	12,00	18,00		5,60	L13TL	ACM	
040838	CADDY 1.6-1.6D	VİTES SEÇİCİ MİLİ Gear Selection Shaft	020301227F	020301227D	01019317	-	18,00	30,00		6,40	8,00	L3BTL	NBR
041177	HAFİF TİCARİ	VİTES SEÇİCİ MİLİ Gear Selection Shaft	0634300302	-	12014616	038.083	25,00	35,00		7,00	L13TL	NBR	

DİREKSİYON GRUBU / Steering Group

SKT NO	KULLANILAN MODELLER Models	KULLANIM YERİ Place Of Use	ORJINAL NO 1 Original No 1	ORJINAL NO 2 Original No 2	EŞDEĞER NO 1 Equivalent No 1	EŞDEĞER NO 2 Equivalent No 2	ÖLÇÜLER MM. Dimensions - MM.				TİP Type	MALZEME Material	
041132-V	ZF MODEL	DİREKSİYON POMPA Steering Pump	077008434	-	15020025	-	19,00	32,00		7,00		L3BTL	FKM
041201	CADDY-POLO-PASSAT GOLF	DİREKSİYON MİLİ Steering Shaft	-	-	12015526	-	19,05	34,60		4,40	5,90	L3BTL	NBR
041128	PASSAT-POLO-CADDY-GOLF-TRW	DİREKSİYON KUTUSU Steering Box	-	-	12012050	-	23,00	34,30		6,35		L3B	NBR
041134	POLO-	DİREKSİYON KUTUSU Steering Box	-	-	12012530	-	19,00	34,60		6,20	9,20	L3BL	NBR
041126	PASSAT-TRANSPORTER T4	DİREKSİYON KUTUSU Steering Box	0770080273	0770198130	01016544	-	20,00	30,00		5,00	6,00	L3BTL	NBR
040820	MINİBUS-KAMYONET SERİSİ ZF 8033 TİP.KUTU	DİREKSİYON KUTUSU Steering Box	N140401	-	12016820	-	20,00	30,00		7,00	8,00	L3BTL	NBR
041251-NL	PASSAT-GOLF-TRW	DİREKSİYON SİSTEMİ Steering System	-	-	12012051	-	23,00	34,43	38,00	3,70	7,50	LL3TL	NBR+TPU
041123-H	BORA-GOLF	DİREKSİYON KUTUSU Steering Box	-	-	01016892	-	24,00	33,00		5,00		L3BTI	HNBR
040878	1500-1600 VARIANT	DİREKSİYON SİSTEMİ Steering System	311415297	-	12010842	-	24,00	37,00		7,00		L3BTL	NBR
041204-H	BORA-GOLF-ZF	DİREKSİYON KUTUSU Steering Box	7891033104	-	01019952	-	24,00	37,00		8,50		L3B	HNBR
041212-NL	OTOMOBİL SERİSİ	DİREKSİYON KUTUSU Steering Box	7891033104	-	01019952	-	24,00	37,00		8,50		L3BTI	NBR+TPU
041203-H	BORA-GOLF-ZF	DİREKSİYON KUTUSU Steering Box	7891033105	-	01016893	-	24,00	39,00		8,50		L3B	HNBR
041122-H	VOLT	DİREKSİYON KUTUSU Steering Box	0770080436	0770198203	01019954	-	25,00	34,00		7,00		L3BT	HNBR
041121-H	TRANSPORTER T4	DİREKSİYON KUTUSU Steering Box	-	-	01018101	-	26,00	37,00		7,00		L3BT	HNBR
041129-H	PASSAT	DİREKSİYON KUTUSU Steering Box	-	-	19019827	-	27,70	38,00		8,50		L3B	HNBR
041118-H	BORA-GOLF-PASSAT (ZF TİP KUTU)	DİREKSİYON KUTUSU Steering Box	0770080425	0770198107	01016891	-	28,00	37,00		5,00		L3BT	HNBR
040786	PASSAT-GOLF-MİNİBÜS SERİSİ	DİREKSİYON SİSTEMİ Steering System	0770080412	-	01016891	-	28,00	37,00		5,00		L3BTL	NBR
041133	PASSAT-TRANSPORTER T4	DİREKSİYON KUTUSU Steering Box	-	-	01015867	-	28,00	38,00		7,00		SPL3B	NBR
040849	1200-1300-1500 SERİ	DİREKSİYON SİSTEMİ Steering System	113415297	-	19015771	164.500	28,00	40,00		6,00		L3BTL	NBR

MOTOR GRUBU / Engine Group

SKT NO	KULLANILAN MODELLER Models	KULLANIM YERİ Place Of Use	ORJINAL NO 1 Original No 1	ORJINAL NO 2 Original No 2	EŞDEĞER NO 1 Equivalent No 1	EŞDEĞER NO 2 Equivalent No 2	ÖLÇÜLER MM. Dimensions - MM.				TİP Type	MALZEME Material
040692-V	340 1.7	KRANK ÖN Crank Shaft Front	3287556	-	12013862	-	25,00	42,00		8,00	L3T SAĞ -Right	FKM
040944-V	960 SERİSİ	KRANK ÖN Crank Shaft Front	5646262	93180737	12018321	069.590	31,00	41,00		7,00	L13TL SAĞ -Right	FKM
041272-FP	V40-V50-V60-V70-S80 D2- 1.6DRIVEE-2.5 TDI	KRANK ÖN Crank Shaft Front	8658642	-	20026413	129.780	32,00	47,00		10,00	F2TL SAĞ -Right	PTFE+ACM
041169-V	V70-V60-V40-C30-S40-S60-740	KRANK ÖN Crank Shaft Front	30711646	31293199	15510081	023.590 81-33869-00	33,00	47,00		5,00	L3TL SAĞ -Right	FKM
040969-V	240 2.0 D, 2.4 D	KRANK ÖN Crank Shaft Front	1257113	-	12010739	294.357 475.961	35,00	48,00		10,00	L3TL SAĞ -Right	FKM
040831-V	66 1.1, 1.3	KRANK ÖN Crank Shaft Front	30874307	-	12011547	293.946	35,00	50,00		8,00	L13TL SAĞ -Right	FKM
046119-FP	V70-V50-V60-S40-S60-C30	KRANK ÖN Crank Shaft Front	30711488	30711489	20029116	026.750	40,00	55,00		6,40	F2TL SAĞ -Right	PTFE+ACM
046007-V	S40-V40-V70 1.9 Dİ	KRANK ÖN Crank Shaft Front	30862838	-	12018755	157.200 981.480	42,00	54,00		6,00	L3TL SAĞ -Right	FKM
046132-P	240 2.8	KRANK ÖN Crank Shaft Front	1218034	-	12013896 12011459	040.355 040.363	42,00	62,00		10,00	L3TL SAĞ -Right	ACM
045776-V	340-440-460-S40-V40 1.9D	KRANK ÖN Crank Shaft Front	8414241	-	12013865 12015902	508.470	50,00	68,00		10,00	L3TL SAĞ -Right	FKM
045964-V	164-340-740-760-240 2.0	KRANK ÖN Crank Shaft Front	1276424	1266605	15012624	141.960 465.194	52,00	68,00		10,00	L13TL SAĞ -Right	FKM
047843-V	66 1.1, 1.3	KRANK ARKA Crank Shaft Rear	3104402	-	16012790	-	70,00	90,00		10,00	L3T SOL -Left	FKM
047475-S	240 2.7-2.8	KRANK ARKA Crank Shaft Rear	1218027	3267244	12014827	20026854	80,00	100,00		13,00	L3 SOL -Left	VMQ
047851-FP	S40-S60-V60-V70-V50	KRANK ARKA Crank Shaft Rear	30711648	31330417 30711648	19036358	023.862 81-90011-00	80,00	182,00		19,40	SPF5L SOL-Left	PTFE+ACM
410276-V	440-460-S40-V40 1.9 D	KRANK ARKA Crank Shaft Rear	1257049	3287542	12012347 20015851	315.494 81-23708-50	85,00	105,00		12,00	L3TL SOL -Left	FKM
410386-V	S40 I / V40 I 1.9 Dİ	KRANK ARKA Crank Shaft Rear	30862835	-	12015424 20018066	508.462 81-23708-50	85,00	105,00		8,00	L3TL SOL -Left	FKM
410397-V	240 2.0 D, 2.4 D	KRANK ARKA Crank Shaft Rear	1257049	-	12012347 20015851	315.494	85,00	105,00		12,00	L13TL SOL -Left	FKM
412349-FK	940 II 2.4 TD	KRANK ARKA Crank Shaft Rear	357Q6701AA / AB	1230864 1684285	20030332 82036539	026.812 026.811	106,00	190,00	196,00	15,20	SPF5L SOL-Left	PTFE+YÜN

MOTOR GRUBU / Engine Group

SKT NO	KULLANILAN MODELLER Models	KULLANIM YERİ Place Of Use	ORJINAL NO 1 Original No 1	ORJINAL NO 2 Original No 2	EŞDEĞER NO 1 Equivalent No 1	EŞDEĞER NO 2 Equivalent No 2	ÖLÇÜLER MM. Dimensions - MM.					TİP Type	MALZEME Material
040699-S	340-360-440-460-480	EKSANTRİK MİLİ-ARKA Cam Shaft-Rear	7703087191	7700742021	20015738	508.608	22,00	45,00		8,00		L3 SOL -Left	VMQ
041168-P	C30-C70-S40-S60-S80-V50-V70	EKSANTRİK MİLİ Cam Shaft	30651791	1367707	12018554	-	27,00	42,00		8,00		L3TL SAĞ -Right	ACM
041151-FP	C40-S40-S80-V50-V70	EKSANTRİK MİLİ Cam Shaft	30735092	31316791	20029115	026.740	27,00	47,00		7,00		F2TL SAĞ -Right	PTFE+ACM
041256-V	C30-C70-S40-S80-V50-V70 2.0 D	EKSANTRİK MİLİ Cam Shaft	8653758	-	20026123	153.740	27,00	47,00		7,00		L3TL SAĞ -Right	FKM
040693-V	V40-S40	EKSANTRİK MİLİ Cam Shaft	8420818	-	12014403	508.489	30,00	40,00		7,00		L3TL SAĞ -Right	FKM
040946-V	240-740-760-940-960 2.0 D, 2.4 D	EKSANTRİK MİLİ Cam Shaft	1257221	-	12012709	325.155 325.156	32,00	47,00		10,00		L3TL SS- RL	FKM
041114-V	240-340-740-760-940-960 2.0	EKSANTRİK MİLİ Cam Shaft	6842273	-	12015674	504.483 336.999	35,00	47,00		6,00		L3TL SAĞ -Right	FKM
040816-V	240-340-740-760-940 2.0	EKSANTRİK MİLİ Cam Shaft	1306333	-	12013859	504.983	35,00	47,00		7,00		L3TL SAĞ -Right	FKM
040740-V	S40 I / V40 I 1.8 B./S.W.	EKSANTRİK MİLİ Cam Shaft	30874307	-	19026017	-	35,00	50,00		8,00		L3TL SAĞ -Right	FKM
040634-S	340-360	EKSANTRİK MİLİ Cam Shaft	3277600	-	12011246	507.806	35,00	50,00		10,00		L3L SAĞ -Right	VMQ
046256-V	C-S-V 40-70-90-850-960 SERİSİ 2.0-2.4-2.5 BENZ. MOT.	EKSANTRİK MİLİ Cam Shaft	6842272	-	15018287	135.180	45,00	57,00		7,00		L3L SAĞ -Right	FKM
046258-VAE	C,S,V 40-60-70-CX SERİSİ 1.6-1.8-2.0-2.4-2.5 BENZ.MOT. EM	EKSANTRİK MİLİ Cam Shaft	9440651	1439886	20026696	362.730	45,00	65,00		7,00		L3TL SAĞ -Right	FKM+AEM
046254-V	C-S-V 40-XC- 1.6-1.8-2.0-2.4-2.5 BENZ. MOT. YM	EKSANTRİK MİLİ Cam Shaft	1371718	9458309	20026695	362.740	45,00	65,00		7,00		L3TL SAĞ -Right	FKM
040922-V	740-850-960-S40-S60-S70- V40-V90-V70 2.0 MOT.	YARDIMCI MİL Auxiliary Shaft	3514943	9443310	15000581	733.620 135.151	30,00	47,00		7,00		L3	FKM
4S-066-V	S40-S60-V40-V60-V70 T2-T3-T4 MOT.	SUPAP Valve Stem Seal	31330403	31370986	82337066 12037066	317.020 70-37728-00	5,00	9,50	22,60	17,00		LSY5T	FKM
4S-048-V	V70-V50-V60-C30- 1.6D	SUPAP Valve Stem Seal	31330184	-	19035539	027.750	5,50	9,50	22,90	14,00	17,50	LSY5T	FKM

MOTOR GRUBU / Engine Group

SKT NO	KULLANILAN MODELLER Models	KULLANIM YERİ Place Of Use	ORJINAL NO 1 Original No 1	ORJINAL NO 1 Original No 2	EŞDEĞER NO 1 Equivalent No 1	EŞDEĞER NO 1 Equivalent No 2	ÖLÇÜLER MM. Dimensions - MM.					TİP Type	MALZEME Material
4S-045-V	C30 D5 B	SUPAP Valve Stem Seal	8631652	-	12016586	069.630 70-33512-00	6,00	8,80	11,70	9,50		LSY2T	FKM
4S-068-V	C30-C70-S40-V50-V70 2.0 JTD DW10	SUPAP Valve Stem Seal	8653750	-	12016913	136.940	6,00	10,00	19,60	21,50		LSY5T	FKM
4S-033-V	740 2.0	SUPAP Valve Stem Seal	30638662	30889394	12014582	701.289 70-26058-00	7,00	9,80	13,20	9,00		LSY2T	FKM
4S-021-V	240 2.8	SUPAP Valve Stem Seal	1218173	1257052	12014584 49472013	553.190	8,00	10,80	14,20	10,00		LSY2T	FKM
4S-022-V	S80 II 4.4 V8 B	SUPAP-EKSOZ Exhaust Valve	30720175	-	19027766	49472839	5,50	11,00		6,00	10,00	LSYT	FKM
040765-V	340 1.7	YAĞ POMPASI Oil Pump	8420818	-	12014403	-	30,00	40,00		7,00		L3L	FKM
041274-P	C30-S40-S80-V50-V70 DV6 MOT.	ENJEKTÖR GÖVDE KEÇESİ Injector Body Seal	3M5Q9R524AA	1233683	734.960	-	18,00	29,00		6,00		L2T	ACM

AKS GRUBU / Axle Group

SKT NO	KULLANILAN MODELLER Models	KULLANIM YERİ Place Of Use	ORJINAL NO 1 Original No 1	ORJINAL NO 1 Original No 2	EŞDEĞER NO 1 Equivalent No 1	EŞDEĞER NO 1 Equivalent No 2	ÖLÇÜLER MM. Dimensions - MM.					TİP Type	MALZEME Material
046139	66 1.1, 1.3	ÖN AKS Front Axle	3104014	-	12013698	01031057	38,00	52,00		7,00		L3L	NBR
045688	66 1.1, 1.3	ARKA AKS Rear Axle	3102798	3296234	12013759	040.673	45,00	62,00		7,00	8,00	L3L	NBR

DİFERANSİYEL GRUBU / Differential Group

SKT NO	KULLANILAN MODELLER Models	KULLANIM YERİ Place Of Use	ORJINAL NO 1 Original No 1	ORJINAL NO 1 Original No 2	EŞDEĞER NO 1 Equivalent No 1	EŞDEĞER NO 1 Equivalent No 2	ÖLÇÜLER MM. Dimensions - MM.					TİP Type	MALZEME Material
046259-P	S40-V43	DİFERANSİYEL SAĞ ÇIKIŞ Dif.-Right Output	30819932	-	01029132	050.560	27,95	56,00		7,00		L3TL SAĞ -Right	ACM
041058-V	C30-S40-S80-V50-V70	DİFERANSİYEL SAĞ ÇIKIŞ Dif.-Right Output	9143885	1207619	01034061	562.653	28,00	38,00		7,00		L3TL SAĞ -Right	FKM
046001-P	740-760-S60-S70-'940-V SERİSİ 2.0	DİFERANSİYEL SAĞ-SOL ÇIKIŞ Dif.-Right/Left Output	1377058	8653928	01034063	-	35,00	55,00		9,00	15,50	L3LR SS- RL	ACM

ŞANZİMAN GRUBU / Gearbox Group

SKT NO	KULLANILAN MODELLER Models	KULLANIM YERİ Place Of Use	ORJINAL NO 1 Original No 1	ORJINAL NO 1 Original No 2	EŞDEĞER NO 1 Equivalent No 1	EŞDEĞER NO 1 Equivalent No 2	ÖLÇÜLER MM. Dimensions - MM.					TİP Type	MALZEME Material
040588-P	S40 I / V40 I 1.8 B./S.W.	ŞANZİMAN ÖN Gearbox Front	30874170	-	19027874	247.260	25,00	35,00		6,00		L3L SAĞ -Right	ACM
041306-P	S40 1.8I	ŞANZİMAN ÖN Gearbox Front	30874170	-	19027874	247.260	25,00	35,00		6,00		SPL3L SAĞ-Right	ACM
040755-P	940 2.0	ŞANZİMAN ÖN Gearbox Front	6843480	-	01034098	-	28,00	40,00		9,00		L3TL SAĞ -Right	ACM
045902-P	C30-S40-V50	ŞANZİMAN ARKA Gearbox Rear	30713022	-	12019597	-	40,00	55,00		8,00		L13L SS-RL	ACM
045226-V	850 2.0	ŞANZİMAN ARKA Gearbox Rear	6843481	-	01034065	-	40,00	60,00		10,00		L3L	FKM
040573	740 2.3	VİTES SEÇİCİ MİLİ Gear Selection Shaft	1339707	-	01033982	875.750	10,00	18,00		5,00		L3	NBR
040426	240 2.0	VİTES SEÇİCİ MİLİ Gear Selection Shaft	947705	-	01019151	-	15,00	21,00		5,00	7,00	L1L	NBR

DİREKSİYON GRUBU / Steering Group

SKT NO	KULLANILAN MODELLER Models	KULLANIM YERİ Place Of Use	ORJINAL NO 1 Original No 1	ORJINAL NO 1 Original No 2	EŞDEĞER NO 1 Equivalent No 1	EŞDEĞER NO 1 Equivalent No 2	ÖLÇÜLER MM. Dimensions - MM.					TİP Type	MALZEME Material
041137	C70	DİREKSİYON MİLİ Steering Shaft	74164399	-	12014253	-	14,60	35,00		4,90		L2	NBR
041134	C70-850	DİREKSİYON MİLİ Steering Shaft	-	-	12012530	-	19,00	34,60		6,20	9,20	L3BL	NBR
041202-H	S40-S60	DİREKSİYON KUTUSU Steering Box	-	-	19020602	-	24,00	36,50		8,50		L3B	NBR
041125	C70	DİREKSİYON KUTUSU Steering Box	-	-	12000626	-	24.97	37,54	41,24	4,20	7,40	SPL3B	NBR
040845	PV 444/445/1200/1800	DİREKSİYON KUTUSU Steering Box	-	-	01033710	-	25,00	36,00		6,00		L3BTL	NBR
041251-NL	C70	DİREKSİYON KUTUSU Steering Box	-	-	294.110	-	23,30	29,70		4,00		L2	NBR+TPU







SKT Yedek Parça ve Makina Sanayi ve Ticaret A.Ş.
BOSB, Ali Osman Sönmez Bulvarı No: 17 16140 Nilüfer/Bursa-TÜRKİYE
T:+9 0 224 243 41 00 info@skt.com.tr



TecAlliance
Certified Data Supplier