



# **TRAKTÖR & İŞ MAKİNESİ KATALOĞU**

**Agriculture & Construction Machines Catalogue**

**2023**

Sektöründe,  
müşteri ilişkilerini güven ve  
memnuniyet temeli üzerine kurmuş olan SKT,  
sızdırmazlık ürünleri konusunda doğru ve güvenilir çözümler  
sunmaya devam etmektedir.

Yenilikçi ve mükemmeliyetçi gelecek vizyonu ile sektöründe zirvenin en güçlü  
oyuncularından biri olmayı başaran SKT, ürün gamına kattığı ürün çeşitleri iş ortaklarına her  
zamanki gibi üstün kalitede ürünler sunmayı amaçlamıştır.

SKT'nin ürün bilgilerine **TECDOC** katalog sisteminden ulaşabilirsiniz.

SKT, bu yıl da müşterilerine kaliteli ürünler sunarak, müşteri odaklı hizmet ve hızlı ve güvenilir teslimat  
prensipleriyle yoluna emin adımlarla devam edecektir.

Ailemizin bir parçası olan tüm değerli iş ortaklarımıza teşekkür ederiz.

---

Having established its customer relations based on trust and satisfaction, SKT  
continues to offer proper and reliable solutions for sealing products.

With its innovative and perfectionist vision of the future, SKT has managed to become one of the strongest  
players in the sector and aims to offer its business partners high-quality products.

SKT is a certified data supplier of TecAlliance.  
SKT's product portfolio is available at **TecDoc**.

SKT will continue on its way with firm steps by offering its customers high-quality  
products also in this year with the principle of customer-oriented  
services and fast and reliable deliveries.

We would like to thank all our valuable business partners who have been  
a part of our family.

**TRAKTÖR & İŞ MAKİNESİ**  
**KATALOĐU**

Agriculture & Construction Machines Catalogue

[www.skt.com.tr](http://www.skt.com.tr)

**BİZİ TAKİP EDİN / Follow us**



sktoilsealingtechnologies

**Bu katalog önceki tüm sayıların yerini almaktadır. Bu katalog telif hakları ile korunmaktadır.  
Bu kataloğun tamamının veya herhangi bir bölümünün çoğaltılması yasaktır.**

**Bu katalogdaki motor veya araç üreticilerinin tüm orijinal parça numaraları sadece karşılaştırma amacıyla verilmiştir ve araç sahipleri ile temaslarda kullanılmamalıdır. Bu katalogdaki bilgilerin basım anında doğru olması için her türlü çaba gösterilmiştir, ancak SKT herhangi bir sorumluluk kabul edemez. Oluşabilecek hatalar için bileşenlerimizi gerektiği gibi değiştirme hakkımız saklıdır. Orijinal ekipman parça numaraları ve katalogda belirtilen eşdeğer numaralar, yalnızca SKT numaralarıyla çapraz referans karşılaştırması işlevi görür. Herhangi bir tavsiye notunda veya faturada görünmemelidirler.**

This catalog replaces all previous editions. The catalog is protected by copyright.  
Reproduction of this or any part of it is prohibited.

All original part numbers of engine or vehicle manufacturers in this catalog are provided for comparison purposes only and should not be used in contacts with vehicle owners. Every effort has been made to ensure that the information in this catalog is correct at the time of printing, but SKT cannot accept any liability. We reserve the right to change our components as necessary for any errors that may occur. Original equipment part numbers and equivalent numbers listed in the catalog serve only as a cross-reference comparison with SKT numbers. They should not appear on any referral notes or invoices.

**Malzeme Bilgileri / Material Information**

**Tip Açıklamaları / Type Description Page**

**Tip Tanıtım Sayfaları / Type Description Page**

**Keçe Tiplerinde Kullanılan Harf Kodlarının Açıklamaları**  
Explanation Of Letter Codes Used In Seal Types

**Keçe Ölçülendirme Sistemi**  
Seal Dimensioning System

**Yağ Keçesi Genel Montaj Kuralları**  
Oil Seal Installation Guide

**Traktor & İş Makinesi Kataloğu**  
Agriculture & Construction Machines Catalogue

**CARRARO**

**CASE**

**CLAAS**

**CLAYSON Biçerdöver (Combine Harvester)**

**DANA Transmisyon (Drivetrain Sys.)**

**DEUTZ - FAHR**

**ERKUNT**

**FENDT**

**FORD**

**GOLDONI**

**GRAZIANO**

**HATTAT**

**HİDROMEK**

6	IHC-INTERNATIONAL	51
7	JCB	52
8	JOHN DEERE	54
10	LAMBORGHINI	58
	LANDINI	60
11	LAVERDA	63
	LEYLAND	64
12	MASSEY FERGUSON	65
	NEW HOLLAND - FIAT	73
	PERKINS Motor / Engine	86
16	RENAULT	87
24	SAME	88
27	STEYR - BAŞAK	92
29	TÜMOSAN	96
31	VALTRA	100
33	DİĞER MARKALAR - Other Brands	
34	CATERPILLAR - CHAMPION	101
36	EDER - FERMEC - TEREX - KOMATSU - LOMBARDINI - MANITOU	102
38	MERLO - PANCAR MOTOR	103
41	SHIBAURA - SÜPER STAR	104
43	UNIVERSAL UTB - ZETOR	105
44		
50		

İÇİNDEKİLER

# MALZEME BİLGİLERİ / Material Information

Malzeme Adı Material	SKT Kodu SKT Code	Kısa Kodu Abbreviation	Çalışma Sıcaklığı Operating Temp.	AÇIKLAMA	DESCRIPTION
Nitril Kauçuk Nitrile Rubber	-N	NBR	-40 / 105	Genel olarak fiyat / fonksiyon dengesi yüzünden tercih edilen ve düşük sıcaklıklarda kullanılabilen yağ ve greslere dayanıklı genel amaçlı bir keçe malzemesidir. Glikol esaslı fren yağları ve EP katkılı yağlara direnci zayıftır. Yakıtlar ve sanayi sıvıları için özel geliştirilmiş karışımları vardır. Otomotiv sektöründe aks keçelerinde büyük bir kullanıma sahiptir.	It is an economical and general purpose sealing material and preferred due to being resistant against low temperature oil and grease. It has poor resistance to glycol based brake oils and oils with EP additives. There are specially developed mixtures of this material for fuels and industrial fluids. It has a great use in axle seals in the automotive industry.
Hidrojenenitril Kauçuk Hydrogenated Nitrile Rubber	-H	HNBR	-70 / 150	Genel olarak Nitril kauçuk özelliklerini taşır. Nitril kauçuğa ilave olarak esneklik, hava direnci ve ozona dayanım gibi yüksek mekanik özelliklere de sahiptir. Yüksek mekanik dayanım gerektiren direksiyon sistemi ve aks gibi yerlerde kullanım alanı vardır.	This rubber has similar characteristics to nitrile rubber, but it additionally has the mechanical features such as more flexibility, higher weather and ozone- resistance. It is used in applications where high mechanical strength is required such as steering systems, axles and so on.
Florokarbon Kauçuk Fluorocarbon Rubber	-V	FKM	-30 / 220	Sıcaklığın ve yüksek devirin olduğu ortamlarda kullanılan bir kauçuktur. Gres, yakıt, yağ, çözücüler ve kimyasal maddelerin bir çoğuna dayanıklıdır. Fiyat yönünden pahalı bir malzeme olmasına karşın otomotiv sektöründe motor, şanzıman, diferansiyel gibi alanlar ile endüstriyel alanda uzun süre dayanım istenen makinalarda tercih edilir.	This rubber is used in high temperature and high rpm conditions. It is resistant to many types of grease, fuel, oil, solvent and chemicals. Despite being relatively expensive- compared to the other types of rubber materials, this material is employed in fields such as engine, gearbox, differential in automotive industry and also in industrial machines when long-term durability is needed.
Poliakrilik Acrylic Rubber	-P	ACM	-30 / 150	EP katkılı yağlara ve ozona dayanıklı bir malzemedir. Yakıt ve düşük sıcaklık dayanımı zayıf bir malzemedir. Otomotiv sektöründe özellikle şanzıman ve diferansiyel keçelerinde yoğun olarak kullanılır.	This rubber has good resistance to oils with EP additives and ozone. Resistance to fuel and low temperature of this material is somewhat inferior. It is used in gearbox and differential seals in automotive sector.
Silikon Kauçuk Silicone Rubber	-S	VMQ	-60 / 225	Çok iyi bir motor keçesi malzemesidir. Esneklik, hava direnci ve ozona dayanımı yüksektir. Ancak haSS-RLas bir malzeme olduğu için kolayca yırtılabilir, deforme olabilir. Bu nedenle yüksek mekanik dayanım gerektiren ortamlarda ve yakıtlarda EP katkılı yağlarda kullanılması önerilmez.	This rubber is an excellent material for engine seals. In addition to flexibility, its weather and ozone resistance is very high. Yet, it is prone to wear-tear and deformation due to being a very sensitive material. Therefore, it is not recommended in conditions where oils with EP additives are used and high mechanical strength is required.
Etilen Propilen Kauçuk Ethylene-Propylene Rubber	-E	EPDM	-60 / 150	Glikol esaslı fren yağları, ozona, su buharına, fosfat ester akışkanlara direnci iyidir. Yakıtlarda ve petrol esaslı yağlara direnci düşüktür.	This rubber has good resistance to glycol based brake oils, ozone, water vapor, phosphate ester fluids whereas it has low resistance to fuels and petroleum based oils.
Stiren Butadien Kauçuk Styrene-Butadiene Rubber	-R	SBR	-50 / 100	Glikol esaslı fren yağları, asit ve bazlara alkole direnci iyidir. Genel olarak araçların fren sistemlerinde kullanılır. Yakıtlarda ve petrol esaslı yağlara direnci düşüktür.	This rubber has good resistance to glycol based brake oils, acids and bases. It is generally used in brake systems of vehicles. It has low resistance to fuels and petroleum based oils.
Tabii Kauçuk Natural Rubber	-T	NR	-60 / 90	Stiren Butadien kauçuk ile benzer özellikler gösterir. Araçların süspansiyon sistemleri gibi ozona direnç , yüksek esneklik ve mekanik dayanım gerektiren yerlerde kullanılır.	This rubber has similar features to styrene-butadiene rubber. It is used in areas like vehicle suspension systems where ozone resistance, high flexibility and high strength is required.
Politetrafloroetilen Polytetrafluoroethylene	-F	PTFE	-260 / 260	Bilinen tüm kimyasallara dayanıklı bir plastik malzemedir. Sürtünme katsayısı en düşük katı bir maddedir. Yapışma özelliği göstermeyen yağlamasız bir yatak malzemesidir. Uygulama alanına göre dolgu yapısı değiştirilebilir. Son yıllarda çok tercih edilen bir motor keçe malzemesidir.	This is a material which is resistant to all known chemicals. It has the lowest coefficient of friction of any solid material. It is a non-adhesive bearing material without lubrication. Filling composition of PTFE may change depending on the field of use. This material is highly preferred in engine seals recently.
Poliamid Polyamide	-C	PA	-20 / 90	Piyasa da "Naylon" olarak bilinir. Sürtünme ve aşınma gibi mekanik özellikleri iyidir. Yağlara, yakıtlara, esterlere, ketonlara karşı dirençlidir.	Also known as nylon, this material has high friction, wear resistance and good mechanical features. It is also resistant to oils, fuels, esters and ketones.
Termoplastik Poliüretan Thermoplastic Polyurethane	-L	TPU	-40 / 90	Özellikle esneklik, aşınma ve sürtünme gibi yüksek mekanik özelliklerine sahip bu malzeme yağlara, greslere ve birçok çözücüye göre dirençlidir. Kullanım yeri kirliliği ve aşındırıcıların yoğun olduğu ortamlarda kullanılan kombi keçelerin yağ dudaklarını koruyucu malzeme olarak kullanılır. Çit-gel harekete sahip ortamlarda da sızdırmazlık malzemesi olarak kullanılır.	In addition to good mechanical features such as high flexibility, high wear and friction durability, this rubber is resistant to oils, greases and many solvents. It is used as a protective material in sealing lips of combi seals which are employed in areas that contains highly dirty and abrasive particles. It is used as sealing material where back and forth axial movement is performed.
Etilen Akriklik Kauçuk Ethylene Acrylic Rubber	-AE	AEM	-30 / 150	Yüksek ısı ve ozon direncine sahip olan AEM kauçuk , motor yağları, şanzıman sıvıları, asidik kondensatlar, üre çözeltileri, soğutucu sıvılar ve gresler gibi sıvılara dayanır. Düşük sıcaklıkta esnekliği, yüksek çekme dayanımı özellikleri ile elektrikli ve hibrit araç bileşenleri dahil olmak üzere zorlu otomotiv uygulamalarında çalışan sızdırmazlık elemanları ve grometlerin üretiminde kullanılır.	AEM rubber which has high heat and ozone resistance, withstands fluids such as engine oils, transmiSS-RLion fluids, acidic condensates, urea solutions, coolants and greases. With its low temperature flexibility, high tensile strength properties, it is used in the manufacture of seals and grommets that work in demanding automotive applications, including electric and hybrid vehicle components.

# TİP AÇIKLAMALARI / Type Descriptions

Profil Tipleri / Profile Type			AÇIKLAMA	DESCRIPTION
 L3	 L3L	 L3TL	Dış çapları kauçuk kaplıdır. Bazı tiplerinde montaj kolaylığı ve yuvadaki deformasyon kaynaklı sızırmalara karşı dış çaplarında tırtıl vardır. Ayrıca bazı tiplerinde de kirliliği ortamlarda koruyuculuk sağlayan toz dudak ilave edilmiştir. Isıl genleşme katsayısı yüksek, parçalı, yüzey pürüzlülüğü yüksek ve eksenli kaçık yuvalarda da kullanılabilirler.	Outer surfaces are rubber coated. Some types also have grooves on the Outer layer in order to ease installation process and to act against leakages caused by the deformities in the housing bore. Furthermore, some types have dust lip for preventing dirt ingestion. They can be used in spaces consisting of materials with high coefficient of expansion and in divided spaces with a centre offset.
 L1	 L1L		Dış çapları metal kaplıdır. Yuvalarına sıkı geçerler. Isıl genleşme katsayıları yüksek metal (alüminyum gibi) yuvalarda ve parçalı yuvalarda kullanılması önerilmez. Bazı tiplerinde kirliliği ortamlar için koruyuculuk sağlayan kullanılan toz dudak ilave edilmiştir.	Outer surfaces are metallic. These seals are in interference fitting contact with the housing. Use of these types are not recommended in spaces with high coefficient of expansion (e.g. aluminium) and in divided spaces with a centre offset. Some types also have the secondary dust lip to exclude contaminants.
 L13	 L13L		Genel olarak L3 ve L1 kombinasyonuna sahip keçe tipleridir. Dış çaptaki sac bölge merkezleme ve sıklığı sağlarken kauçuk bölge ise yuvadaki sızdırmazlığı sağlar. Isıl genleşmelerden az etkilenen modern bir dış tasarıma sahiptirler.	In general, these seal types are a combination of types L1 and L3. On the Outer diameter, metallic surface helps in centering while rubber surface provides sealing in the housing. They have a modern design that is affected less by thermal expansion.
 SL	 SLL		L1 keçe tiplerinin tüm özelliklerini taşımalarının yanında büyük çaplarda montaj kolaylığı sağlarlar. Yapısal olarak montaj hatalarına karşı daha dirençlidirler. İç taraftaki bilezik keçeye büyük bir mukavemet sağlarken rulmanlardan gelen yağ jetlerini de karşılayarak keçe dudacağının sağlıklı çalışmasını sağlarlar.	In addition to all features of type L1, these seals offer ease of assembly in large diameters. They are also quite resistant structurally against assembly errors. Inner ring enhances the structural strength of the seal, while also acts as a shield against oil jets to help sealing lip to function healthily.
 L3 B	 L3BL	 L3BTL	Standart yağ keçeleri 0,5 bar'a kadar çalışabilir. Bu tip keçeler daha yüksek basınçta çalışabilmesi için sac ve dudak profili özel tasarlanmıştır. Bu tip keçelerin verimli çalışabilmesi için ortam şartları, keçenin profili, dudak malzemesi, mil çapı ve devir sayısı önemlidir. Bu keçeler tasarıma da bağlı olmak üzere 5 bar'a kadar çalışabilirler.	Standard oil seals can operate at pressures up to 0,5 bar. Steel case and lip seal profiles of these seals, however, are designed specially in order to obtain the desired resistance against higher pressure values. In order these types of seals to run efficiently ambient conditions, design of the lip seal profile, lip material, shaft diameter and the rpm parameters are significant. Depending on the design, these seals can operate at pressures up to 5 bar.
 L2	 L5		Bu tip keçeler genel olarak gres ve yağ buharı ve tozlu ortamlar için kullanılır. Yay kullanılmadığı için sıvı sızdırmazlığına karşı kullanılmazlar. Bazı uygulamalarda mil kazıyıcı olarak da kullanılabilirler.	These types of seals are mainly used for sealing grease, lubricant steam and dust. Since there is no garter spring, they cannot be used for fluid sealing. In some applications, they can be employed as shaft wipers as well.
 SC4	 SC6		Birbirine bağlı olarak çalışan hareketli iki parçadan meydana gelirler. Dış taraf yuvaya, iç taraf ta mile sıkı geçerek çalışırlar ve sızdırmazlık mekanizması iki parça arasında garter yayına sahip sızdırmaz dudak ile kurulmuştur. Standart keçelere göre çok daha yüksek koruyuculuk sağlarlar. Genel olarak yüksek kirlilik ve yük altında çalışan traktör ve ağır vasıtaların akslarında kullanılırlar.	Cassette seals consist of two moving parts that operate in conjunction with each other. Outer ring is in interference fitting contact with the housing and the inner ring with the shaft, while the sealing mechanism is established with main lip with a garter spring in between these rings. Cassette seals are highly rigid and protective and therefore used for very heavy-duty and in dirty environments, like commercial vehicles, tractors and agricultural machinery.
 KOMBI 1X	 KOMBI 2X	 KOMBI 3	Kombi keçeler yüksek koruyuculuğa ihtiyaç duyulan aşırı kirliliği ve aşındırıcı maddeler bulunan ortamlar için tasarlanmış keçe tipleridir. Genelde çift yaylı bir kauçuk sızdırmaz dudaklar ve aşınmaya dayanıklı plastik bir parça ile kombine çalışırlar. Özellikle aşırı kirliliği ortamlarda çalışan traktör aksları ve mekanik dayanım gerektiren direksiyon sistemlerinde kullanılırlar.	Combi seals are designed for extreme wear applications that require high resistance. Generally, two sealing lips with garter spring and an additional wear-resistant plastic part are operating together under the roof of one metal case. They are employed in tractor axles that work under extremely dirty conditions and in steering systems that require mechanical strength.
 F2TK	 F25TL	 F5F	Sürtünme katsayılarının düşük olması nedeniyle son yıllarda sıkça kullanılan PTFE malzemeden üretilmiş motor keçesi tipleridir. Kullanıldığı motorlara düşük emisyon ve minimum güç kaybı avantajı sağlarlar. Standart keçelere göre dış çapları aynı özellikleri taşırlar ancak sızdırmaz dudaklar mile daha geniş bir noktada temas ederler ve mil kalitesi ve montaj yönünden daha hassas çalışan keçe tipleridir. Bazı tiplerinde toz dudak olarak non-woven malzeme kullanılır.	Due to low coefficient of friction they have, these seals are being used as engine seals more often in the recent years. The advantage of them are low emission and low power loss that they provide. Outer surfaces have the same features, however main sealing lips have bigger contact area in comparison to standard seals. Therefore shaft surface quality and installation accuracy plays a big role in sealing performance. Some types have a dust lip of non-woven material.
 ETS	 ETS	 ETS	Yeni nesil motorların daha verimli enerji kullanımı ve düşük emisyon değerleri beklenmektedir. Bu ETS tip keçeler düşük sürtünme, uzun ömür ve yüksek performans sağlayan yapısı sayesinde bu motorlarda rahatça kullanılabilir. Yayı ve mile çok noktadan temas eden bir dudak yapısına sahiptirler. Yeni nesil düşük viskoziteli motor ve şanzıman yağları ile beraber yüksek performansta çalışırlar.	New generation engines are expected to offer more energy efficiency and low emission values. These ETS type seals are great fit for these engines since they provide features such as low friction, long service life and high performance. These seals are spring-less and in contact with the shaft at many points. They operate at high performance with new generation low viscosity engine and transmission oils.

# TİP TANITIM SAYFALARI / Type Description Pages



L1

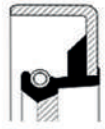

L1 SAĞ

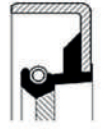

L1 SOL



L1B



L1BL

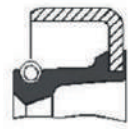

L1C

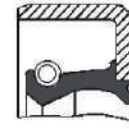

L1L

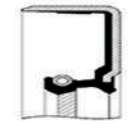

L1L SAĞ



L1L SOL

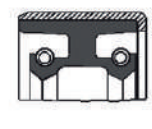

L1X

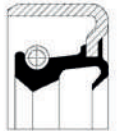

LL1



L2



L2B



L2T



L2TL



L3



L3 SAĞ



L3 SOL

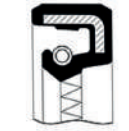

L3 SS



L3B



L3BL



L3BT



L3BTL



L3L



L3L SAĞ



L3L SOL



L3L SS



L3LL



L3T



L3TL



L3TL SAĞ

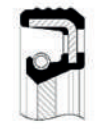

L3TL SOL



L3TL SS



L3TLL

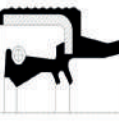

L3TLR SAĞ



LL3TL



LL3TL SOL

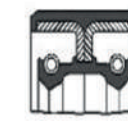

L3X



L3XT SAĞ



L4



L5



L5L



L6 SOL



L6L



L12



L12L



L13BL



L13L SAĞ

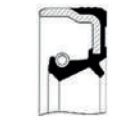

L13TL



L13TL SAĞ

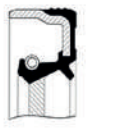

L13TL SOL



L13TL SS

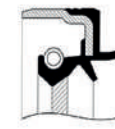

L13TLR SAĞ



L13X



LL13 SOL



F25TL SOL



F2TL SAĞ



SL



SLL

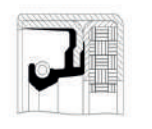

SL1K



## TİP TANITIM SAYFALARI / Type Description Pages

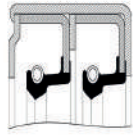

SL1L1



SL1L5

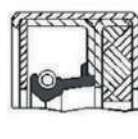

SLK

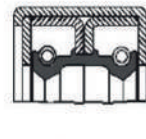

SLX



KOMBI 1X



KOMBI 2X



KOMBI 3

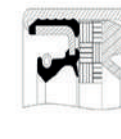

KOMBI 4

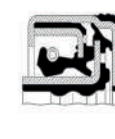

SC4



SC6



SC7



SCF8 SAĞ

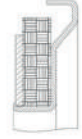

SK2



CSPSK



CL2L



CL3



CL3L



CSL

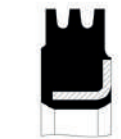

CSPL5L

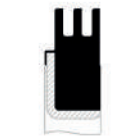

CSPL8L

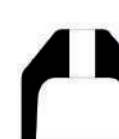

LA1

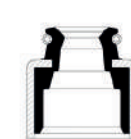

LSY



LSY2T



LSY3



LSY5T

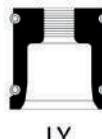

LY



T3T



U3L



UCL



UIL



PI3L

## KEÇE DUDAK BÖLGESİNDEKİ TIRTILLARIN AÇIKLAMASI / Terminology For Sealing Aids

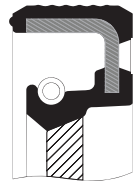

**L3 SAĞ**  
**L3 RIGHT**

**SAĞ DÖNÜŞLÜ MİLLER İÇİN**  
Right-Hand Twist



**L3 SOL**  
**L3 LEFT**

**SOLA DÖNÜŞLÜ MİLLER İÇİN**  
Left-Hand Twist



**L3 SS**  
**L3 RL**

**SAĞ VE SOLA DÖNÜŞLÜ MİLLER İÇİN**  
Alternate Twist

# KEÇE TİPLERİNDE KULLANILAN HARF KODLARININ AÇIKLAMASI

## Explanation Of Letter Codes Used In Seal Types

Sembol / Symbol	Açıklama	Örnek Kullanım / Exemplary Usage	Symbol	Description	Usage example
B	Basınca dayanıklıdır.	L3B	B	Pressure resistant.	L3B
C	Dudak keçe yüksekliğinden daha yüksektir. (1)	L3C	C	Lip height is higher than the seal height.	L3C
C	Keçe dıştan dudaklı ve çevreden çalışmaktadır. (2)	CL3	C	Seal with outside lip, works from periphery.	CL3
ETS	Düşük sürtünmeli ( Yaysız ) dudak yapısına sahiptir.	SC ETS	ETS	Seal without spring, low friction lip structure.	SC ETS
F	PTFE malzeme kullanılmıştır.	SP F	F	PTFE material is used.	SP F
K	Yün malzeme kullanılmıştır. (Non Woven-NW)	F2TK - NW	K	Wool material is used. (Non Woven-NW)	F2TK
L	Kauçuk malzeme kullanılmıştır.	L1, L3	L	Rubber material is used.	L1, L3
L	Toz dudaklıdır. (3)	L3L, L1L	L	With dust lip.	L3L, L1L
LL	Toz dudağı iki tanedir.	L3LL	LL	With two dust lips.	L3LL
R	Alından çalışan bir dudağa sahiptir.	L3R	R	With sealing lip on the front face.	L3R
T	Keçe dış yüzeyi tırtıllıdır.	L3TL	T	Outer surface grooved.	L3TL
SAĞ	Sağa dönen miller içindir.	L3L SAĞ - L3L RIGHT	RIGHT	For right-hand rotating shafts.	L3L RIGHT
SOL	Sola dönen miller içindir.	L3L SOL - L3L LEFT	LEFT	For left-hand rotating shafts.	L3L LEFT
SS	Her iki yöne de çalışan tırtıl yapısına sahiptir.	L3L SS - L3L RL	RL	For bi-directional shafts.	L3L - RL
SC	Kaset tipi keçedir.	SC1	SC	Cassette type seal.	SC1
SP	Standart tiplerden farklı olup, Özel tip tasarıma sahiptir. (Spesiyal) (4)	SPL3	SP	Special design, different from standard types.	SPL3
X	Çift yay ve çift yağ dudağa sahiptir.	L3X	X	With two lips and two springs.	L3X

(1) : Eğer tip tanımının sonunda ise

(2) : Eğer tip tanımının başında ise

(3) : Başa yazılırsa dudak içe doğru sona yazılırsa dudak dışa doğrudur.

(4) : Profil şekli konusunda dikkatli olunmalıdır.

Özel tasarıma sahip olan keçelerde detaylı bilgi için SKT'ye başvurulmalıdır.

(1) : If it is at the end of type definition

(2) : If it is at the beginning of type definition

(3) : Has an inward lip if it is at the beginning; has an outward lip if it is at the end.

(4) : Profile geometry is to be taken into account carefully.

For detailed information on shaft seals with special design, please consult SKT.

# KEÇE ÖLÇÜLENDİRME SİSTEMİ / Seal Dimensioning System

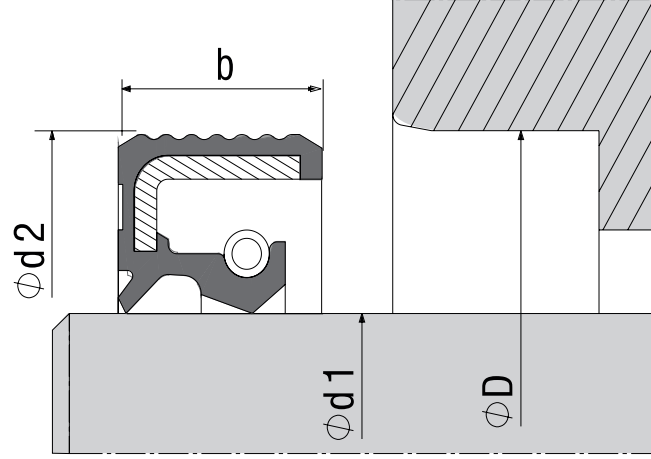

d1	Mil Çapı
D	Yuva Çapı
b	Keçe Yüksekliği
d2	Keçe Dış Çapı

d1	Shaft Diameter
D	Housing Diameter
b	Seal Height
d2	Seal Outer Diameter

Metrik Keçelerin Ölçülendirilmesi Dimensioning of metric seals	d1	x	D	x	b	İnç Ölçülü Keçelerin Ölçülendirilmesi Seal Dimensioning (inches)	d1	x	d2	x	b
	30	x	45	x	8		76,20	x	101,85	x	11,90
	Keçenin çalıştığı mil çapıdır. (Shaft diameter.)		Keçenin çalıştığı yuva çapıdır. (Housing diameter.)		Keçenin toplam yüksekliğidir. (Seal height.)		Keçenin çalıştığı mil çapıdır. (Shaft diameter.)		Keçenin dış çapıdır. Yuva çapı daha küçük olmalıdır. (Seal Outer diameter. Housing diameter has to be smaller.)		Keçenin toplam yüksekliğidir. (Seal height.)

Metrik ölçülü keçelerde D ölçüsü, keçenin çalışacağı yuva çapıdır. Keçe dış çapı bu yuvada yeterli sıklığı sağlayacak şekilde büyük üretilmiştir.

In metric system, dimension "D" is the housing bore diameter. Seal Outer diameter is specified accordingly to provide the required interference.

Inch ölçülü keçelerde, d2 ölçüsü keçenin dış çapıdır. Yuva çapı, keçe dış çapından gerekli sıklığı sağlayacak kadar küçük olmalıdır.

In imperial system, dimension "d2" is the seal Outer diameter. Housing bore diameter has to be less than seal Outer diameter to provide the required interference.

# YAĞ KEÇESİ GENEL MONTAJ KURALLARI

## A. KAÜÇUK DUDAKLI KEÇELER

1. Mil ve yuva; ölçüsel tolerans standartlarına uygun - hasarsız ve temiz olmalıdır.
2. Kauçuk malzemeli keçelerin dudakları montajdan önce ortam yağı ile yağlanmalıdır.
3. Keçe montajında uygun bir aparat kullanılmalıdır, kesinlikle çekiç kullanılmamalıdır.
4. Yay boyları kısaltılmamalıdır. Kısaltılırsa; aşırı sürtünmeden dolayı dudak ve mil hızlı bir şekilde aşınır.
5. Keçe dudağındaki sağ-sol helisel dönüş yönüne dikkat edilmelidir.
6. Kaset ve ABS tipli keçeler yapısal olarak çok hassas bir çalışma sistemine sahip olduğu için montaj sırasında keçenin metal kısmı üzerinde hasar bırakacak darbelerden kaçınılmalı ve aparat kullanılmalıdır.
7. Montajdan sonra keçenin salgısı kontrol edilmelidir.
8. Yuva çok bozuk değilse sıvı conta kesinlikle kullanılmamalıdır.

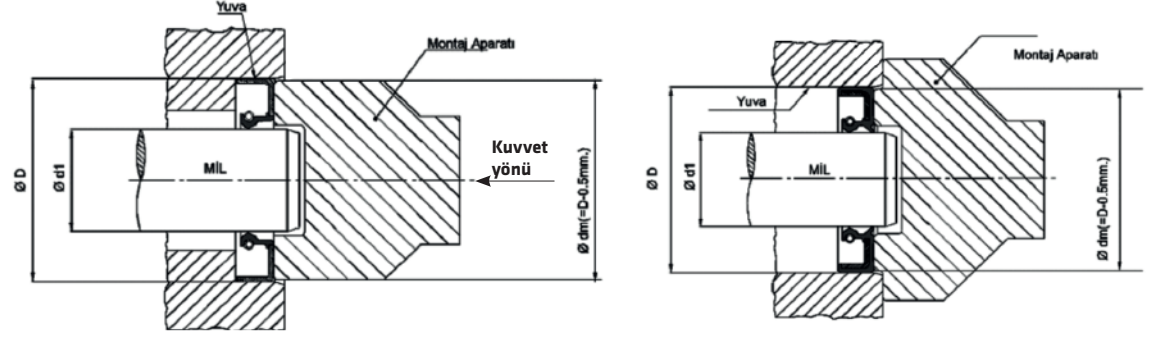

## B. PTFE DUDAKLI KEÇELER

1. PTFE malzemeler mekanik olarak dayanımları zayıf olduğundan kesinlikle hasar görmemeli, mil yüzeyi uygun olmalıdır. PTFE dudağa kesinlikle el ile dokunulmamalı, metal bir madde değmemelidir.
2. Uygun bir aparat yardımı ile montaj yapılmalı çekiç kullanılmamalıdır.
3. PTFE keçeler, keçe üzerinde gelen plastik бага ile birlikte yuvaya yerleştirilmeli ve montaj işlemi bitince plastik бага yerinden çıkarılmalıdır.
4. PTFE malzemeli keçelerin dudakları kesinlikle yağlanmamalıdır. PTFE malzemesinin sürtünme katsayısı çok düşük olduğu için kuru çalışabilme özelliğine sahiptir. PTFE keçenin dudakları yağlanır ise ortamda bulunan her türlü aşındırıcıları mil ile dudak arasına toplayacağı için mekanik aşınmadan dolayı keçelerin ömrü kısa olur ve yağ kaçağı oluşabilir.
5. Montaj'dan sonra keçenin ölçüsel değerlerine ulaşabilmesi için motor, en az 4 saat sonra çalıştırılmalıdır. Eğer motor daha erken çalıştırılır ise keçe ölçüsel olarak gerçek boyutlarına ulaşılacağı için yağ kaçırrır.

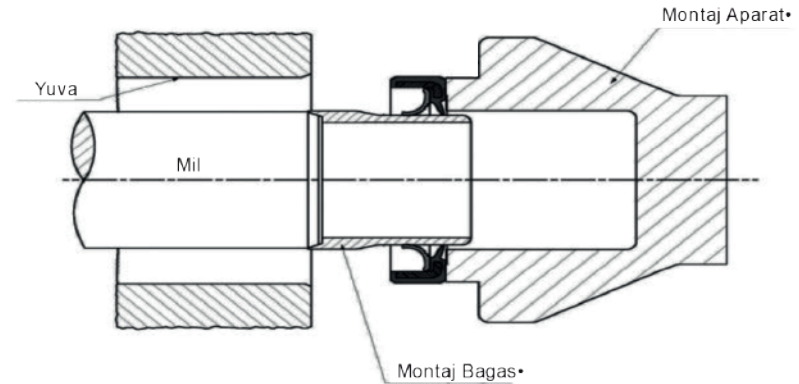

## A. ELASTOMERIC LIP SEALS

1. Shaft and housing need to be clean, undamaged and dimensionally appropriate.
2. Elastomeric lip seals are to be lubricated with the ambient oil before installation.
3. A special installation tool is to be employed and never a hammer.
4. Garter springs are never to be shortened. (Shortened springs cause excessive tightness and eventually more wear of shaft and seal.)
5. Direction of the helical ribs on the sealing lip is to be taken into account.
6. When installing cassette and ABS type seals, hammering metal cases is to be avoided in order to prevent damaging blows, since those seals are very sensitive.
7. Seal runout is to be checked after the installation.
8. Gasket sealant is not to be used unless the housing is very defective.

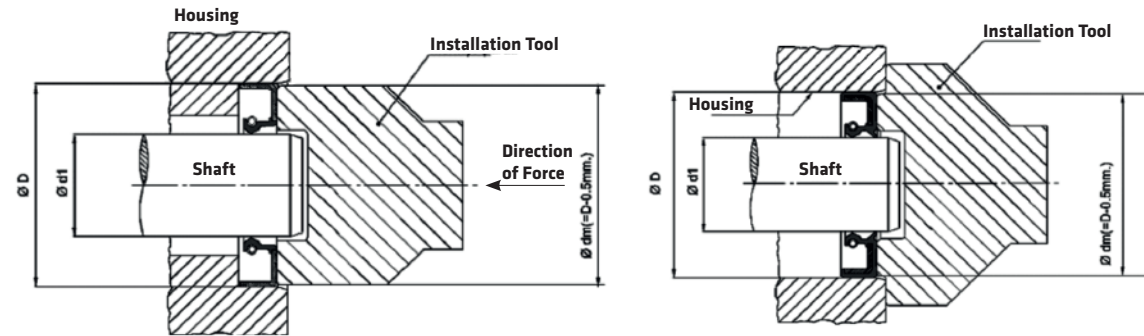

## B. PTFE LIP SEALS

1. Due to being weak in terms of mechanical strength, PTFE lip seals are to be kept from any damages and shaft surface is to be superior. PTFE lip is never to be in contact with hand or metal object.
2. A special installation tool is to be employed and never a hammer.
3. PTFE lip seal installation is to be done with the plastic installation sleeve that comes with the product. Installation sleeve is to be removed after the installation.
4. PTFE lips are not to be lubricated. (PTFE material is suitable for dry running due to its very low coefficient of friction. In case of lubrication, majority of the ambient abrasives are drawn into the lubricant in between the lip and the shaft and this could potentially result in wear and eventually leakage.)
5. Do not start the engine sooner than 4 hours after installation. This permits the new sealing lip to adapt perfectly to the shaft.

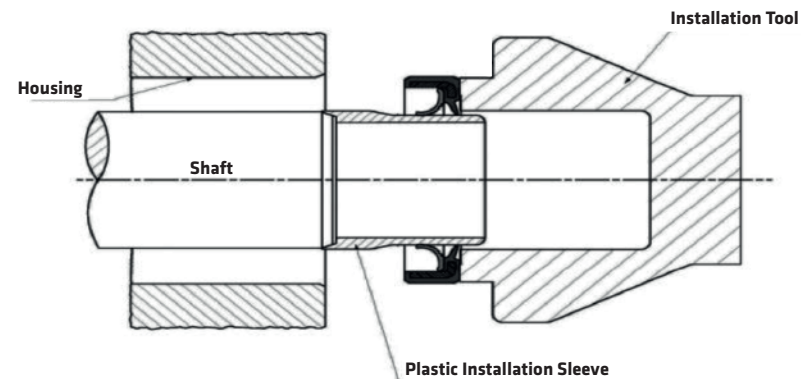

**GENİŞ ÜRÜN ÇEŞİTLİLİĞİ İLE  
İHTİYACINIZI KARŞILAR**

---

**SUPPLIES YOUR NEEDS WITH  
A WIDE PRODUCT RANGE**

**MARKA  
MODEL**

Brand  
Model

**MOTOR  
GRUBU**

Engine  
Group

**AKS  
GRUBU**

Axle  
Group

**DİĞER  
ÜRÜNLER**

Other  
Parts

**ŞANZİMAN  
GRUBU**

Gearbox  
Group

**DİREKSİYON  
GRUBU**

Steering  
Group

**DİFERANSİYEL  
GRUBU**

Differential  
Group

## MOTOR GRUBU / Engine Group

SKT NO	KULLANILAN MODELLER Models	KULLANIM YERİ Place Of Use	ORJINAL NO 1 Orijinal No 1	ORJINAL NO 1 Orijinal No 2	EŞDEĞER NO 1 Equivalent No 1	EŞDEĞER NO 1 Equivalent No 2	ÖLÇÜLER MM. Dimensions-MM.					TİP Type	MALZEME Material
047588-V	4x4 TRAKTÖR SERİSİ 4x4 Tractor Series	KRANK ÖN Crank Shaft Front	133566		12014982		57,15	76,45	-	9,52	11,11	L3L SAĞ -Right	FKM
047811-V	4x4 TRAKTÖR SERİSİ 4x4 Tractor Series	KRANK ÖN Crank Shaft Front	025303		12014700		70,00	90,00	-	10,00	-	L13TL SAĞ -Right	FKM
415171-V	TRAKTÖR SERİSİ Tractor Series	KRANK ARKA Crank Shaft Rear	2418F475	1447691M1	12010753	15026903	133,35	158,94	159,16	11,11	13,00	L13TL SOL -Left	FKM
415137-V	4x4 TRAKTÖR SERİSİ 4x4 Tractor Series	KRANK ARKA Crank Shaft Rear	2418F475	1447691M1	12010753	15026903	133,35	159,05	-	11,11	-	L3L SOL -Left	FKM
040592	4x4 TRAKTÖR SERİSİ 4x4 Tractor Series	YAĞ POMPASI Oil Pump	25107	425107	12011114		20,00	30,00	-	7,00	-	L3L	NBR
041174	4x4 TRAKTÖR SERİSİ 4x4 Tractor Series	YAKIT POMPASI Fuel Pump	025109		12011122	12010846	25,00	35,00	-	7,00	-	L3	NBR

## AKS ve DİFERANSİYEL GRUBU / Axle and Differential Group

SKT NO	KULLANILAN MODELLER Models	KULLANIM YERİ Place Of Use	ORJINAL NO 1 Orijinal No 1	ORJINAL NO 1 Orijinal No 2	EŞDEĞER NO 1 Equivalent No 1	EŞDEĞER NO 1 Equivalent No 2	ÖLÇÜLER MM. Dimensions-MM.					TİP Type	MALZEME Material
046201-NL	4x4 TRAKTÖR SERİSİ 4x4 Tractor Series	ÖN AKS Front Axle	144485	641735	12014977	993.460	45,00	60,00	-	16,00	-	KOMBI 1X	NBR+TPU
046203-VL	4x4 TRAKTÖR SERİSİ 4x4 Tractor Series	ÖN AKS Front Axle	140224		12017310		48,00	65,00	-	16,50	-	KOMBI 1X	FKM+TPU
410333	TRAKTÖR SERİSİ Tractor Series	ÖN AKS Front Axle	025272		12000534		60,00	110,00	-	13,00	-	L3L	NBR
047922-VN	4x4 TRAKTÖR SERİSİ 4x4 Tractor Series	ÖN AKS Front Axle	145050		12018849		65,00	92,00	-	10,00	15,00	SC6	FKM+NBR
047238	4x4 TRAKTÖR SERİSİ 4x4 Tractor Series	ÖN AKS Front Axle	025296		12011200		70,00	100,00	-	10,00	-	L3	NBR
415220	4x4 TRAKTÖR SERİSİ 4x4 Tractor Series	ÖN AKS Front Axle	47700 149380	126323 139279	12016448		130,00	160,00	-	14,50	16,00	SC6	NBR
417132	4x4 TRAKTÖR SERİSİ 4x4 Tractor Series	ÖN AKS Front Axle	045320	047705 126324	12013126		150,00	176,00	-	15,50	16,00	SC6	NBR
417128	4x4 TRAKTÖR SERİSİ 4x4 Tractor Series	ÖN AKS Front Axle	047701 047702	133267 149702	12018035	12014283	150,00	180,00	-	14,50	16,00	SC6	NBR
420074	4x4 TRAKTÖR SERİSİ 4x4 Tractor Series	ÖN AKS Front Axle	140497		12015136		190,00	220,00	-	16,00	18,00	SC6	NBR
046208-NK	4x4 TRAKTÖR SERİSİ 4x4 Tractor Series	ÖN AKS İÇ Front Axle Inner	116723 116722	83952335	12001889		42,00	62,00	-	14,00	-	KOMBI 3	NBR+YÜN



## AKS ve DİFERANSİYEL GRUBU / Axle and Differential Group

SKT NO	KULLANILAN MODELLER Models	KULLANIM YERİ Place Of Use	ORJINAL NO 1 Orijinal No 1	ORJINAL NO 2 Orijinal No 2	EŞDEĞER NO 1 Equivalent No 1	EŞDEĞER NO 2 Equivalent No 2	ÖLÇÜLER MM. Dimensions-MM.					TİP Type	MALZEME Material
047711-V	4x4 TRAKTÖR SERİSİ 4x4 Tractor Series	ÖN AKS-ROTBAŞI Front Axle King Pin	025798		12032025		80,00	100,00	-	10,00	-	L13TL SS- RL	FKM
041331-NK	TRAKTÖR-İŞ MAK.	ÖN AKS DİFERANSİYEL Front Axle-Differential	118516		12001879		30,00	44,00	-	11,00	-	KOMBI 3	NBR+YÜN
041252-NL	4x4 TRAKTÖR SERİSİ 4x4 Tractor Series	ÖN AKS DİFERANSİYEL Front Axle-Differential	126398	144106	12013519	12018617	30,00	44,00	-	14,00	-	KOMBI 1X	NBR+TPU
046199-NK	4x4 TRAKTÖR SERİSİ 4x4 Tractor Series	ÖN AKS DİFERANSİYEL Front Axle-Differential	116722 125944	415722 416722	12001882		35,00	52,00	-	16,00	-	KOMBI 3	NBR+YÜN
045665	4x4 TRAKTÖR SERİSİ 4x4 Tractor Series	ÖN AKS DİFERANSİYEL Front Axle-Differential	025372		12011146		35,00	55,00	-	11,00	-	L3L	NBR
046298-NK	TRAKTÖR-İŞ MAK.	ÖN AKS DİFERANSİYEL Front Axle-Differential	118675	5133736	12001886		40,00	55,00	-	10,00	-	KOMBI 3	NBR+YÜN
046142-NL	4x4 TRAKTÖR SERİSİ 4x4 Tractor Series	ÖN AKS DİFERANSİYEL Front Axle-Differential	144105 126403	82920208 3696168M1	12013464		40,00	60,00	-	18,50	-	KOMBI 1X	NBR+TPU
046300-NK	4x4 TRAKTÖR SERİSİ 4x4 Tractor Series	ÖN AKS DİFERANSİYEL Front Axle-Differential	123208		12011969		45,00	65,00	-	12,00	-	KOMBI 3	NBR+YÜN
046202-NL	4x4 TRAKTÖR SERİSİ 4x4 Tractor Series	ÖN AKS DİFERANSİYEL Front Axle-Differential	127684		12012377		45,00	65,00	-	18,50	-	KOMBI 1X	NBR+TPU
046082-NL	4x4 TRAKTÖR SERİSİ 4x4 Tractor Series	ÖN AKS DİFERANSİYEL Front Axle-Differential	142652	215291590	12018030		45,00	65,00	-	25,00	-	L13XTLL	NBR+TPU
046083	4x4 TRAKTÖR SERİSİ 4x4 Tractor Series	ÖN AKS DİFERANSİYEL Front Axle-Differential	132741		12015392		45,00	70,00	-	14,00	17,00	SC6	NBR
046073	4x4 TRAKTÖR SERİSİ 4x4 Tractor Series	ÖN AKS DİFERANSİYEL Front Axle-Differential	47210034	5106065	12000514		45,00	75,00	-	10,00	8,00	L3L	NBR
046072	4x4 TRAKTÖR SERİSİ 4x4 Tractor Series	ÖN AKS DİFERANSİYEL Front Axle-Differential	115715	5122548 30401600	12006467		50,00	62,00	-	5,00	7,00	L5L	NBR
046223-NL	4x4 TRAKTÖR SERİSİ 4x4 Tractor Series	ÖN AKS DİFERANSİYEL Front Axle-Differential	536483		12014048		50,00	72,00	-	16,50	-	KOMBI 1X	NBR+TPU
047349	4x4 TRAKTÖR SERİSİ 4x4 Tractor Series	ÖN AKS DİFERANSİYEL Front Axle-Differential	47210029	1442250X1	12014929		50,00	80,00	-	8,00	-	L3	NBR
046071	4x4 TRAKTÖR SERİSİ 4x4 Tractor Series	ÖN AKS DİFERANSİYEL Front Axle-Differential	025124		12006469		56,00	70,00	-	8,00	10,00	L5L	NBR
047920-NL	4x4 TRAKTÖR SERİSİ 4x4 Tractor Series	ÖN AKS DİFERANSİYEL Front Axle-Differential	118899	139420	12001902		58,00	82,00	-	15,00	-	KOMBI 1X	NBR+TPU
047920-VL	4x4 TRAKTÖR SERİSİ 4x4 Tractor Series	ÖN AKS DİFERANSİYEL Front Axle-Differential	139420		12017237		58,00	82,00	-	16,00	-	KOMBI 1X	FKM+TPU

## AKS ve DİFERANSİYEL GRUBU / Axle and Differential Group

SKT NO	KULLANILAN MODELLER Models	KULLANIM YERİ Place Of Use	ORJINAL NO 1 Original No 1	ORJINAL NO 2 Original No 2	EŞDEĞER NO 1 Equivalent No 1	EŞDEĞER NO 2 Equivalent No 2	ÖLÇÜLER MM. Dimensions-MM.					TİP Type	MALZEME Material
047921	4x4 TRAKTÖR SERİSİ 4x4 Tractor Series	ÖN AKS DİFERANSİYEL Front Axle-Differential	141876		12018177		62,00	78,00	81,00	10,00	13,80	SPSC	NBR
047896-NK	4x4 TRAKTÖR SERİSİ 4x4 Tractor Series	ÖN AKS DİFERANSİYEL Front Axle-Differential	119990	3957804	12001903		65,00	92,00	-	14,00	-	KOMBI 3	NBR+YÜN
047923	4x4 TRAKTÖR SERİSİ 4x4 Tractor Series	ÖN AKS DİFERANSİYEL Front Axle-Differential	141877		12018176		73,00	89,50	92,50	10,00	13,80	SPSC	NBR
417127	4x4 TRAKTÖR SERİSİ 4x4 Tractor Series	ÖN AKS DİFERANSİYEL Front Axle-Differential	140368		12015149		165,00	195,00	-	16,50	18,00	SC6	NBR
4200 69-NK	4x4 TRAKTÖR SERİSİ 4x4 Tractor Series	ÖN AKS DİFERANSİYEL Front Axle-Differential	30199660X1	5133736	12001926		190,00	220,00	-	20,00	-	KOMBI 3	NBR+YÜN
046298-NK	4x4 TRAKTÖR SERİSİ 4x4 Tractor Series	ÖN AKS DİFERANSİYEL Front Axle-Differential	118675	5133736	12001886		40,00	55,00	-	10,00	-	KOMBI 3	NBR+ YÜN
045700	4x4 TRAKTÖR SERİSİ 4x4 Tractor Series	DİFERANSİYEL SİSTEMİ Differential System	025353	903074426	12011160		40,00	62,00	-	10,00	-	L3L	NBR
046076	4x4 TRAKTÖR SERİSİ 4x4 Tractor Series	DİFERANSİYEL SİSTEMİ Differential System	025353		12011160		40,00	62,00	-	10,00	7,00	L3L	NBR
046297-NL	4x4 TRAKTÖR SERİSİ 4x4 Tractor Series	DİFERANSİYEL SİSTEMİ Differential System	139101		12016507		42,00	62,00	-	21,50	-	KOMBI 1X	NBR-TPU
045779	4x4 TRAKTÖR SERİSİ 4x4 Tractor Series	DİFERANSİYEL SİSTEMİ Differential System	025218 597356	225218 425218	12011168		45,00	65,00	-	10,00	-	L3L	NBR
045934	4x4 TRAKTÖR SERİSİ 4x4 Tractor Series	DİFERANSİYEL SİSTEMİ Differential System	025226	025228	12011177	12010971	50,00	72,00	-	7,00	-	L3BTL	NBR
047689	4x4 TRAKTÖR SERİSİ 4x4 Tractor Series	DİFERANSİYEL SİSTEMİ Differential System	47210005		12011780		50,00	90,00	-	10,00	-	L3TL	NBR
047674	4x4 TRAKTÖR SERİSİ 4x4 Tractor Series	DİFERANSİYEL SİSTEMİ Differential System	128530	025249	12015749 12011187	01029598	55,00	80,00	-	10,00	-	L3TL	NBR
047706	4x4 TRAKTÖR SERİSİ 4x4 Tractor Series	DİFERANSİYEL SİSTEMİ Differential System	47210027		12001709		60,00	80,00	-	7,00	-	L3BTL	NBR
047718	4x4 TRAKTÖR SERİSİ 4x4 Tractor Series	DİFERANSİYEL SİSTEMİ Differential System	025354	425354	12011192		60,00	80,00	-	10,00	-	L3TL	NBR
047695	4x4 TRAKTÖR SERİSİ 4x4 Tractor Series	DİFERANSİYEL SİSTEMİ Differential System	025499	25373	12011195		65,00	85,00	-	10,00	-	L3TL	NBR
047883	4x4 TRAKTÖR SERİSİ 4x4 Tractor Series	DİFERANSİYEL SİSTEMİ Differential System	025278		12011196		65,00	90,00	-	10,00	-	L3L	NBR
047700	4x4 TRAKTÖR SERİSİ 4x4 Tractor Series	DİFERANSİYEL SİSTEMİ Differential System	025296		12011200	12011017	70,00	100,00	-	10,00	-	L3TL	NBR
047756	4x4 TRAKTÖR SERİSİ 4x4 Tractor Series	DİFERANSİYEL SİSTEMİ Differential System	71354	128544	12011201		75,00	95,00	-	10,00	-	L13TL SS-RL	NBR

## AKS ve DİFERANSİYEL GRUBU / Axle and Differential Group

SKT NO	KULLANILAN MODELLER Models	KULLANIM YERİ Place Of Use	ORJINAL NO 1 Orijinal No 1	ORJINAL NO 2 Orijinal No 2	EŞDEĞER NO 1 Equivalent No 1	EŞDEĞER NO 2 Equivalent No 2	ÖLÇÜLER MM. Dimensions-MM.					TİP Type	MALZEME Material
045226	4x4 TRAKTÖR SERİSİ 4x4 Tractor Series	DİF.ÖN-MAHRUTİ Differential Front	134375	000051300	12011158		40,00	60,00	-	10,00	-	L3L	NBR
410518-NK	TRAKTÖR SERİSİ Tractor Series	ARKA AKS Rear Axle	119768		12001907		75,00	102,00	-	14,00	-	KOMBI 3	NBR+YÜN
410405	4x4 TRAKTÖR SERİSİ 4x4 Tractor Series	ARKA AKS Rear Axle	118614		12001908		80,00	110,00	-	16,00	-	KOMBI 3	NBR+TPU
410449	4x4 TRAKTÖR SERİSİ 4x4 Tractor Series	ARKA AKS Rear Axle	133431		12016635	12014974	85,00	110,00	-	14,50	-	SC6	NBR
412278-NK	4x4 TRAKTÖR SERİSİ 4x4 Tractor Series	ARKA AKS Rear Axle	118676		12001912		100,00	130,00	-	16,00	-	KOMBI 3	NBR+TPU
415219	TRAKTÖR SERİSİ Tractor Series	ARKA AKS KOVAN Rear Axle	-		12016688		140,00	170,00	-	14,50	16,00	SC6	NBR
415219-V	TRAKTÖR SERİSİ Tractor Series	ARKA AKS KOVAN Rear Axle	-		12016451		140,00	170,00	-	14,50	16,00	SC6	FKM
410485	TRAKTÖR SERİSİ Tractor Series	ARKA AKS DIŞ Rear Axle Outer	2162850	728852	12018598		73,00	101,60	-	14,50	15,50	SC6	NBR
410252	4x4 TRAKTÖR SERİSİ 4x4 Tractor Series	ARKA AKS İÇ Rear Axle Inner	025376	47210019	12011206	12011036	85,00	110,00	-	12,00	-	L3L	NBR
040290	4x4 TRAKTÖR SERİSİ 4x4 Tractor Series	FREN MİLİ Brake Shaft	025311	90374376	12010923		38,00	50,00	-	7,00	-	L3	NBR

## ŞANZİMAN GRUBU / Gearbox Group

SKT NO	KULLANILAN MODELLER Models	KULLANIM YERİ Place Of Use	ORJINAL NO 1 Orijinal No 1	ORJINAL NO 2 Orijinal No 2	EŞDEĞER NO 1 Equivalent No 1	EŞDEĞER NO 2 Equivalent No 2	ÖLÇÜLER MM. Dimensions-MM.					TİP Type	MALZEME Material
045948	4x4 TRAKTÖR SERİSİ 4x4 Tractor Series	ŞANZ. KAVRAMA MİLİ Gearbox - Coupling Shaft	6077583	5168314	12011147		35,00	62,00	-	7,00	-	L3TL	NBR
047746-V	4x4 TRAKTÖR SERİSİ 4x4 Tractor Series	ŞANZİMAN ÖN Gearbox Front	134901		12015924	12014854	60,00	80,00	-	8,00	-	L3	FKM
040591	4x4 TRAKTÖR SERİSİ 4x4 Tractor Series	ŞANZİMAN MİLİ Gearbox Shaft	025145		12011111		16,00	28,00	-	7,00	-	L3L	NBR
041160	4x4 TRAKTÖR SERİSİ 4x4 Tractor Series	ŞANZİMAN MİLİ Gearbox Shaft	597138	025107	12011114		20,00	30,00	-	7,00	-	L3	NBR
040434	4x4 TRAKTÖR SERİSİ 4x4 Tractor Series	ŞANZİMAN MİLİ Gearbox Shaft	025141		12000623		22,00	28,00	-	4,00	-	L2	NBR
040713	4x4 TRAKTÖR SERİSİ 4x4 Tractor Series	ŞANZİMAN MİLİ Gearbox Shaft	025794		01026703		22,00	35,00	-	7,00	-	L3L	NBR
040745	4x4 TRAKTÖR SERİSİ 4x4 Tractor Series	ŞANZİMAN MİLİ Gearbox Shaft	025109		12011122		25,00	35,00	-	7,00	-	L3TL	NBR

## ŞANZIMAN GRUBU / Gearbox Group

SKT NO	KULLANILAN MODELLER Models	KULLANIM YERİ Place Of Use	ORJINAL NO 1 Orijinal No 1	ORJINAL NO 1 Orijinal No 2	EŞDEĞER NO 1 Equivalent No 1	EŞDEĞER NO 1 Equivalent No 2	ÖLÇÜLER MM. Dimensions-MM.					TİP Type	MALZEME Material
040756	4x4 TRAKTÖR SERİSİ 4x4 Tractor Series	ŞANZIMAN MİLİ Gearbox Shaft	025126		12011130		28,00	47,00	-	7,00	-	L3L	NBR
040765	4x4 TRAKTÖR SERİSİ 4x4 Tractor Series	ŞANZIMAN MİLİ Gearbox Shaft	025498	6077570	12011131		30,00	40,00	-	7,00	-	L3L	NBR
040761	4x4 TRAKTÖR SERİSİ 4x4 Tractor Series	ŞANZIMAN MİLİ Gearbox Shaft	47210036		12000480		30,00	47,00	-	7,00	-	L3TL	NBR
046041-P	4x4 TRAKTÖR SERİSİ 4x4 Tractor Series	ŞANZ. İŞTİRAK DIŞLISI Gearbox - Overgear	130056	5119206	12011392		30,00	72,00	-	10,00	-	SLL	ACM
040287	4x4 TRAKTÖR SERİSİ 4x4 Tractor Series	ŞANZIMAN MİLİ Gearbox Shaft	29740522 44881597	5110485 5110487	12011139		32,00	45,00	-	7,00	-	L3	NBR
045254	4x4 TRAKTÖR SERİSİ 4x4 Tractor Series	ŞANZIMAN MİLİ Gearbox Shaft	025158		12010914		35,00	62,00	-	10,00	-	L3	NBR
045405	4x4 TRAKTÖR SERİSİ 4x4 Tractor Series	ŞANZIMAN MİLİ Gearbox Shaft	025193		12010940		40,00	72,00	-	10,00	-	L3	NBR
046209-V	4x4 TRAKTÖR SERİSİ 4x4 Tractor Series	ŞANZIMAN MİLİ Gearbox Shaft	025393		01012588		52,00	72,00	-	8,00	-	L3T	FKM
047229	4x4 TRAKTÖR SERİSİ 4x4 Tractor Series	ŞANZIMAN MİLİ Gearbox Shaft	025791	025794	12014022		70,00	85,00	-	8,00	-	L3	NBR
045906	4x4 TRAKTÖR SERİSİ 4x4 Tractor Series	PTO KUYRUK MİLİ Power Take Off Shaft	025351	47210026	12011144	12010907	35,00	52,00	-	7,00	-	L3TL	NBR
045224	4x4 TRAKTÖR SERİSİ 4x4 Tractor Series	PTO KUYRUK MİLİ Power Take Off Shaft	025156		12010910		35,00	56,00	-	10,00	-	L3	NBR

## MİL KEÇELERİ / Shaft Seals

SKT NO	KULLANILAN MODELLER Models	KULLANIM YERİ Place Of Use	ORJINAL NO 1 Orijinal No 1	ORJINAL NO 1 Orijinal No 2	EŞDEĞER NO 1 Equivalent No 1	EŞDEĞER NO 1 Equivalent No 2	ÖLÇÜLER MM. Dimensions-MM.					TİP Type	MALZEME Material
040599	4x4 TRAKTÖR SERİSİ 4x4 Tractor Series	MİL KEÇESİ Shaft Seal	025118		12011109		15,00	30,00	-	7,00	-	L3L	NBR
040439	4x4 TRAKTÖR SERİSİ 4x4 Tractor Series	MİL KEÇESİ Shaft Seal	141836		12011384		16,00	22,00	-	3,00	-	L2	NBR
041060-P	4x4 TRAKTÖR SERİSİ 4x4 Tractor Series	MİL KEÇESİ Shaft Seal	025176		12013159		18,00	28,00	-	6,50	-	L3TL	ACM
040864	4x4 TRAKTÖR SERİSİ 4x4 Tractor Series	MİL KEÇESİ Shaft Seal	6077556		12011119		20,00	47,00	-	7,00	-	L3TL	NBR

## MİL KEÇELERİ / Shaft Seals

SKT NO	KULLANILAN MODELLER Models	KULLANIM YERİ Place Of Use	ORJINAL NO 1 Orijinal No 1	ORJINAL NO 2 Orijinal No 2	EŞDEĞER NO 1 Equivalent No 1	EŞDEĞER NO 2 Equivalent No 2	ÖLÇÜLER MM. Dimensions-MM.					TİP Type	MALZEME Material
040278	4x4 TRAKTÖR SERİSİ 4x4 Tractor Series	MİL KEÇESİ Shaft Seal	025115		12010836		22,00	35,00	-	7,00	-	L3	NBR
040311	4x4 TRAKTÖR SERİSİ 4x4 Tractor Series	MİL KEÇESİ Shaft Seal	025240		12010842		24,00	37,00	-	7,00	-	L3	NBR
040805	4x4 TRAKTÖR SERİSİ 4x4 Tractor Series	MİL KEÇESİ Shaft Seal	025286	6077507	12011124		25,00	42,00	-	7,00	-	L3L	NBR
041165	4x4 TRAKTÖR SERİSİ 4x4 Tractor Series	MİL KEÇESİ Shaft Seal	025112	6077508	12010858 12011125		25,00	47,00	-	7,00	-	L3TL	NBR
045944	4x4 TRAKTÖR SERİSİ 4x4 Tractor Series	MİL KEÇESİ Shaft Seal	025123	6077522	12011126	12010861	25,00	52,00	-	7,00	-	L3TL	NBR
045372	4x4 TRAKTÖR SERİSİ 4x4 Tractor Series	MİL KEÇESİ Shaft Seal	025123		12011126		25,00	52,00	-	7,00	-	L3	NBR
040273	4x4 TRAKTÖR SERİSİ 4x4 Tractor Series	MİL KEÇESİ Shaft Seal	025122		12000129		28,00	38,00	-	7,00	-	L3	NBR
040204	4x4 TRAKTÖR SERİSİ 4x4 Tractor Series	MİL KEÇESİ Shaft Seal	025126		12011130		28,00	47,00	-	10,00	-	L3	NBR
041139-P	4x4 TRAKTÖR SERİSİ 4x4 Tractor Series	MİL KEÇESİ Shaft Seal	138343		12014825		29,80	50,00	-	10,00	13,50	L13TL SAĞ -Right	ACM
040872	4x4 TRAKTÖR SERİSİ 4x4 Tractor Series	MİL KEÇESİ Shaft Seal	025308		12010895		32,00	47,00	-	7,00	-	L3TL	NBR
040851-V	4x4 TRAKTÖR SERİSİ 4x4 Tractor Series	MİL KEÇESİ Shaft Seal	140852		12001836		35,00	47,00	-	6,00	-	L3BTL	FKM
040607	4x4 TRAKTÖR SERİSİ 4x4 Tractor Series	MİL KEÇESİ Shaft Seal	025146		12011143		35,00	47,00	-	7,00	-	L3L	NBR
040205	4x4 TRAKTÖR SERİSİ 4x4 Tractor Series	MİL KEÇESİ Shaft Seal	025153		12010906		35,00	50,00	-	10,00	-	L3	NBR
045926	4x4 TRAKTÖR SERİSİ 4x4 Tractor Series	MİL KEÇESİ Shaft Seal	215290430		12001690	01001689	35,00	52,00	-	6,00	-	L3BTL	NBR
045323	4x4 TRAKTÖR SERİSİ 4x4 Tractor Series	MİL KEÇESİ Shaft Seal	47210022		12014807		35,00	68,00	-	10,00	-	L3	NBR
045909	4x4 TRAKTÖR SERİSİ 4x4 Tractor Series	MİL KEÇESİ Shaft Seal	025163	6077536	12010915	12013421	35,00	72,00	-	10,00	-	L3T	NBR
045497	4x4 TRAKTÖR SERİSİ 4x4 Tractor Series	MİL KEÇESİ Shaft Seal	025486		12010924		38,00	52,00	-	7,00	-	L3	NBR
045388	4x4 TRAKTÖR SERİSİ 4x4 Tractor Series	MİL KEÇESİ Shaft Seal	025184		12010931		40,00	52,00	-	7,00	-	L3	NBR

## MİL KEÇELERİ / Shaft Seals

SKT NO	KULLANILAN MODELLER Models	KULLANIM YERİ Place Of Use	ORJINAL NO 1 Orijinal No 1	ORJINAL NO 2 Orijinal No 2	EŞDEĞER NO 1 Equivalent No 1	EŞDEĞER NO 2 Equivalent No 2	ÖLÇÜLER MM. Dimensions-MM.					TİP Type	MALZEME Material
045241	4x4 TRAKTÖR SERİSİ 4x4 Tractor Series	MİL KEÇESİ Shaft Seal	025187		12010936		40,00	62,00	-	10,00	-	L3	NBR
045505	4x4 TRAKTÖR SERİSİ 4x4 Tractor Series	MİL KEÇESİ Shaft Seal	025350		12011163		42,00	62,00	-	10,00	-	L3	NBR
045516	4x4 TRAKTÖR SERİSİ 4x4 Tractor Series	MİL KEÇESİ Shaft Seal	025588		12013433		45,00	58,00	-	7,00	-	L3	NBR
047545	4x4 TRAKTÖR SERİSİ 4x4 Tractor Series	MİL KEÇESİ Shaft Seal	025942		12000259	12000516	45,00	85,00	-	10,00	-	L3L	NBR
045932	4x4 TRAKTÖR SERİSİ 4x4 Tractor Series	MİL KEÇESİ Shaft Seal	025213		12000518		47,00	62,00	-	7,00	-	L3BTL	NBR
046173	4x4 TRAKTÖR SERİSİ 4x4 Tractor Series	MİL KEÇESİ Shaft Seal	132742		12015395		48,00	75,00	-	14,00	17,00	SC6	NBR
045731	4x4 TRAKTÖR SERİSİ 4x4 Tractor Series	MİL KEÇESİ Shaft Seal	025484		01020676		50,00	65,00	-	8,00	-	L1L	NBR
045543	4x4 TRAKTÖR SERİSİ 4x4 Tractor Series	MİL KEÇESİ Shaft Seal	025246		12010981		55,00	70,00	-	8,00	-	L3	NBR
045151	4x4 TRAKTÖR SERİSİ 4x4 Tractor Series	MİL KEÇESİ Shaft Seal	025313		12010983		55,00	72,00	-	10,00	-	L3	NBR
047446	4x4 TRAKTÖR SERİSİ 4x4 Tractor Series	MİL KEÇESİ Shaft Seal	6077515		12011190		58,00	80,00	-	10,00	-	L3	NBR
045355	4x4 TRAKTÖR SERİSİ 4x4 Tractor Series	MİL KEÇESİ Shaft Seal	025485		12011191		60,00	75,00	-	8,00	-	L3	NBR
047087	4x4 TRAKTÖR SERİSİ 4x4 Tractor Series	MİL KEÇESİ Shaft Seal	025267		12010999	12011192	60,00	80,00	-	10,00	-	L3	NBR
047456	4x4 TRAKTÖR SERİSİ 4x4 Tractor Series	MİL KEÇESİ Shaft Seal	025354	425354	12011192	12010999 12015900	60,00	80,00	-	10,00	12,00	L3L	NBR
047450	4x4 TRAKTÖR SERİSİ 4x4 Tractor Series	MİL KEÇESİ Shaft Seal	025373		12011007	12011008	65,00	85,00	-	10,00	-	L3	NBR
047847	4x4 TRAKTÖR SERİSİ 4x4 Tractor Series	MİL KEÇESİ Shaft Seal	025499		12011195		65,00	85,00	-	10,00	-	L3L	NBR
047697	4x4 TRAKTÖR SERİSİ 4x4 Tractor Series	MİL KEÇESİ Shaft Seal	025287		12011011		65,00	100,00	-	10,00	-	L3TL	NBR
047054	4x4 TRAKTÖR SERİSİ 4x4 Tractor Series	MİL KEÇESİ Shaft Seal	6077524		12011019		72,00	100,00	-	10,00	-	L3	NBR
047272	4x4 TRAKTÖR SERİSİ 4x4 Tractor Series	MİL KEÇESİ Shaft Seal	025306		12011201		75,00	95,00	-	10,00	-	L3	NBR

## MİL KEÇELERİ / Shaft Seals

SKT NO	KULLANILAN MODELLER Models	KULLANIM YERİ Place Of Use	ORJINAL NO 1 Orijinal No 1	ORJINAL NO 1 Orijinal No 2	EŞDEĞER NO 1 Equivalent No 1	EŞDEĞER NO 1 Equivalent No 2	ÖLÇÜLER MM. Dimensions-MM.					TİP Type	MALZEME Material
410052	4x4 TRAKTÖR SERİSİ 4x4 Tractor Series	MİL KEÇESİ Shaft Seal	025305		12000542		75,00	110,00	-	12,00	-	L3	NBR
047474	4x4 TRAKTÖR SERİSİ 4x4 Tractor Series	MİL KEÇESİ Shaft Seal	425382	968908R91	12011204		80,00	100,00	-	13,00	-	L3L	NBR
0410121	4x4 TRAKTÖR SERİSİ 4x4 Tractor Series	MİL KEÇESİ Shaft Seal	025799	333626	12011055		100,00	120,00	-	12,00	-	L3	NBR
0412272	4x4 TRAKTÖR SERİSİ 4x4 Tractor Series	MİL KEÇESİ Shaft Seal	025335		12000552		100,00	130,00	-	13,00	-	L3TL	NBR
0412025	4x4 TRAKTÖR SERİSİ 4x4 Tractor Series	MİL KEÇESİ Shaft Seal	025343		12000556		120,00	140,00	-	13,00	-	L3	NBR

## DİĞER GRUPLAR / Others Group

SKT NO	KULLANILAN MODELLER Models	KULLANIM YERİ Place Of Use	ORJINAL NO 1 Orijinal No 1	ORJINAL NO 1 Orijinal No 2	EŞDEĞER NO 1 Equivalent No 1	EŞDEĞER NO 1 Equivalent No 2	ÖLÇÜLER MM. Dimensions-MM.					TİP Type	MALZEME Material
040862	4x4 TRAKTÖR SERİSİ 4x4 Tractor Series	DİREKSİYON MİLİ Steering Shaft	025000		19027773		20,00	35,00	-	7,00	-	L3TL	NBR
040843	4x4 TRAKTÖR SERİSİ 4x4 Tractor Series	DİREKSİYON MİLİ Steering Shaft	025606		12011519		24,00	40,00	-	7,00	-	L3BTL	NBR
040851	4x4 TRAKTÖR SERİSİ 4x4 Tractor Series	DİREKSİYON MİLİ Steering Shaft	47207006		12001688		35,00	47,00	-	6,00	-	L3BTL	NBR
040743	4x4 TRAKTÖR SERİSİ 4x4 Tractor Series	DİREKSİYON SİSTEMİ Steering System	025548		12014826		26,00	37,00	-	7,00	8,00	L3BTL	NBR
040610	4x4 TRAKTÖR SERİSİ 4x4 Tractor Series	HİDROLİK POMPA Hydraulic Pump	025539		12011127		26,00	37,00	-	7,00	8,00	L3L	NBR
045150	4x4 TRAKTÖR SERİSİ 4x4 Tractor Series	HİDROLİK KOL MİLİ Hydraulic Arm Shaft	025216	5086120	12000519 12010963		48,00	65,00	-	10,00	-	L3	NBR

## MOTOR GRUBU / Engine Group

SKT NO	KULLANILAN MODELLER Models	KULLANIM YERİ Place Of Use	ORJINAL NO 1 Orijinal No 1	ORJINAL NO 2 Orijinal No 2	EŞDEĞER NO 1 Equivalent No 1	EŞDEĞER NO 2 Equivalent No 2	ÖLÇÜLER MM. Dimensions-MM.					TİP Type	MALZEME Material
047588-V	TRAKTÖR SERİSİ Tractor Series	KRANK ÖN Crank Shaft Front	295810A1		12014982		57,15	76,45	-	9,52	11,11	L3L SAĞ -Right	FKM
047558-V	TRAKTÖR SERİSİ Tractor Series	KRANK ÖN Crank Shaft Front	218375A1		12014981		60,33	79,62	-	9,52	11,11	L3L SAĞ -Right	FKM
047894-V	TRAKTÖR SERİSİ Tractor Series	KRANK ÖN Crank Shaft Front	218375A1		12014981	578.010	60,33	79,63	-	9,33	11,23	L3TL SAĞ -Right	FKM
047498-S	TRAKTÖR SERİSİ Tractor Series	KRANK ÖN Crank Shaft Front	3228401R91	3085309R91 3136881R92	12011821		80,00	100,00	-	13,00	-	L1L SAĞ -Right	VMQ
412189-S	TRAKTÖR SERİSİ Tractor Series	KRANK ARKA Crank Shaft Rear	3138701R91	1966693C1	12012521		110,00	130,00	-	13,00	-	L1L SOL -Left	VMQ
412189-V	TRAKTÖR SERİSİ Tractor Series	KRANK ARKA Crank Shaft Rear	3138701R91	1966693C1	12012521		110,00	130,00	-	13,00	-	L1L SOL -Left	FKM
412235-V	TRAKTÖR SERİSİ Tractor Series	KRANK ARKA Crank Shaft Rear	40003800	99457401	12016274	12014858	114,00	135,00	-	13,00	-	L1L SOL -Left	FKM
412281-V	TRAKTÖR SERİSİ Tractor Series	KRANK ARKA Crank Shaft Rear	98488392	98488395	12016274	12014858	114,00	135,00	-	13,00	-	L13TL SOL -Left	FKM
412092-V	TRAKTÖR SERİSİ Tractor Series	KRANK ARKA Crank Shaft Rear	K306765		1014589		115,00	140,00	-	12,00	-	L3	FKM
415171-V	TRAKTÖR SERİSİ Tractor Series	KRANK ARKA Crank Shaft Rear	2418F475	1447691M1	12010753	15026903	133,35	158,94	159,16	11,11	13,00	L13TL SOL -Left	FKM
415137-V	TRAKTÖR SERİSİ Tractor Series	KRANK ARKA Crank Shaft Rear	2418F475	1447691M1	12010753	15026903	133,35	159,05	-	11,11	-	L3L SOL -Left	FKM
415106-S	TRAKTÖR SERİSİ Tractor Series	KRANK ARKA Crank Shaft Rear	218271A1		15026903	12010753	133,35	159,05	-	12,70	-	L3 SOL -Left	VMQ
412092-V	TRAKTÖR SERİSİ Tractor Series	KRANK ARKA Crank Shaft Rear	K306765		12032089		115,00	140,00	-	12,00	-	L3	FKM
45-009-V	TRAKTÖR SERİSİ Tractor Series	SUPAP Valve Stem Seal	736840M1	3637041M1 33817119	12016623	292610	9,45	14,25	16,61	10,69	14,27	L	FKM
040941-V	TRAKTÖR SERİSİ Tractor Series	YAKIT POMPASI Fuel Pump	3078355R2 5001833930	1460283310 42530475	12019583		17,00	28,00	-	7,30	-	L13TL	FKM
45361	TRAKTÖR SERİSİ Tractor Series	SU POMPASI Water Pump	713761R91		12010908		35,00	52,00	-	10,00	-	L3L	NBR



AKS ve DİFERANSİYEL GRUBU / Axle and Differential Group

SKT NO	KULLANILAN MODELLER Models	KULLANIM YERİ Place Of Use	ORJINAL NO 1 Orijinal No 1	ORJINAL NO 2 Orijinal No 2	EŞDEĞER NO 1 Equivalent No 1	EŞDEĞER NO 2 Equivalent No 2	ÖLÇÜLER MM. Dimensions-MM.					TİP Type	MALZEME Material
417132	TRAKTÖR SERİSİ Tractor Series	ÖN AKS Front Axle	247877A1	K395102	12013126		150,00	176,00	-	15,50	16,00	SC6	NBR
417128	TRAKTÖR SERİSİ Tractor Series	ÖN AKS Front Axle	247546A1	87415728	12018035	12014283	150,00	180,00	-	14,50	16,00	SC6	NBR
046208-NK	TRAKTÖR SERİSİ Tractor Series	ÖN AKS İÇ Front Axle Inner	1966164C1	1966164C1	12001889		42,00	62,00	-	14,00	-	KOMBI 3	NBR+YÜN
041331-NK	TRAKTÖR SERİSİ Tractor Series	ÖN AKS DİFERANSİYEL Front Axle-Differential	1966191C1		12001879		30,00	44,00	-	11,00	-	KOMBI 3	NBR+YÜN
046199-NK	TRAKTÖR SERİSİ Tractor Series	ÖN AKS DİFERANSİYEL Front Axle-Differential	295151A1	83949435	12001882		35,00	52,00	-	16,00	-	KOMBI 3	NBR-YÜN
046300-NK	TRAKTÖR SERİSİ Tractor Series	ÖN AKS DİFERANSİYEL Front Axle-Differential	123208	100529A1	12011969		45,00	65,00	-	12,00	-	KOMBI 3	NBR+YÜN
46083	4x4 TRAKTÖR SERİSİ 4x4 Tractor Series	ÖN AKS DİFERANSİYEL Front Axle-Differential	247519A1		12015392		45,00	70,00	-	14,00	17,00	SC6	NBR
046223-NL	4x4 TRAKTÖR SERİSİ 4x4 Tractor Series	ÖN AKS DİFERANSİYEL Front Axle-Differential	87330293		12014048		50,00	72,00	-	16,50	-	KOMBI 1X	NBR+TPU
047920-NL	TRAKTÖR SERİSİ Tractor Series	ÖN AKS DİFERANSİYEL Front Axle-Differential	1966194C1	5194224	12001902		58,00	82,00	-	15,00	-	KOMBI 1X	NBR+TPU
047920-VL	TRAKTÖR SERİSİ Tractor Series	ÖN AKS DİFERANSİYEL Front Axle-Differential	1966194C1	5194224	12017237		58,00	82,00	-	16,00	-	KOMBI 1X	FKM+TPU
415220	TRAKTÖR SERİSİ Tractor Series	ÖN AKS DİFERANSİYEL Front Axle-Differential	311569A1		12016448		130,00	160,00	-	14,50	16,00	SC6	NBR
410405	TRAKTÖR SERİSİ Tractor Series	ARKA AKS Rear Axle	K262144		12001908		80,00	110,00	-	16,00	-	KOMBI 3	NBR+TPU
47545	TRAKTÖR SERİSİ Tractor Series	AKS SİSTEMİ Axle System	3221942R1		12000516		45,00	85,00	-	10,00	-	L3L	NBR
45551	TRAKTÖR SERİSİ Tractor Series	MİL KEÇESİ Shaft Seal	3131160R92		01019463		50,00	70,00	-	10,00	-	SL	NBR

## ŞANZIMAN GRUBU / Gearbox Group

SKT NO	KULLANILAN MODELLER Models	KULLANIM YERİ Place Of Use	ORJINAL NO 1 Orijinal No 1	ORJINAL NO 1 Orijinal No 2	EŞDEĞER NO 1 Equivalent No 1	EŞDEĞER NO 1 Equivalent No 2	ÖLÇÜLER MM. Dimensions-MM.					TİP Type	MALZEME Material
040592	TRAKTÖR SERİSİ Tractor Series	ŞANZIMAN MİLİ Gearbox Shaft	3131571R1	102390	12001623		20,00	30,00	-	7,00	-	L3L	NBR
041175	TRAKTÖR SERİSİ Tractor Series	ŞANZIMAN MİLİ Gearbox Shaft	786446R91		01031611		25,00	33,00	-	6,00	-	L3	NBR
040174	TRAKTÖR SERİSİ Tractor Series	ŞANZIMAN MİLİ Gearbox Shaft	3136663R1		12010879		30,00	40,00	-	7,00	-	L3	NBR
047840-V	TRAKTÖR SERİSİ Tractor Series	ŞANZIMAN-KİLİT MİLİ Gearbox Lock Shaft	85150370	09805057	12013029		35,00	80,00	-	10,00	-	L3L	FKM
040286-V	TRAKTÖR SERİSİ Tractor Series	PTO KUYRUK MİLİ Power Take Off Shaft	87528273		12001163		25,00	40,00	-	7,00	-	L3	FKM

## DİĞER GRUPLAR / Others Group

SKT NO	KULLANILAN MODELLER Models	KULLANIM YERİ Place Of Use	ORJINAL NO 1 Orijinal No 1	ORJINAL NO 1 Orijinal No 2	EŞDEĞER NO 1 Equivalent No 1	EŞDEĞER NO 1 Equivalent No 2	ÖLÇÜLER MM. Dimensions-MM.					TİP Type	MALZEME Material
041121-H	TRAKTÖR SERİSİ Tractor Series	DİREKSİYON MİLİ Steering Shaft	3227967R1		01018101		26,00	37,00	-	7,00	-	L3BT	HNBR
041113	TRAKTÖR SERİSİ Tractor Series	DİREKSİYON MİLİ Steering Shaft	3057808R1		12015561		30,00	37,00	-	4,00	-	L2T	NBR
040978-L	TRAKTÖR SERİSİ Tractor Series	HİDROLİK KAYDIRICI MİL-Flexibar	47129342	5121123	19036935		23,00	38,00	-	12,30	-	L1	TPU-BEYAZ
041209-L	TRAKTÖR SERİSİ Tractor Series	HİDROLİK KAYDIRICI MİL-Flexibar	5121123		19036935		23,00	38,00	-	12,30	-	L1	TPU-KIRMIZI
040838-V	TRAKTÖR SERİSİ Tractor Series	HİDROLİK POMPA Hydraulic Pump	G151415		12011834		18,00	30,00	-	6,00	-	L3BTL	FKM
040158	TRAKTÖR SERİSİ Tractor Series	HİDROLİK POMPA Hydraulic Pump	10570		-	-	22,22	31,87	-	4,76	-	L5	NBR

## AKS ve DİFERANSİYEL GRUBU / Axle and Differential Group

SKT NO	KULLANILAN MODELLER Models	KULLANIM YERİ Place Of Use	ORJİNAL NO 1 Orijinal No 1	ORJİNAL NO 2 Orijinal No 2	EŞDEĞER NO 1 Equivalent No 1	EŞDEĞER NO 2 Equivalent No 2	ÖLÇÜLER MM. Dimensions-MM.					TİP Type	MALZEME Material
046201-NL	TRAKTÖR SERİSİ Tractor Series	ÖN AKS Front Axle	6000104562	00112109	12014977	993.460	45,00	60,00	-	16,00	-	KOMBI 1X	NBR+TPU
046203-VL	TRAKTÖR SERİSİ Tractor Series	ÖN AKS Front Axle	6000104488		12017310		48,00	65,00	-	16,50	-	KOMBI 1X	FKM+TPU
417132	4x4 TRAKTÖR SERİSİ 4x4 Tractor Series	ÖN AKS Front Axle	03225110	6000147705	12013126		150,00	176,00	-	15,50	16,00	SC6	NBR
417128	TRAKTÖR SERİSİ Tractor Series	ÖN AKS Front Axle	6005030587	3907166M1	12018035	12014283	150,00	180,00	-	14,50	16,00	SC6	NBR
046208-NK	4x4 TRAKTÖR SERİSİ 4x4 Tractor Series	ÖN AKS İÇ Front Axle Inner	03215560	3475332M1	12001889		42,00	62,00	-	14,00	-	KOMBI 3	NBR+YÜN
041252-NL	TRAKTÖR SERİSİ Tractor Series	ÖN AKS DİFERANSİYEL Front Axle-Differential	6000104540		12013519	12018617	30,00	44,00	-	14,00	-	KOMBI 1X	NBR+TPU
046199-NK	TRAKTÖR SERİSİ Tractor Series	ÖN AKS DİFERANSİYEL Front Axle-Differential	03214990	3541441M1 040936R1	12001882		35,00	52,00	-	16,00	-	KOMBI 3	NBR-YÜN
046298-NK	TRAKTÖR SERİSİ Tractor Series	ÖN AKS DİFERANSİYEL Front Axle-Differential	6000101420		12001886		40,00	55,00	-	10,00	-	KOMBI 3	NBR+YÜN
046297-NL	TRAKTÖR SERİSİ Tractor Series	ÖN AKS DİFERANSİYEL Front Axle-Differential	03495270		12016507		42,00	62,00	-	21,50	-	KOMBI 1X	NBR-TPU
046300-NK	TRAKTÖR SERİSİ Tractor Series	ÖN AKS DİFERANSİYEL Front Axle-Differential	03240590		12011969		45,00	65,00	-	12,00	-	KOMBI 3	NBR+YÜN
047920-NL	TRAKTÖR SERİSİ Tractor Series	ÖN AKS DİFERANSİYEL Front Axle-Differential	6000105275		12001902		58,00	82,00	-	15,00	-	KOMBI 1X	NBR+TPU
047920-VL	TRAKTÖR SERİSİ Tractor Series	ÖN AKS DİFERANSİYEL Front Axle-Differential	6000105275	9967730	12017237		58,00	82,00	-	16,00	-	KOMBI 1X	FKM+TPU
415220	TRAKTÖR SERİSİ Tractor Series	ÖN AKS DİFERANSİYEL Front Axle-Differential	6000105287	6000147703	12016448		130,00	160,00	-	14,50	16,00	SC6	NBR
045934	TRAKTÖR SERİSİ Tractor Series	DİFERANSİYEL SİSTEMİ Differential System	02125760	02348860	12011177		50,00	72,00	-	7,00	-	L3BTL	NBR
047689	TRAKTÖR SERİSİ Tractor Series	DİFERANSİYEL SİSTEMİ Differential System	02126310		12011780		50,00	90,00	-	10,00	-	L3TL	NBR
047706	TRAKTÖR SERİSİ Tractor Series	DİFERANSİYEL SİSTEMİ Differential System	02112530		12001709		60,00	80,00	-	7,00	-	L3BTL	NBR
047718	TRAKTÖR SERİSİ Tractor Series	DİFERANSİYEL SİSTEMİ Differential System	02226780		12011192		60,00	80,00	-	10,00	-	L3TL	NBR
410252	TRAKTÖR SERİSİ Tractor Series	ARKA AKS İÇ Rear Axle Inner	02142060	7700005852	12011206	12011036	85,00	110,00	-	12,00	-	L3L	NBR
045944	TRAKTÖR SERİSİ Tractor Series	AKS SİSTEMİ Axle System	02129270		12011126	12010860	25,00	52,00	-	7,00	-	L3TL	NBR

## AKS ve DİFERANSİYEL GRUBU / Axle and Differential Group

SKT NO	KULLANILAN MODELLER Models	KULLANIM YERİ Place Of Use	ORJINAL NO 1 Original No 1	ORJINAL NO 2 Original No 2	EŞDEĞER NO 1 Equivalent No 1	EŞDEĞER NO 2 Equivalent No 2	ÖLÇÜLER MM. Dimensions-MM.					TİP Type	MALZEME Material
047456	TRAKTÖR SERİSİ Tractor Series	AKS SİSTEMİ Axle System	02226780		12011192	12010999 12015900	60,00	80,00	-	10,00	12,00	L3L	NBR
047450	TRAKTÖR SERİSİ Tractor Series	AKS SİSTEMİ Axle System	7700006256		12011007	12011008	65,00	85,00	-	10,00	-	L3	NBR
047054	TRAKTÖR SERİSİ Tractor Series	AKS SİSTEMİ Axle System	7700013479		12011019		72,00	100,00	-	10,00	-	L3	NBR
047225	TRAKTÖR SERİSİ Tractor Series	MİL KEÇESİ Shaft Seal	02123930		12000367		75,00	90,00	-	8,00	-	L3	NBR
412025	TRAKTÖR SERİSİ Tractor Series	AKS SİSTEMİ Axle System	7700012311		12000556		120,00	140,00	-	13,00	-	L3	NBR
420017	TRAKTÖR SERİSİ Tractor Series	AKS SİSTEMİ Axle System	02153002		12011099		185,00	210,00	-	13,00	-	L3T	NBR

## ŞANZİMAN GRUBU / Gearbox Group

SKT NO	KULLANILAN MODELLER Models	KULLANIM YERİ Place Of Use	ORJINAL NO 1 Original No 1	ORJINAL NO 2 Original No 2	EŞDEĞER NO 1 Equivalent No 1	EŞDEĞER NO 2 Equivalent No 2	ÖLÇÜLER MM. Dimensions-MM.					TİP Type	MALZEME Material
045948	TRAKTÖR SERİSİ Tractor Series	ŞANZ. KAVRAMA MİLİ Gearbox - Coupling Shaft	02118040		12011147		35,00	62,00	-	7,00	-	L3TL	NBR
041160	TRAKTÖR SERİSİ Tractor Series	ŞANZİMAN MİLİ Gearbox Shaft	02371201		12011114		20,00	30,00	-	7,00	-	L3	NBR
045946	TRAKTÖR SERİSİ Tractor Series	ŞANZİMAN MİLİ Gearbox Shaft	02332280	02338240	12011137		30,00	62,00	-	7,00	-	L3TL	NBR
046148	TRAKTÖR SERİSİ Tractor Series	PTO KUYRUK MİLİ Power Take Off Shaft	02389290		12010947		42,00	72,00	-	8,00	-	L3	NBR

## DİĞER GRUPLAR / Others Group

SKT NO	KULLANILAN MODELLER Models	KULLANIM YERİ Place Of Use	ORJINAL NO 1 Original No 1	ORJINAL NO 2 Original No 2	EŞDEĞER NO 1 Equivalent No 1	EŞDEĞER NO 2 Equivalent No 2	ÖLÇÜLER MM. Dimensions-MM.					TİP Type	MALZEME Material
045543	TRAKTÖR SERİSİ Tractor Series	HİD. KALDIRMA SİSTEMİ Hydraulic Lifting System	6000104501		12010981		55,00	70,00	-	8,00	-	L3	NBR
045930	TRAKTÖR SERİSİ Tractor Series	MİL KEÇESİ Shaft Seal	02153380		12001698		45,00	62,00	-	7,00	-	L3BTL	NBR
047575	TRAKTÖR SERİSİ Tractor Series	MİL KEÇESİ Shaft Seal	02382772		12011186		55,00	80,00	-	8,00	-	L3	NBR

# CLAYSON Biçerdöver / Combine Harvester

## MOTOR ve MİL KEÇELERİ / Engine and Shaft Seals

SKT NO	KULLANILAN MODELLER Models	KULLANIM YERİ Place Of Use	ORJINAL NO 1 Orijinal No 1	ORJINAL NO 2 Orijinal No 2	EŞDEĞER NO 1 Equivalent No 1	EŞDEĞER NO 2 Equivalent No 2	ÖLÇÜLER MM. Dimensions-MM.					TİP Type	MALZEME Material
047562-S	DOWER MOTOR Dower Type Engine	KRANK ÖN Crank Shaft Front	-		12015552		66,67	89,70	-	9,52	-	L3TL SAĞ -Right	VMQ
047562-V	DOWER MOTOR Dower Type Engine	KRANK ÖN Crank Shaft Front	-		12015552		66,67	89,70	-	9,52	-	L3TL SAĞ -Right	FKM
413	8055	SU POMPASI Water Pump	-		-		17,50	38,60	-	9,50	20,00	K010	NBR
040284	1530-1545-8040	MİL KEÇESİ Shaft Seal	-		12010808		17,00	30,00	-	7,00	-	L3	NBR
040611	1530-1545	MİL KEÇESİ Shaft Seal	-		12010808		17,00	30,00	-	8,00	-	L3L	NBR
040558	8040	MİL KEÇESİ Shaft Seal	-		01033709		20,00	40,00	-	7,00	8,00	L3BL	NBR
040537	8040	MİL KEÇESİ Shaft Seal	-		-		22,22	38,17	-	9,52	-	L1BL	NBR
040745	8040-8055-8061	MİL KEÇESİ Shaft Seal	-		12011122		25,00	35,00	-	7,00	-	L3TL	NBR
040328	8040	MİL KEÇESİ Shaft Seal	-		12015561		30,00	37,00	-	4,00	-	L5	NBR
041113	8040	MİL KEÇESİ Shaft Seal	-		12015561		30,00	37,00	-	4,00	-	L2T	NBR
040169	1530-1545	MİL KEÇESİ Shaft Seal	-		-		30,00	45,00	-	10,00	-	L3	NBR
045389	8040-8055-8061	MİL KEÇESİ Shaft Seal	-		12010886		30,00	52,00	-	8,00	-	L3	NBR
040536	8040	MİL KEÇESİ Shaft Seal	-		12016519		35,00	42,00	-	4,00	-	L5	NBR
045224	1530-1545-8040	MİL KEÇESİ Shaft Seal	-		12010910		35,00	56,00	-	10,00	-	L3	NBR
045495	1530-1545-8040	MİL KEÇESİ Shaft Seal	-		12000229		40,00	68,00	-	10,00	-	L3	NBR
045405	8040-8055-8061	MİL KEÇESİ Shaft Seal	-		12010940		40,00	72,00	-	10,00	-	L3	NBR
046019-Z	1530-1545	MİL KEÇESİ Shaft Seal	-		01032054		40,00	72,00	-	10,00	-	L3TL	NBR
047405	8040	MİL KEÇESİ Shaft Seal	-		-		48,00	80,00	-	8,00	-	L3	NBR

# CLAYSON Biçerdöver / Combine Harvester

## MOTOR ve MİL KEÇELERİ / Engine and Shaft Seals

SKT NO	KULLANILAN MODELLER Models	KULLANIM YERİ Place Of Use	ORJINAL NO 1 Original No 1	ORJINAL NO 1 Original No 2	EŞDEĞER NO 1 Equivalent No 1	EŞDEĞER NO 1 Equivalent No 2	ÖLÇÜLER MM. Dimensions-MM.					TİP Type	MALZEME Material
045151	Biçerdöver Combine Harvester	MİL KEÇESİ Shaft Seal	-		12010983		55,00	72,00	-	10,00	-	L3	NBR
047674	8040	MİL KEÇESİ Shaft Seal	-		12011187		55,00	80,00	-	10,00	-	L3TL	NBR
047479	8040-8055-8061	MİL KEÇESİ Shaft Seal	-		12000529		55,00	85,00	-	10,00	-	L3	NBR
047468-V	8040	MİL KEÇESİ Shaft Seal	-		12011000		60,00	85,00	-	10,00	-	L3L	FKM
047040	1530-1545	MİL KEÇESİ Shaft Seal	-		19031699		60,00	90,00	-	13,00	-	L3	NBR
047497	8040-8055-8061	MİL KEÇESİ Shaft Seal	-		12011199		70,00	90,00	-	10,00	12,00	L3LL	NBR
047544	1530-1545-8040	MİL KEÇESİ Shaft Seal	-		12011203		75,00	100,00	-	10,00	-	L3L	NBR
410107	8040	MİL KEÇESİ Shaft Seal	-		12013388		85,00	110,00	-	13,00	-	L3	NBR
412272	8040	MİL KEÇESİ Shaft Seal	-		12000552		100,00	130,00	-	13,00	-	L3TL	NBR
412018	1530-1545	MİL KEÇESİ Shaft Seal	-		-		102,00	130,00	-	13,00	-	L3	NBR

# DANA Transmisyon / Drivetrain Sys.

## AKS VE DİFERANSİYEL GRUBU / Axle and Drivetrain Group

SKT NO	KULLANILAN MODELLER Models	KULLANIM YERİ Place Of Use	ORJINAL NO 1 Orijinal No 1	ORJINAL NO 1 Orijinal No 2	EŞDEĞER NO 1 Equivalent No 1	EŞDEĞER NO 1 Equivalent No 2	ÖLÇÜLER MM. Dimensions-MM.					TİP Type	MALZEME Material
046201-NL	TRANSMİSYON SİST. Drivetrain System	ÖN AKS Front Axle	2110602001		12014977	993.460	45,00	60,00	-	16,00	-	KOMBI 1X	NBR+TPU
046280-NL	TRANSMİSYON SİST. Drivetrain System	ÖN AKS Front Axle	02120605101		12018616		50,00	65,00	-	18,00	-	KOMBI 1X	NBR+TPU
417128	TRANSMİSYON SİST. Drivetrain System	ÖN AKS Front Axle	000051785	3764634M1	12018035	12014283	150,00	180,00	-	14,50	16,00	SC6	NBR
420074	TRANSMİSYON SİST. Drivetrain System	ÖN AKS Front Axle	3429815M1		12015136		190,00	220,00	-	16,00	18,00	SC6	NBR
041252-NL	TRANSMİSYON SİST. Drivetrain System	ÖN AKS DİFERANSİYEL Front Axle-Differential	3428829M1		12013519	12018617	30,00	44,00	-	14,00	-	KOMBI 1X	NBR+TPU
046296-NKL	TRANSMİSYON SİST. Drivetrain System	ÖN AKS DİFERANSİYEL Front Axle-Differential	2750601701		12012566		45,00	62,00	-	16,00	-	KOMBI 4	NBR-TPU- YÜN
046298-NK	TRANSMİSYON SİST. Drivetrain System	ÖN AKS DİFERANSİYEL Front Axle-Differential	3019957X1	7290601201	12001886		40,00	55,00	-	10,00	-	KOMBI 3	NBR+YÜN
046202-NL	TRANSMİSYON SİST. Drivetrain System	ÖN AKS DİFERANSİYEL Front Axle-Differential	000051726		12012377		45,00	65,00	-	18,50	-	KOMBI 1X	NBR+TPU
046083	4x4 TRAKTÖR SERİSİ 4x4 Tractor Series	ÖN AKS DİFERANSİYEL Front Axle-Differential	3765528M1	3785500M1	12015392		45,00	70,00	-	14,50	17,00	SC6	NBR
046223-NL	4x4 TRAKTÖR SERİSİ 4x4 Tractor Series	ÖN AKS DİFERANSİYEL Front Axle-Differential	3428259M1		12014048		50,00	72,00	-	16,50	-	KOMBI 1X	NBR+TPU
047928-NK	TRANSMİSYON SİST. Drivetrain System	ÖN AKS DİFERANSİYEL Front Axle-Differential	7290600901		12013176		55,00	80,00	-	11,00	-	KOMBI 3	NBR+YÜN
047823-NL	TRANSMİSYON SİST. Drivetrain System	ÖN AKS DİFERANSİYEL Front Axle-Differential	3428942M1		12014159		55,00	82,00	-	16,50	-	KOMBI 1X	NBR+TPU
047930-PN	TRANSMİSYON SİST. Drivetrain System	ÖN AKS DİFERANSİYEL Front Axle-Differential	000051846 3764632M1	355140070 151846	12016445		56,00	80,00	-	13,00	14,50	SC6	ACM+NBR
047921	TRANSMİSYON SİST. Drivetrain System	ÖN AKS DİFERANSİYEL Front Axle-Differential	7700601201		12018177		62,00	78,00	81,00	10,00	13,80	SPSC	NBR
415220	TRANSMİSYON SİST. Drivetrain System	ÖN AKS DİFERANSİYEL Front Axle-Differential	000051787	000051870	12016448		130,00	160,00	-	14,50	16,00	SC6	NBR
417141-NK	TRANSMİSYON SİST. Drivetrain System	ÖN AKS DİFERANSİYEL Front Axle-Differential	1760600502	3019959X1	12001925		165,00	190,00	-	17,00	-	KOMBI 3	NBR+YÜN
417127	TRANSMİSYON SİST. Drivetrain System	ÖN AKS DİFERANSİYEL Front Axle-Differential	3429790M1	3429790M2	12015149		165,00	195,00	-	16,50	18,00	SC6	NBR
420069-NK	TRANSMİSYON SİST. Drivetrain System	ÖN AKS DİFERANSİYEL Front Axle-Differential	30199660X1	5133736	12001926		190,00	220,00	-	20,00	-	KOMBI 3	NBR+YÜN

# DANA Transmisyon / Drivetrain Sys.

## AKS VE DİFERANSİYEL GRUBU / Axle and Drivetrain Group

SKT NO	KULLANILAN MODELLER Models	KULLANIM YERİ Place Of Use	ORJINAL NO 1 Orijinal No 1	ORJINAL NO 1 Orijinal No 2	EŞDEĞER NO 1 Equivalent No 1	EŞDEĞER NO 1 Equivalent No 2	ÖLÇÜLER MM. Dimensions-MM.					TİP Type	MALZEME Material
047689	TRANSMİSYON SİST. Drivetrain System	DİFERANSİYEL SİSTEMİ Differential System	001033318		12011780		50,00	90,00	-	10,00	-	L3TL	NBR
047718	TRANSMİSYON SİST. Drivetrain System	DİFERANSİYEL SİSTEMİ Differential System	001030621		12011192		60,00	80,00	-	10,00	-	L3TL	NBR
047695	TRANSMİSYON SİST. Drivetrain System	DİFERANSİYEL SİSTEMİ Differential System	001031311	1441258X1	12011195		65,00	85,00	-	10,00	-	L3TL	NBR
047700	TRANSMİSYON SİST. Drivetrain System	DİFERANSİYEL SİSTEMİ Differential System	001030033		12011200	12011017	70,00	100,00	-	10,00	-	L3TL	NBR
047756	TRANSMİSYON SİST. Drivetrain System	DİFERANSİYEL SİSTEMİ Differential System	001030034		12011201		75,00	95,00	-	10,00	-	L13TL SS-RL	NBR
045226	TRANSMİSYON SİST. Drivetrain System	DİF.ÖN-MAHRUTİ Differential Front	973933M1	000051300	12011158		40,00	60,00	-	10,00	-	L3L	NBR
410518-NK	TRANSMİSYON SİST. Drivetrain System	ARKA AKS Rear Axle	7290601001		12001907		75,00	102,00	-	14,00	-	KOMBI 3	NBR+YÜN
0415219	TRANSMİSYON SİST. Drivetrain System	ARKA AKS KOVAN Rear Axle	001213211	1770600901	12016451		140,00	170,00	-	14,50	16,00	SC6	NBR
417117	TRANSMİSYON SİST. Drivetrain System	ARKA AKS Rear Axle	3429791M1	3015376X1	12015133		165,00	190,00	-	15,50	17,00	SC6	NBR
410485	TRANSMİSYON SİST. Drivetrain System	ARKA AKS DIŞ Rear Axle Outer	3699800M2	7700601001	12018598		73,02	102,00	-	15,60	-	SPSC2	NBR
045497	TRANSMİSYON SİST. Drivetrain System	AKS SİSTEMİ Axle System	001011349		12010924		38,00	52,00	-	7,00	-	L3	NBR
047456	TRANSMİSYON SİST. Drivetrain System	AKS SİSTEMİ Axle System	001030621		12011192	12010999 12015900	60,00	80,00	-	10,00	12,00	L3L	NBR

## ŞANZİMAN GRUBU / Gearbox Group

SKT NO	KULLANILAN MODELLER Models	KULLANIM YERİ Place Of Use	ORJINAL NO 1 Orijinal No 1	ORJINAL NO 1 Orijinal No 2	EŞDEĞER NO 1 Equivalent No 1	EŞDEĞER NO 1 Equivalent No 2	ÖLÇÜLER MM. Dimensions-MM.					TİP Type	MALZEME Material
047746-V	TRANSMİSYON SİST. Drivetrain System	ŞANZİMAN ÖN Gearbox Front	001033652		12015924	12014854	60,00	80,00	-	8,00	-	L3	FKM
045254	TRANSMİSYON SİST. Drivetrain System	ŞANZİMAN MİLİ Gearbox Shaft	000051742	001020022	12010914		35,00	62,00	-	10,00	-	L3	NBR
047712	TRANSMİSYON SİST. Drivetrain System	ŞANZİMAN MİLİ Gearbox Shaft	001030730		12011188		55,00	90,00	-	10,00	-	L3L	NBR
047229	TRANSMİSYON SİST. Drivetrain System	ŞANZİMAN MİLİ Gearbox Shaft	001010622		12014022		70,00	85,00	-	8,00	-	L3	NBR



## AKS VE DİFERANSİYEL GRUBU / Axle and Drivetrain Group

SKT NO	KULLANILAN MODELLER Models	KULLANIM YERİ Place Of Use	ORJINAL NO 1 Orijinal No 1	ORJINAL NO 1 Orijinal No 2	EŞDEĞER NO 1 Equivalent No 1	EŞDEĞER NO 1 Equivalent No 2	ÖLÇÜLER MM. Dimensions-MM.					TİP Type	MALZEME Material
045665	TRAKTÖR SERİSİ Tractor Series	ÖN AKS DİFERANSİYEL Front Axle-Differential	215200170	050202335	12011146		35,00	55,00	-	11,00	-	L3L	NBR
046296-NKL	TRAKTÖR SERİSİ Tractor Series	ÖN AKS DİFERANSİYEL Front Axle-Differential	215290850		12012566		45,00	62,00	-	16,00	-	KOMBI 4	NBR-TPU-YÜN
046202-NL	TRAKTÖR SERİSİ Tractor Series	ÖN AKS DİFERANSİYEL Front Axle-Differential	04388209	215291120	12012377		45,00	65,00	-	18,50	-	KOMBI 1X	NBR+TPU
046223-NL	4x4 TRAKTÖR SERİSİ 4x4 Tractor Series	ÖN AKS DİFERANSİYEL Front Axle-Differential	215291110		12014048		50,00	72,00	-	16,50	-	KOMBI 1X	NBR+TPU
047930-PN	TRAKTÖR SERİSİ Tractor Series	ÖN AKS DİFERANSİYEL Front Axle-Differential	215291130		12016445		56,00	80,00	-	13,00	14,50	SC6	ACM+NBR
047718	TRAKTÖR SERİSİ Tractor Series	DİFERANSİYEL SİSTEMİ Differential System	215202310		12011192		60,00	80,00	-	10,00	-	L3TL	NBR
047695	TRAKTÖR SERİSİ Tractor Series	DİFERANSİYEL SİSTEMİ Differential System	04434571	7700006256	12011195		65,00	85,00	-	10,00	-	L3TL	NBR
047756	TRAKTÖR SERİSİ Tractor Series	DİFERANSİYEL SİSTEMİ Differential System	215200390		12011201		75,00	95,00	-	10,00	-	L13TL SS-RL	NBR
450078-PK	TRAKTÖR SERİSİ Tractor Series	ÖN AKS Front Axle	21529069020		19033620		240,00	270,00	-	25,00	-	KOMBI 3	ACM+YÜN
410252	TRAKTÖR SERİSİ Tractor Series	ARKA AKS İÇ Rear Axle Inner	215200430		12011206	12011036	85,00	110,00	-	12,00	-	L3L	NBR
045944	TRAKTÖR SERİSİ Tractor Series	AKS SİSTEMİ Axle System	215290920		12011126	12010860	25,00	52,00	-	7,00	-	L3TL	NBR
047456	TRAKTÖR SERİSİ Tractor Series	AKS SİSTEMİ Axle System	215202310		12011192	12010999 12015900	60,00	80,00	-	10,00	12,00	L3L	NBR
047147	TRAKTÖR SERİSİ Tractor Series	AKS SİSTEMİ Axle System	01160816		01000368	19031212	75,00	100,00	-	13,00	-	L3	NBR
045226	TRAKTÖR SERİSİ Tractor Series	DİF.ÖN-MAHRUTİ Differential Front	025156	000051300	12011158		40,00	60,00	-	10,00	-	L3L	NBR

## ŞANZIMAN GRUBU / Gearbox Group

SKT NO	KULLANILAN MODELLER Models	KULLANIM YERİ Place Of Use	ORJINAL NO 1 Orijinal No 1	ORJINAL NO 1 Orijinal No 2	EŞDEĞER NO 1 Equivalent No 1	EŞDEĞER NO 1 Equivalent No 2	ÖLÇÜLER MM. Dimensions-MM.					TİP Type	MALZEME Material
041160	TRAKTÖR SERİSİ Tractor Series	ŞANZIMAN MİLİ Gearbox Shaft	215200060		12011114		20,00	30,00	-	7,00	-	L3	NBR
040713	TRAKTÖR SERİSİ Tractor Series	ŞANZIMAN MİLİ Gearbox Shaft	01172559		01026703		22,00	35,00	-	7,00	-	L3L	NBR
047229	TRAKTÖR SERİSİ Tractor Series	ŞANZIMAN MİLİ Gearbox Shaft	01173041		12014022		70,00	85,00	-	8,00	-	L3	NBR

## MOTOR GRUBU / Engine Group

SKT NO	KULLANILAN MODELLER Models	KULLANIM YERİ Place Of Use	ORJINAL NO 1 Original No 1	ORJINAL NO 2 Original No 2	EŞDEĞER NO 1 Equivalent No 1	EŞDEĞER NO 2 Equivalent No 2	ÖLÇÜLER MM. Dimensions-MM.					TİP Type	MALZEME Material
047558-V	DİZEL MOT. Diesel Motor	KRANK ÖN Crank Shaft Front	2418F436	2415361	12014981		60,33	79,62	-	9,52	11,11	L3L SAĞ -Right	FKM
415171-V	TRAKTÖR SERİSİ Tractor Series	KRANK ARKA Crank Shaft Rear	2418F475		12010753	15026903	133,35	158,94	159,16	11,11	13,00	L13TL SOL -Left	FKM
415137-V	TRAKTÖR SERİSİ Tractor Series	KRANK ARKA Crank Shaft Rear	2418F475		12010753	15026903	133,35	159,05	-	11,11	13,00	L3L SOL -Left	FKM
45-009-V	TRAKTÖR SERİSİ Perkins Type Engine	SUPAP Valve Stem Seal	736840M1	33817117 33817125	12016623	292610	9,45	14,25	16,61	10,69	14,27	L	FKM
040140	TRAKTÖR SERİSİ Tractor Series	YAĞ POMPASI Oil Pump	102390				20,00	30,00	-	7,00	-	L3	NBR

## AKS VE DİFERANSİYEL GRUBU / Axle and Drivetrain Group

SKT NO	KULLANILAN MODELLER Models	KULLANIM YERİ Place Of Use	ORJINAL NO 1 Original No 1	ORJINAL NO 2 Original No 2	EŞDEĞER NO 1 Equivalent No 1	EŞDEĞER NO 2 Equivalent No 2	ÖLÇÜLER MM. Dimensions-MM.					TİP Type	MALZEME Material
415220	TRAKTÖR SERİSİ Tractor Series	ÖN AKS Front Axle	103148		12016448		130,00	160,00	-	14,50	16,00	SC6	NBR
417127	TRAKTÖR SERİSİ Tractor Series	ÖN AKS Front Axle	HFA399293		12015150		165,00	195,00	-	16,50	18,00	SC6	NBR
046197-VN	4x4 TRAKTÖR SERİSİ 4x4 Tractor Series	DİFERANSİYEL SİSTEMİ Differential System	H3699802M2				44,40	63,75	-	17,50	18,70	SPSC2	FKM+NBR
047699	TRAKTÖR SERİSİ Tractor Series	ARKA AKS KOVAN Rear Axle	H3698907M1				69,85	92,25	92,15	14,27	-	SC4	NBR
047496	TRAKTÖR SERİSİ Tractor Series	ARKA AKS PORYA İÇ Rear Axle Inner	-		12017076		58,00	80,00	-	13,00	-	L1L	NBR
047489	TRAKTÖR SERİSİ Tractor Series	ARKA AKS PORYA İÇ Rear Axle Inner	H1860954M1	894782			60,33	85,85	-	23,81	-	L1X	NBR
410444	TRAKTÖR SERİSİ Tractor Series	ARKA AKS Rear Axle	1900030701790				85,00	115,00	-	15,00	-	SC6	NBR
040205	TRAKTÖR SERİSİ Tractor Series	AKS SİSTEMİ Axle System	102382				35,00	50,00	-	10,00	-	L3	NBR
4D-037	TRAKTÖR SERİSİ Tractor Series	ARKA AKS FREN MİLİ Rear Axle Brake Shaft	1337003401031	85999093 86576339			14,25	50,80	63,50	9,30	43,26	LS	NBR
041238-V	TRAKTÖR SERİSİ Tractor Series	MİL KEÇESİ Shaft Seal	5HT11000 A1A				25,00	33,00	-	4,00	4,70	L2TL	FKM

ŞANZIMAN GRUBU / Gearbox Group

SKT NO	KULLANILAN MODELLER Models	KULLANIM YERİ Place Of Use	ORJINAL NO 1 Original No 1	ORJINAL NO 2 Original No 2	EŞDEĞER NO 1 Equivalent No 1	EŞDEĞER NO 2 Equivalent No 2	ÖLÇÜLER MM. Dimensions-MM.					TİP Type	MALZEME Material
047846-P	TRAKTÖR SERİSİ Tractor Series	ŞANZIMAN ÖN Gearbox Front	102612				45,00	85,00	-	8,00	13,00	L3XT SAĞ -Right	ACM
040492	TRAKTÖR SERİSİ Tractor Series	ŞANZIMAN ÖN DIŞ Gearbox Front Outer	1860011M1				28,58	41,35	-	9,52	-	L1	NBR
045565	TRAKTÖR SERİSİ Tractor Series	ŞANZIMAN MİLİ Gearbox Shaft	H002.55.186				40,00	52,00	-	7,00	8,50	L3L	NBR
047712	TRAKTÖR SERİSİ Tractor Series	ŞANZ. İŞTİRAK DIŞLISI Gearbox - Overgear	KH3735		12011188		55,00	90,00	-	10,00	-	L3L	NBR
047820	TRAKTÖR SERİSİ Tractor Series	PTO KUYRUK MİLİ Power Take Off Shaft	H3699801M1				60,30	79,40	-	15,50	16,60	SPSC2	NBR
040745	TRAKTÖR SERİSİ Tractor Series	ŞANZIMAN MİLİ Gearbox Shaft	1557002401541		12011122		25,00	35,00	-	7,00	-	L3TL	NBR
045678-P	TRAKTÖR SERİSİ Tractor Series	PTO KUYRUK MİLİ Power Take Off Shaft	1900030744260				40,00	62,00	-	8,00	-	L3TL	ACM
045990-V	TRAKTÖR SERİSİ Tractor Series	ŞANZIMAN ÖN Gearbox Front	-				55,00	70,00	-	8,00	-	L13TL SAĞ -Right	FKM
046138-P	TRAKTÖR SERİSİ Tractor Series	PTO KUYRUK MİLİ Power Take Off Shaft	1900030701300				55,00	70,00	-	8,00	-	L3TL SAĞ -Right	ACM

DİĞER GRUPLAR / Others Group

SKT NO	KULLANILAN MODELLER Models	KULLANIM YERİ Place Of Use	ORJINAL NO 1 Original No 1	ORJINAL NO 2 Original No 2	EŞDEĞER NO 1 Equivalent No 1	EŞDEĞER NO 2 Equivalent No 2	ÖLÇÜLER MM. Dimensions-MM.					TİP Type	MALZEME Material
4U-299	TRAKTÖR SERİSİ Tractor Series	HİDROLİK SİSTEMİ Hydraulic System	1337007300621				55,00	75,00	-	10,00	6,50	UCL	NBR
4U-367-V	TRAKTÖR SERİSİ Tractor Series	HİDROLİK SİSTEMİ Hydraulic System	102559 288730102	1357007300391 288073001020			60,00	85,00	-	12,00	-	UIL	FKM
4MH-451	TRAKTÖR SERİSİ Tractor Series	HİDROLİK SİSTEMİ Hydraulic System	HFA200113				47,20	68,00	-	8,70	-	MH	NBR
40834	TRAKTÖR SERİSİ Tractor Series	HİDROLİK POMPA Hydraulic Pump	0.5P-100-020		12011512		10,00	22,00	-	6,00	-	L3BTL	NBR
40228	TRAKTÖR SERİSİ Tractor Series	HİD.KUMANDA SİSTEMİ Hydraulic Control System	H195908M1				25,40	31,85	-	3,17	-	L5	NBR

## MOTOR GRUBU / Engine Group

SKT NO	KULLANILAN MODELLER Models	KULLANIM YERİ Place Of Use	ORJINAL NO 1 Orijinal No 1	ORJINAL NO 2 Orijinal No 2	EŞDEĞER NO 1 Equivalent No 1	EŞDEĞER NO 2 Equivalent No 2	ÖLÇÜLER MM. Dimensions-MM.					TİP Type	MALZEME Material
412275-V	TRAKTÖR SERİSİ Tractor Series	KRANK ÖN Crank Shaft Front	X550170902000		01016267		105,00	130,00	-	11,00	-	L13L SAĞ -Right	FKM
412368-FP	TRAKTÖR SERİSİ Tractor Series	KRANK ARKA Crank Shaft Rear	824200210180		20029606		110,00	130,00	-	13,00	-	F25TL SOL -Left	PTFE+ACM
041174	TRAKTÖR SERİSİ Tractor Series	YAKIT POMPASI Fuel Pump	X550041202000		12011122	12010846	25,00	35,00	-	7,00	-	L3	NBR
040150	TRAKTÖR SERİSİ Tractor Series	SU POMPASI Water Pump	X550054801000		12010885		30,00	50,00	-	10,00	-	L3	NBR
045361	TRAKTÖR SERİSİ Tractor Series	SU POMPASI Water Pump	F184108100070		12010908		35,00	52,00	-	10,00	-	L3L	NBR

## AKS ve DİFERANSİYEL GRUBU / Axle and Differential Group

SKT NO	KULLANILAN MODELLER Models	KULLANIM YERİ Place Of Use	ORJINAL NO 1 Orijinal No 1	ORJINAL NO 2 Orijinal No 2	EŞDEĞER NO 1 Equivalent No 1	EŞDEĞER NO 2 Equivalent No 2	ÖLÇÜLER MM. Dimensions-MM.					TİP Type	MALZEME Material
417128	TRAKTÖR SERİSİ Tractor Series	ÖN AKS Front Axle	H524300020100		12018035	12014283	150,00	180,00	-	14,50	16,00	SC6	NBR
046202-NL	TRAKTÖR SERİSİ Tractor Series	ÖN AKS DİFERANSİYEL Front Axle-Differential	X550096901000		12012377		45,00	65,00	-	18,50	-	KOMBI 1X	NBR+TPU
047930-PN	TRAKTÖR SERİSİ Tractor Series	ÖN AKS DİFERANSİYEL Front Axle-Differential	H524300020110		12016445		56,00	80,00	-	13,00	14,50	SC6	ACM+NBR
045700	TRAKTÖR SERİSİ Tractor Series	DİFERANSİYEL SİSTEMİ Differential System	X553984809000	25A3660	12011160		40,00	62,00	-	10,00	-	L3L	NBR
047695	TRAKTÖR SERİSİ Tractor Series	DİFERANSİYEL SİSTEMİ Differential System	X550132901000	400001990	12013927		65,00	85,00	-	10,00	-	L3TL	NBR
047059	TRAKTÖR SERİSİ Tractor Series	ARKA AKS Rear Axle	X550150400000		12011026	12002284	80,00	100,00	-	10,00	-	L3	NBR
040278	TRAKTÖR SERİSİ Tractor Series	AKS SİSTEMİ Axle System	X550035200000		01034676		22,00	35,00	-	7,00	-	L3	NBR
045731	TRAKTÖR SERİSİ Tractor Series	AKS SİSTEMİ Axle System	X550108904000		12011174		50,00	65,00	-	8,00	-	L1L	NBR

## ŞANZIMAN GRUBU / Gearbox Group

SKT NO	KULLANILAN MODELLER Models	KULLANIM YERİ Place Of Use	ORJINAL NO 1 Orijinal No 1	ORJINAL NO 1 Orijinal No 2	EŞDEĞER NO 1 Equivalent No 1	EŞDEĞER NO 1 Equivalent No 2	ÖLÇÜLER MM. Dimensions-MM.					TİP Type	MALZEME Material
040713	TRAKTÖR SERİSİ Tractor Series	ŞANZIMAN MİLİ Gearbox Shaft	X550035100000		01034676		22,00	35,00	-	7,00	-	L3L	NBR
040745	TRAKTÖR SERİSİ Tractor Series	ŞANZIMAN MİLİ Gearbox Shaft	X550041202000		12011122		25,00	35,00	-	7,00	-	L3TL	NBR
040287	TRAKTÖR SERİSİ Tractor Series	ŞANZIMAN MİLİ-TURNER Gearbox Shaft - Turner Type	X550215709000		19026533		32,00	45,00	-	7,00	-	L3	NBR
047889-V	TRAKTÖR SERİSİ Tractor Series	ŞANZIMAN MİLİ Gearbox Shaft	X550133204000				65,00	90,00	-	10,00	-	L3L SAĞ -Right	FKM

## DİĞER GRUPLAR / Others Group

SKT NO	KULLANILAN MODELLER Models	KULLANIM YERİ Place Of Use	ORJINAL NO 1 Orijinal No 1	ORJINAL NO 1 Orijinal No 2	EŞDEĞER NO 1 Equivalent No 1	EŞDEĞER NO 1 Equivalent No 2	ÖLÇÜLER MM. Dimensions-MM.					TİP Type	MALZEME Material
040651	TRAKTÖR SERİSİ Tractor Series	HİDROLİK POMPA Hydraulic Pump	X551011209000		12011120		22,00	40,00	-	7,00	-	L3L	NBR
045822	TRAKTÖR SERİSİ Tractor Series	HİD. KALDIRMA SİSTEMİ Hydraulic Lifting System	X550222502000	90300700035	01002633		55,00	70,00	-	8,00	-	L3L	NBR

## MOTOR GRUBU / Engine Group

SKT NO	KULLANILAN MODELLER Models	KULLANIM YERİ Place Of Use	ORJINAL NO 1 Original No 1	ORJINAL NO 2 Original No 2	EŞDEĞER NO 1 Equivalent No 1	EŞDEĞER NO 2 Equivalent No 2	ÖLÇÜLER MM. Dimensions-MM.					TİP Type	MALZEME Material
047363	2000-3000-3600-3610-5000-6600-6610	KRANK ÖN Crank Shaft Front	C5NN6700A				60,33	82,75	-	12,70	-	L6L	NBR
047255	MAJOR-SUPER MAJOR	KRANK ÖN Crank Shaft Front	504E6362 3639011M1	831482M1 81710683			66,67	89,10	-	12,70	-	L3L	NBR
047255-S	MAJOR-SUPER MAJOR	KRANK ÖN Crank Shaft Front	E88GF9				66,67	89,10	-	12,70	-	L3L	VMQ
412233-S	2000-3000-3600-3610-500-6000-6610	KRANK ARKA Crank Shaft Rear	C5NE6701C2	E5NN6701BA			122,23	141,12	-	11,90	-	L3 SOL-Left	VMQ
412233-V	2000-3000-3600-3610-500-6000-6610	KRANK ARKA Crank Shaft Rear	C5NE6701C2	E5NN6701BA	15017000	15011274	122,23	141,12	-	11,90	-	L3 SOL-Left	FKM
045037	DEXTA 2000	EKSANTRİK MİLİ Cam Shaft	957E6362				50,80	69,95	-	12,70	-	SL	NBR
040257	MAJOR-SUPER MAJOR	YAKIT POMPASI Fuel Pump	502E993207				17,00	34,00	-	4,00	-	L3	NBR
040146	MAJOR-SUPER MAJOR	YAKIT POMPASI Fuel Pump	E1ADDN993207				20,00	35,00	-	7,00	-	L3	NBR
040506	2000-3000-3600-3610	YAKIT POMPASI Fuel Pump	770080457				20,00	35,00	-	8,00	-	L3X	NBR
040506-V	2000-3000 -3600-3610	YAKIT POMPASI Fuel Pump	770080457				20,00	35,00	-	8,00	-	L3X	FKM
040149	DEXTA 2000	YAKIT POMPASI Fuel Pump	E1ADDN993207	40002590 7251406	12011487		25,00	35,00	-	7,00	-	L3	NBR
409	2000-3000-5000-6600-6610-47 HP	SU POMPASI Water Pump	C3AE8564A	83914016			15,87	36,60	42,86	7,54	19,05	K010	NBR
427	2000-3000 47 HP	SU POMPASI Water Pump	1446130M1	825374M1			15,87	42,86	-	19,05	-	K012	NBR
045361	TRAKTÖR SERİSİ Tractor Series	SU POMPASI Water Pump	0280145		12010908		35,00	52,00	-	10,00	-	L3L	NBR
045573	2000-3000 47 HP	SU POMPASI Water Pump	957E750A				44,45	73,20	-	12,70	-	L3	NBR
047458	5000-6000-6610	SU POMPASI Water Pump	C5NNP788A				47,62	76,37	-	12,70	-	L3	NBR
047326	2000-3000-3600-3610-5000-6600-6610	SU POMPASI Water Pump	C5NNP785A				57,15	85,90	-	12,70	-	L3	NBR

**AKS ve DİFERANSİYEL GRUBU / Axle and Differential Group**

SKT NO	KULLANILAN MODELLER Models	KULLANIM YERİ Place Of Use	ORJINAL NO 1 Orijinal No 1	ORJINAL NO 2 Orijinal No 2	EŞDEĞER NO 1 Equivalent No 1	EŞDEĞER NO 2 Equivalent No 2	ÖLÇÜLER MM. Dimensions-MM.					TİP Type	MALZEME Material
045468	2000-3000-3600-3610	ÖN AKS Front Axle	957E1190A				42,86	68,17	-	9,52	-	CL3	NBR
047565	3600-3610-5000-6600-6610	ÖN AKS Front Axle	C5NN1190A	D8NN1190CA E0NN1190AA			52,12	74,67	-	8,35	-	CSPL5L	NBR
047238	MAJOR-SUPER MAJOR	ÖN AKS Front Axle	8T4676B				70,00	100,00	-	10,00	-	L3	NBR
045283	DEXTA 2000	ARKA AKS Rear Axle	957E4233A				53,98	73,27	-	9,52	-	L3	NBR
410127	DEXTA 2000	ARKA AKS Rear Axle	957E4250A				79,38	101,80	-	12,70	-	L4	NBR
410152	MAJOR-SUPER MAJOR	ARKA AKS Rear Axle	E27N4245A	81717525			79,38	114,52	-	12,70	-	L3	NBR
415173	5000 -6000-6610	ARKA AKS Rear Axle	C5NN4969C				88,90	152,20	155,00	14,28	35,71	SPL1L	NBR
047364	2000-3000-3600-3610	ARKA AKS DIŞ Rear Axle Outer	C5NN4115A	C5NN4233A C9NN4N109A			79,38	98,58	-	12,70	-	L3	NBR
045469	2000-3000-3600-3611	ARKA AKS PORYA İÇ Rear Axle Inner	C5NN4233A	C5NN4115B			52,39	70,00	-	12,70	-	L3	NBR
4D-037	2000-3000-3600-3610-5000- 6600-6610	ARKA AKS FREN MİLİ Rear Axle Brake Shaft	C5NN2N336A	82037652			14,25	50,80	63,50	9,30	43,26	LS	NBR
040562	2000-3000-3600-3610-6000- 6610	FREN SİSTEMİ Brake System	D9NN- 2N289AA	83924047- C5NN2N258C			28,58	39,95	-	7,93	-	L3L	NBR
040211	MAJOR-SUPER MAJOR	FREN SİSTEMİ Brake System	E27N2867A	81717372			28,58	44,52	-	11,11	-	L3	NBR
040047	MAJOR-SUPER MAJOR	FREN SİSTEMİ Brake System	E27N2867A 81803055	90003074316			35,00	47,00	-	7,00	-	L3	NBR
040290	DEXTA 2000	FREN SİSTEMİ Brake System	E44LA9	5085590	12010923		38,00	50,00	-	7,00	-	L3	NBR
047494-P	D 1210-1313	DİF.ÖN-MAHRUTİ Differential Front	504E6362	EIANKN6362B	-	-	66,67	89,03	-	12,70	-	L1L	ACM
040406	5000-6600-6610	DİFERANSİYEL KİLİDİ Differential Locking Sys.	C5NN2N602A				15,87	22,32	-	3,17	-	L5	NBR

## ŞANZIMAN GRUBU / Gearbox Group

SKT NO	KULLANILAN MODELLER Models	KULLANIM YERİ Place Of Use	ORJINAL NO 1 Original No 1	ORJINAL NO 1 Original No 2	EŞDEĞER NO 1 Equivalent No 1	EŞDEĞER NO 1 Equivalent No 2	ÖLÇÜLER MM. Dimensions-MM.					TİP Type	MALZEME Material
040737	3600-3610 37 HP	ŞANZIMAN ÖN Gearbox Front	883935M1				28,58	38,17	-	6,35	-	L1	NBR
045396	2000-3000-3600-3610-5000	ŞANZIMAN ÖN Gearbox Front	E81GD9	D9NN7R- 510BA			28,58	55,75	-	12,70	-	L3	NBR
047322	5000-6600-6610	ŞANZIMAN ÖN Gearbox Front	C5NN77047A	D9N- N7048AA/BA			58,73	79,58	-	9,52	-	L3	NBR
047354	TRAKTÖR SERİSİ Tractor Series	ŞANZIMAN ÖN Gearbox Front	D6NN7N838A				66,67	92,15	-	11,11	-	SLL	NBR
045397	2000-3000-3600-3610-5000	ŞANZIMAN ARKA Gearbox Rear	E62GE9				42,86	73,25	-	15,87	-	L3X	NBR
046002	2000-3000-3600-3610-5000-6600- 6610	SANZIMAN ALT KAPAK Gearbox Lower Cap	C5NN77086A				39,69	60,50	-	12,70	-	L3X	NBR
040174	5000-6600-6610 SERİ	ŞANZIMAN MİLİ Gearbox Shaft	C5NN799A	81801990			30,00	40,00	-	7,00	-	L3	NBR
045525	3600-3610-5000-6600-6610	PTO KUYRUK MİLİ Power Take Off Shaft	XN606422	D9NNN710A			38,10	63,65	-	7,93	-	L1L	NBR
045319	3600-3610-5000-6600-6610-MAJOR	PTO KUYRUK MİLİ Power Take Off Shaft	E27N7305A 81819064	C5NNN710B D9NNN710B			38,10	63,65	-	12,70	-	SL	NBR
045572	2000-3000 47 HP-DEXTA 2000	PTO KUYRUK MİLİ Power Take Off Shaft	C5NN9N703A	9N703B D9NN703BA			41,28	62,10	-	15,87	-	SLL	NBR
040463	5000-6600-6610 SERİSİ	DİREKSİYON SİSTEMİ Steering System	D5NN3N632A				20,64	35,10	-	12,70	-	L3L	NBR

## DİĞER GRUPLAR / Others Group

SKT NO	KULLANILAN MODELLER Models	KULLANIM YERİ Place Of Use	ORJINAL NO 1 Original No 1	ORJINAL NO 1 Original No 2	EŞDEĞER NO 1 Equivalent No 1	EŞDEĞER NO 1 Equivalent No 2	ÖLÇÜLER MM. Dimensions-MM.					TİP Type	MALZEME Material
040292	2000-3000 -3600-3610	DİREKSİYON SEKTÖR MİLİ Steering Sector Shaft	C5NN3C615A				28,98	36,60	-	3,96	-	L1	NBR
045400	5000 77 HP	DİREKSİYON SEKTÖR MİLİ Steering Sector Shaft	C5NN3C615B	9038			38,89	50,80	-	6,35	-	L3	NBR
040490	2000-3000 -3600-3610-5000- 6000	HİDROLİK POMPA Hydraulic Pump	1P2.100.020	D2NN3N529A			17,46	28,75	-	7,93	-	L3X	NBR
045414	2000-3000-5000-6600-6610	HİDROLİK POMPA Hydraulic Pump	C5NN851A				25,40	50,90	-	13,49	-	SLX	NBR



## AKS ve DİFERANSİYEL GRUBU / Axle and Differential Group

SKT NO	KULLANILAN MODELLER Models	KULLANIM YERİ Place Of Use	ORJINAL NO 1 Orijinal No 1	ORJINAL NO 1 Orijinal No 2	EŞDEĞER NO 1 Equivalent No 1	EŞDEĞER NO 1 Equivalent No 2	ÖLÇÜLER MM. Dimensions-MM.					TİP Type	MALZEME Material
047928-NK	BAHÇE TRAKTÖRÜ Equal Size Wheel Tractors	ÖN AKS DİFERANSİYEL Front Axle-Differential	06220125		12013176		55,00	80,00	-	11,00	-	KOMBI 3	NBR+YÜN
047896-NK	BAHÇE TRAKTÖRÜ Equal Size Wheel Tractors	ÖN AKS DİFERANSİYEL Front Axle-Differential	06220108	83957804	12001903		65,00	92,00	-	14,00	-	KOMBI 3	NBR+YÜN
410518-NK	BAHÇE TRAKTÖRÜ Equal Size Wheel Tractors	ARKA AKS Rear Axle	06220174		12001907		75,00	102,00	-	14,00	-	KOMBI 3	NBR+YÜN
041165	BAHÇE TRAKTÖRÜ Equal Size Wheel Tractors	AKS SİSTEMİ Axle System	06220046		12010858		25,00	47,00	-	7,00	-	L3TL	NBR
045944	BAHÇE TRAKTÖRÜ Equal Size Wheel Tractors	AKS SİSTEMİ Axle System	06220127		12011126	12010860	25,00	52,00	-	7,00	-	L3TL	NBR
045700	BAHÇE TRAKTÖRÜ Equal Size Wheel Tractors	DİFERANSİYEL SİSTEMİ Differential System	06220147		12011160		40,00	62,00	-	10,00	-	L3L	NBR
045779	BAHÇE TRAKTÖRÜ Equal Size Wheel Tractors	DİFERANSİYEL SİSTEMİ Differential System	6220054		12011168		45,00	65,00	-	10,00	-	L3L	NBR
045934	BAHÇE TRAKTÖRÜ Equal Size Wheel Tractors	DİFERANSİYEL SİSTEMİ Differential System	06220140		12011177		50,00	72,00	-	7,00	-	L3BTL	NBR
047883	BAHÇE TRAKTÖRÜ Equal Size Wheel Tractors	DİFERANSİYEL SİSTEMİ Differential System	06220004		12011196		65,00	90,00	-	10,00	-	L3L	NBR
040717	BAHÇE TRAKTÖRÜ Equal Size Wheel Tractors	MİL KEÇESİ Shaft Seal	06220190		12011112		17,00	28,00	-	7,00	-	L3L	NBR
040180	BAHÇE TRAKTÖRÜ Equal Size Wheel Tractors	MİL KEÇESİ Shaft Seal	06220011		12011118		20,00	40,00	-	7,00	-	L3	NBR
040183	BAHÇE TRAKTÖRÜ Equal Size Wheel Tractors	MİL KEÇESİ Shaft Seal	06220013		12010828		20,00	42,00	-	10,00	-	L3	NBR
040167	BAHÇE TRAKTÖRÜ Equal Size Wheel Tractors	MİL KEÇESİ Shaft Seal	06220020		12016917		25,00	38,00	-	7,00	-	L3	NBR
040144	BAHÇE TRAKTÖRÜ Equal Size Wheel Tractors	MİL KEÇESİ Shaft Seal	06220021		12010859		25,00	47,00	-	10,00	-	L3	NBR
045916	BAHÇE TRAKTÖRÜ Equal Size Wheel Tractors	MİL KEÇESİ Shaft Seal	06220082		12000485		30,00	55,00	-	7,00	-	L3T	NBR
045214	BAHÇE TRAKTÖRÜ Equal Size Wheel Tractors	MİL KEÇESİ Shaft Seal	06220036		12010909		35,00	55,00	-	10,00	-	L3	NBR
045227	BAHÇE TRAKTÖRÜ Equal Size Wheel Tractors	MİL KEÇESİ Shaft Seal	06220057		12010962		48,00	62,00	-	8,00	-	L3	NBR
047575	BAHÇE TRAKTÖRÜ Equal Size Wheel Tractors	MİL KEÇESİ Shaft Seal	06220117		12010985		55,00	80,00	-	8,00	-	L3	NBR
047101	BAHÇE TRAKTÖRÜ Equal Size Wheel Tractors	MİL KEÇESİ Shaft Seal	06220075		12010988		55,00	90,00	-	10,00	-	L3	NBR

## ŞANZIMAN GRUBU / Gearbox Group

SKT NO	KULLANILAN MODELLER Models	KULLANIM YERİ Place Of Use	ORJINAL NO 1 Orijinal No 1	ORJINAL NO 1 Orijinal No 2	EŞDEĞER NO 1 Equivalent No 1	EŞDEĞER NO 1 Equivalent No 2	ÖLÇÜLER MM. Dimensions-MM.					TİP Type	MALZEME Material
040591	BAHÇE TRAKTÖRÜ Equal Size Wheel Tractors	ŞANZIMAN MİLİ Gearbox Shaft	06220111		12011111		16,00	28,00	-	7,00	-	L3L	NBR
040756	BAHÇE TRAKTÖRÜ Equal Size Wheel Tractors	ŞANZIMAN MİLİ Gearbox Shaft	06220068		12011130		28,00	47,00	-	7,00	-	L3L	NBR
040761	BAHÇE TRAKTÖRÜ Equal Size Wheel Tractors	ŞANZIMAN MİLİ Gearbox Shaft	06220068		12000480		30,00	47,00	-	7,00	-	L3TL	NBR
045946	BAHÇE TRAKTÖRÜ Equal Size Wheel Tractors	ŞANZIMAN MİLİ Gearbox Shaft	6220096		12011137		30,00	62,00	-	7,00	-	L3TL	NBR
045254	BAHÇE TRAKTÖRÜ Equal Size Wheel Tractors	ŞANZIMAN MİLİ Gearbox Shaft	06220037		12010914		35,00	62,00	-	10,00	-	L3	NBR
040862	BAHÇE TRAKTÖRÜ Equal Size Wheel Tractors	DİREKSİYON MİLİ Steering Shaft	06220009		12010825		20,00	35,00	-	7,00	-	L3TL	NBR

## DİREKSİYON GRUBU / Steering Group

SKT NO	KULLANILAN MODELLER Models	KULLANIM YERİ Place Of Use	ORJINAL NO 1 Orijinal No 1	ORJINAL NO 1 Orijinal No 2	EŞDEĞER NO 1 Equivalent No 1	EŞDEĞER NO 1 Equivalent No 2	ÖLÇÜLER MM. Dimensions-MM.					TİP Type	MALZEME Material
040862	BAHÇE TRAKTÖRÜ Equal Size Wheel Tractors	DİREKSİYON MİLİ Steering Shaft	06220009		12010825		20,00	35,00	-	7,00	-	L3TL	NBR

## AKS ve DİFERANSİYEL GRUBU / Axle and Differential Group

SKT NO	KULLANILAN MODELLER Models	KULLANIM YERİ Place Of Use	ORJINAL NO 1 Orijinal No 1	ORJINAL NO 2 Orijinal No 2	EŞDEĞER NO 1 Equivalent No 1	EŞDEĞER NO 2 Equivalent No 2	ÖLÇÜLER MM. Dimensions-MM.					TİP Type	MALZEME Material
046128-NK	TRANSMİSYON SİST. Drivetrain System	ÖN AKS Front Axle	70631		12012503		50,00	75,00	-	12,00	-	KOMBI 3	NBR+YÜN
415212	TRANSMİSYON SİST. Drivetrain System	ÖN AKS Front Axle	3292083		12017098		127,00	160,00	-	15,50	17,50	SC6	NBR
410405	TRANSMİSYON SİST. Drivetrain System	ARKA AKS Rear Axle	3472100333		12001908		80,00	110,00	-	16,00	-	KOMBI 3	NBR+TPU
415219-V	TRANSMİSYON SİST. Drivetrain System	ARKA AKS Rear Axle	71526		12016451		140,00	170,00	-	14,50	16,00	SC6	FKM
045329	TRANSMİSYON SİST. Drivetrain System	AKS SİSTEMİ Axle System	3447210022		12014807		35,00	68,00	-	10,00	-	L3	NBR
410052	TRANSMİSYON SİST. Drivetrain System	AKS SİSTEMİ Axle System	70267		12000542		75,00	110,00	-	12,00	-	L3	NBR
045329	TRANSMİSYON SİST. Drivetrain System	ARKA AKS FREN MİLİ Rear Axle Brake Shaft	35959853	595985 548274	12011496		35,00	55,00	-	10,00	-	L1	NBR
415220	TRANSMİSYON SİST. Drivetrain System	ÖN AKS DİFERANSİYEL Front Axle-Differential	71563		12016448		130,00	160,00	-	14,50	16,00	SC6	NBR
045700	TRANSMİSYON SİST. Drivetrain System	DİFERANSİYEL SİSTEMİ Differential System	351360023		12011160		40,00	62,00	-	10,00	-	L3L	NBR
047689	TRANSMİSYON SİST. Drivetrain System	DİFERANSİYEL SİSTEMİ Differential System	3472100053		12011780		50,00	90,00	-	10,00	-	L3TL	NBR
047746	TRANSMİSYON SİST. Drivetrain System	DİFERANSİYEL SİSTEMİ Differential System	71354		12010998		60,00	80,00	-	8,00	-	L3	NBR
047700	TRANSMİSYON SİST. Drivetrain System	DİFERANSİYEL SİSTEMİ Differential System	70735		12011200	12011017	70,00	100,00	-	10,00	-	L3TL	NBR

## ŞANZİMAN GRUBU / Gearbox Group

SKT NO	KULLANILAN MODELLER Models	KULLANIM YERİ Place Of Use	ORJINAL NO 1 Orijinal No 1	ORJINAL NO 2 Orijinal No 2	EŞDEĞER NO 1 Equivalent No 1	EŞDEĞER NO 2 Equivalent No 2	ÖLÇÜLER MM. Dimensions-MM.					TİP Type	MALZEME Material
040745	TRANSMİSYON SİST. Drivetrain System	ŞANZİMAN MİLİ Gearbox Shaft	72019		12011122		25,00	35,00	-	7,00	-	L3TL	NBR
040765	TRANSMİSYON SİST. Drivetrain System	ŞANZİMAN MİLİ Gearbox Shaft	71143		12011131		30,00	40,00	-	7,00	-	L3L	NBR
047816-P	TRANSMİSYON SİST. Drivetrain System	ŞANZİMAN MİLİ Gearbox Shaft	71135	5119203	12000733		55,00	80,00	-	10,00	8,00	L3L	ACM

## MOTOR GRUBU / Engine Group

SKT NO	KULLANILAN MODELLER Models	KULLANIM YERİ Place Of Use	ORJINAL NO 1 Original No 1	ORJINAL NO 1 Original No 2	EŞDEĞER NO 1 Equivalent No 1	EŞDEĞER NO 1 Equivalent No 2	ÖLÇÜLER MM. Dimensions-MM.					TİP Type	MALZEME Material
045537-S	TRAKTÖR SERİSİ Tractor Series	KRANK ÖN Crank Shaft Front	H002.01.299		12011460	12013479	42,00	65,00	-	12,00	-	L1L SAĞ -Right	VMQ
047588-V	MF 135-240	KRANK ÖN Crank Shaft Front	1447689M1	2415344	12014982		57,15	76,45	-	9,52	11,11	L3L SAĞ -Right	FKM
047558-V	MF 165-240-285	KRANK ÖN Crank Shaft Front	2418F436	1447690M1 2415361	12014981		60,33	79,62	-	9,52	-	L3L SAĞ -Right	FKM
047894-V	MF 165-240-285	KRANK ÖN Crank Shaft Front	1447690M1	2418F437	12014981	578.010	60,33	79,63	-	9,33	11,23	L3TL SAĞ -Right	FKM
410219-S	TRAKTÖR SERİSİ Tractor Series	KRANK ARKA Crank Shaft Rear	H002.01.199		12011314		95,00	120,00	-	13,00	-	L1L SOL -Left	VMQ
410219-V	TRAKTÖR SERİSİ Tractor Series	KRANK ARKA Crank Shaft Rear	H002.01.199		12011314		95,00	120,00	-	13,00	-	L1L SOL -Left	FKM
420056-VAE	HATTAT A90-A100-A110	KRANK ARKA Crank Shaft Rear	2418F701	4224532M1	20031744		133,30	197,00	219,00	24,00	-	SPL1L SOL -Left	FKM+AEM
040140	TRAKTÖR SERİSİ Tractor Series	YAĞ POMPASI Oil Pump	H1442907X1				20,00	30,00	-	7,00	-	L3	NBR
041174	TRAKTÖR SERİSİ Tractor Series	YAKIT POMPASI Fuel Pump	KH0156		12011122	12010846	25,00	35,00	-	7,00	-	L3	NBR

## AKS ve DİFERANSİYEL GRUBU / Axle and Differential Group

SKT NO	KULLANILAN MODELLER Models	KULLANIM YERİ Place Of Use	ORJINAL NO 1 Original No 1	ORJINAL NO 1 Original No 2	EŞDEĞER NO 1 Equivalent No 1	EŞDEĞER NO 1 Equivalent No 2	ÖLÇÜLER MM. Dimensions-MM.					TİP Type	MALZEME Material
046281	TRAKTÖR SERİSİ Tractor Series	ÖN AKS Front Axle	HFA200116		-		47,00	75,00	-	14,00	17,00	SC7	NBR
046143	A70-A80 4x4 SERİ	ÖN AKS Front Axle	HFA200074	02332000	01002211		48,00	68,00	-	10,00	-	L3L	NBR
047490	TRAKTÖR SERİSİ Tractor Series	ÖN AKS Front Axle	1000084T1				60,33	85,90	-	12,70	-	L3	NBR
047505	TRAKTÖR SERİSİ Tractor Series	ÖN AKS Front Axle	H002.30.147				70,00	100,00	-	15,00	-	CL3L	NBR
046142-NL	TRAKTÖR SERİSİ Tractor Series	ÖN AKS DİFERANSİYEL Front Axle-Differential	HFA100072	6000104667	12013465		40,00	60,00	-	18,50	-	KOMBI 1X	NBR+TPU
046082-NL	TRAKTÖR SERİSİ Tractor Series	ÖN AKS DİFERANSİYEL Front Axle-Differential	HFA399206	7600100501	12018030		45,00	65,00	-	25,00	-	KOMBI 2X	NBR+TPU

## AKS ve DİFERANSİYEL GRUBU / Axle and Differential Group

SKT NO	KULLANILAN MODELLER Models	KULLANIM YERİ Place Of Use	ORJINAL NO 1 Orijinal No 1	ORJINAL NO 2 Orijinal No 2	EŞDEĞER NO 1 Equivalent No 1	EŞDEĞER NO 2 Equivalent No 2	ÖLÇÜLER MM. Dimensions-MM.					TİP Type	MALZEME Material
046083	4x4 TRAKTÖR SERİSİ 4x4 Tractor Series	ÖN AKS DİFERANSİYEL Front Axle-Differential	HFA399290		12015392		45,00	70,00	-	14,00	17,00	SC6	NBR
4MH-417-L	TRAKTÖR SERİSİ Tractor Series	ÖN AKS DİFERANSİYEL Front Axle-Differential	HFA399314	3429317M1			46,00	64,29	-	6,00	-	L	TPU
046040-P	TRAKTÖR SERİSİ Tractor Series	DİF.ÖN-MAHRUTİ Differential Front	HDB200110				30,00	62,00	-	10,00	-	SL	ACM
047494-P	TRAKTÖR SERİSİ Tractor Series	DİF.ÖN-MAHRUTİ Differential Front	E65055		-	-	66,67	89,03	-	12,70	-	L1L	ACM
046140-V	TRAKTÖR SERİSİ Tractor Series	DİFERANSİYEL SİSTEMİ Differential System	P9445000191				38,10	50,86	-	6,50	-	L1L	FKM
046141-PL	TRAKTÖR SERİSİ Tractor Series	DİFERANSİYEL SİSTEMİ Differential System	HFA100116		12015734		47,00	65,00	-	16,50	-	KOMBI 1X	ACM+TPU
047702-V	TRAKTÖR SERİSİ Tractor Series	ARKA AKS Rear Axle	H002.30.146				80,00	92,00	-	5,00	-	L1L	FKM
410445	TRAKTÖR SERİSİ Tractor Series	ARKA AKS Rear Axle	R36423				82,60	107,92	-	9,50	-	L1L	NBR
410485	TRAKTÖR SERİSİ Tractor Series	ARKA AKS DIŞ Rear Axle Outer	3699800M2	369980M2	12018598		73,02	102,00	-	15,60	-	SPSC2	NBR
410332	TRAKTÖR SERİSİ Tractor Series	ARKA AKS PORYA İÇ Rear Axle Inner	H002.25.180		12011029		80,00	110,00	-	12,00	-	L3L	NBR
047456	TRAKTÖR SERİSİ Tractor Series	MİL KEÇESİ Shaft Seal	HTA102091		12011192	12010999 12015900	60,00	80,00	-	10,00	12,00	L3L	NBR
047847	TRAKTÖR SERİSİ Tractor Series	MİL KEÇESİ Shaft Seal	KH1182		12011195		65,00	85,00	-	10,00	-	L3L	NBR
412356	TRAKTÖR SERİSİ Tractor Series	MİL KEÇESİ Shaft Seal	HAA070137				100,00	129,85	-	12,50	14,00	SC6	NBR
412196	TRAKTÖR SERİSİ Tractor Series	MİL KEÇESİ Shaft Seal	H002.55.182		12011364		110,00	130,00	-	13,00	-	L1L	NBR
412197	TRAKTÖR SERİSİ Tractor Series	MİL KEÇESİ Shaft Seal	H002.25.181				110,00	150,00	-	13,00	-	L3	NBR
046013	TRAKTÖR SERİSİ Tractor Series	KARDAN MİLİ Propeller Shaft	H00255180	3079500680			40,00	62,00	-	10,00	-	SPL3L	NBR

## ŞANZIMAN GRUBU / Gearbox Group

SKT NO	KULLANILAN MODELLER Models	KULLANIM YERİ Place Of Use	ORJINAL NO 1 Original No 1	ORJINAL NO 2 Original No 2	EŞDEĞER NO 1 Equivalent No 1	EŞDEĞER NO 2 Equivalent No 2	ÖLÇÜLER MM. Dimensions-MM.					TİP Type	MALZEME Material
040737	TRAKTÖR SERİSİ Tractor Series	ŞANZIMAN ÖN Gearbox Front	H883935M4				28,58	38,17	-	6,35	-	L1	NBR
045606-P	TRAKTÖR SERİSİ Tractor Series	ŞANZIMAN ÖN Gearbox Front	X10889				39,69	60,50	-	9,52	-	L3	ACM
040484	TRAKTÖR SERİSİ Tractor Series	ŞANZIMAN ÖN 8 VİTES Gearbox Front - 8 Gear	H1860867M5	1860867M1			41,15	49,42	-	6,35	-	L1L	NBR
047552-P	TRAKTÖR SERİSİ Tractor Series	ŞANZIMAN ARKA Gearbox Rear	P25160		-	-	63,50	82,75	-	12,70	-	L3L SOL -Left	ACM
046151	A90-A100-A110	ŞANZIMAN ARA MİL Gearbox Intermediate Shaft	KH0193				45,00	60,00	-	8,00	-	L3	NBR
045739-P	TRAKTÖR SERİSİ Tractor Series	ŞANZIMAN-GÜÇ AKT. MİLİ Power Transfer Shaft	H003.17.199				45,00	65,00	-	10,00	12,00	L1L	ACM
047848	TRAKTÖR SERİSİ Tractor Series	ŞANZIMAN MİLİ Gearbox Shaft	KH1400				72,00	95,00	-	10,00	-	L3L	NBR
4TP-021	TRAKTÖR SERİSİ Tractor Series	ŞANZIMAN TAPASI Gearbox Plug	H3761376M1				-	35,40	-	6,75	-	T3T	NBR
041160	TRAKTÖR SERİSİ Tractor Series	ŞANZIMAN MİLİ Gearbox Shaft	KH0143		12011114		20,00	30,00	-	7,00	-	L3	NBR
040625	TRAKTÖR SERİSİ Tractor Series	ŞANZIMAN MİLİ Gearbox Shaft	HD200152				22,00	35,00	-	8,00	-	L12L	NBR
041170	TRAKTÖR SERİSİ Tractor Series	ŞANZIMAN MİLİ Gearbox Shaft	KH1057	5HT11000A1A			25,00	33,00	-	4,00	-	L2T	NBR
041175	TRAKTÖR SERİSİ Tractor Series	ŞANZIMAN MİLİ Gearbox Shaft	HTA102064				25,00	33,00	-	6,00	-	L3	NBR
045803-Z	TRAKTÖR SERİSİ Tractor Series	ŞANZIMAN MİLİ Gearbox Shaft	ADK100108				30,00	60,00	-	8,00	-	L3L	NBR
046152	TRAKTÖR SERİSİ Tractor Series	ŞANZIMAN MİLİ Gearbox Shaft	HTA102090				35,00	72,00	-	12,00	-	L3L	NBR
045565	TRAKTÖR SERİSİ Tractor Series	ŞANZIMAN MİLİ Gearbox Shaft	H002.55.186				40,00	52,00	-	7,00	8,50	L3L	NBR
046146	TRAKTÖR SERİSİ Tractor Series	ŞANZIMAN MİLİ Gearbox Shaft	ADK500106M	520005			40,00	55,00	-	6,00	-	L3BL	NBR
045269	TRAKTÖR SERİSİ Tractor Series	ŞANZIMAN MİLİ Gearbox Shaft	723002105000		12010938	12000504	40,00	65,00	-	10,00	-	L3	NBR
045492	TRAKTÖR SERİSİ Tractor Series	ŞANZIMAN MİLİ Gearbox Shaft	HDC40.977				48,00	62,00	-	10,00	-	L3	NBR

## ŞANZIMAN GRUBU / Gearbox Group

SKT NO	KULLANILAN MODELLER Models	KULLANIM YERİ Place Of Use	ORJINAL NO 1 Orijinal No 1	ORJINAL NO 2 Orijinal No 2	EŞDEĞER NO 1 Equivalent No 1	EŞDEĞER NO 2 Equivalent No 2	ÖLÇÜLER MM. Dimensions-MM.					TİP Type	MALZEME Material
047554-P	TRAKTÖR SERİSİ Tractor Series	ŞANZIMAN MİLİ Gearbox Shaft	X13072				53,98	76,40	-	9,52	-	L3L SOL -Left	ACM
047741-P	TRAKTÖR SERİSİ Tractor Series	ŞANZIMAN MİLİ Gearbox Shaft	-				55,00	80,00	-	8,00	12,00	L3TLR SAĞ -Right	ACM
047563-P	TRAKTÖR SERİSİ Tractor Series	ŞANZIMAN MİLİ Gearbox Shaft	X13702				66,67	95,50	-	11,90	-	L3L SOL -Left	ACM
047104	TRAKTÖR SERİSİ Tractor Series	ŞANZIMAN MİLİ Gearbox Shaft	723829056700				75,00	100,00	-	10,00	-	L3	NBR
041155	TRAKTÖR SERİSİ Tractor Series	PTO KUYRUK MİLİ Power Take Off Shaft	KH0106		12010758		8,00	22,00	-	7,00	-	L3	NBR
046139	TRAKTÖR SERİSİ Tractor Series	PTO KUYRUK MİLİ Power Take Off Shaft	KH1191		01031057		38,00	52,00	-	7,00	-	L3L	NBR
045832	TRAKTÖR SERİSİ Tractor Series	PTO KUYRUK MİLİ Power Take Off Shaft	9079500830		12014077		42,00	72,00	-	10,00	-	L3L	NBR
047467	TRAKTÖR SERİSİ Tractor Series	PTO KUYRUK MİLİ Power Take Off Shaft	H834216M1				60,33	79,47	-	9,92	-	L1L	NBR
040459	TRAKTÖR SERİSİ Tractor Series	DEBRİYAJ SİSTEMİ Clutch System	KH0159				25,00	47,00	-	7,00	-	L3	NBR

## DİREKSİYON GRUBU / Steering Group

SKT NO	KULLANILAN MODELLER Models	KULLANIM YERİ Place Of Use	ORJINAL NO 1 Original No 1	ORJINAL NO 1 Original No 2	EŞDEĞER NO 1 Equivalent No 1	EŞDEĞER NO 1 Equivalent No 2	ÖLÇÜLER MM. Dimensions-MM.					TİP Type	MALZEME Material
045926-V	TRAKTÖR SERİSİ Tractor Series	DİREKSİYON MİLİ Steering Shaft	EPP075003		01001689		35,00	52,00	-	6,00	-	L3BTL	FKM
040957-V	TRAKTÖR SERİSİ Tractor Series	HİD.DİREKSİYON POMPASI Power Steering Pump	01P100.052				13,45	26,97	-	7,00	-	L13BL	FKM
040655-P	TRAKTÖR SERİSİ Tractor Series	HİD.DİREKSİYON POMPASI Power Steering Pump	1P2.100.429	E97GF9			17,46	28,75	-	6,35	-	L3	ACM
041172-V	TRAKTÖR SERİSİ Tractor Series	HİD.DİREKSİYON POMPASI Power Steering Pump	0770198091				20,00	40,00	-	8,00	-	L3X	FKM
041186	TRAKTÖR SERİSİ Tractor Series	HİD.DİREKSİYON POMPASI Power Steering Pump	0770198134		01020066		26,00	34,00	-	4,50	7,00	SPL3BL	NBR
040743	TRAKTÖR SERİSİ Tractor Series	HİD.DİREKSİYON POMPASI Power Steering Pump	770198103				26,00	37,00	-	7,00	8,00	L3BTL	NBR
041093	TRAKTÖR SERİSİ Tractor Series	HİDROLİK DİREKSİYON-ZF Hydraulic Steering - ZF type	0770198101				17,00	28,00	-	6,50	-	L13X	NBR
041097	TRAKTÖR SERİSİ Tractor Series	HİDROLİK DİREKSİYON-ZF Hydraulic Steering - ZF type	0770198070		12010859		25,00	47,00	-	10,00	-	L3L	NBR

## DİĞER GRUPLAR / Others Group

SKT NO	KULLANILAN MODELLER Models	KULLANIM YERİ Place Of Use	ORJINAL NO 1 Original No 1	ORJINAL NO 1 Original No 2	EŞDEĞER NO 1 Equivalent No 1	EŞDEĞER NO 1 Equivalent No 2	ÖLÇÜLER MM. Dimensions-MM.					TİP Type	MALZEME Material
4MH-451	TRAKTÖR SERİSİ Tractor Series	HİDROLİK SİSTEMİ Hydraulic System	HFA200113				47,20	68,00	-	8,70	-	MH	NBR
040834	TRAKTÖR SERİSİ Tractor Series	HİDROLİK POMPA Hydraulic Pump	0.5P100.020		12011512		10,00	22,00	-	6,00	-	L3BTL	NBR
041093-V	TRAKTÖR SERİSİ Tractor Series	HİDROLİK POMPA Hydraulic Pump	770080228				17,00	28,00	-	6,50	-	L13X	FKM
041194-V	TRAKTÖR SERİSİ Tractor Series	HİDROLİK POMPA Hydraulic Pump	1PN.100.754				17,38	28,50	-	7,93	-	L3X	FKM



## DİĞER GRUPLAR / Others Group

SKT NO	KULLANILAN MODELLER Models	KULLANIM YERİ Place Of Use	ORJINAL NO 1 Orijinal No 1	ORJINAL NO 2 Orijinal No 2	EŞDEĞER NO 1 Equivalent No 1	EŞDEĞER NO 2 Equivalent No 2	ÖLÇÜLER MM. Dimensions-MM.					TİP Type	MALZEME Material
040490	TRAKTÖR SERİSİ Tractor Series	HİDROLİK POMPA Hydraulic Pump	1P2.100.020				17,46	28,75	-	7,93	-	L3X	NBR
040466	TRAKTÖR SERİSİ Tractor Series	HİDROLİK POMPA Hydraulic Pump	1P1.100.020	5110478 90350950			17,46	30,25	-	7,93	-	L1BL	NBR
040466-V	TRAKTÖR SERİSİ Tractor Series	HİDROLİK POMPA Hydraulic Pump	1P1.100.951				17,46	30,25	-	7,93	-	L1BL	FKM
041195	TRAKTÖR SERİSİ Tractor Series	HİDROLİK POMPA Hydraulic Pump	1MD.100.024				17,50	30,16	-	7,00	-	L3B	NBR
041195-V	TRAKTÖR SERİSİ Tractor Series	HİDROLİK POMPA Hydraulic Pump	1MD.100.025				17,50	30,16	-	7,00	-	L3B	FKM
040524	TRAKTÖR SERİSİ Tractor Series	HİDROLİK POMPA Hydraulic Pump	2P1.3000.030				20,00	30,00	-	8,00	-	L1X	NBR
041183-V	TRAKTÖR SERİSİ Tractor Series	HİDROLİK POMPA Hydraulic Pump	2P1.3000.325				22,15	38,00	-	6,00	7,50	L3BTL	FKM
040537	TRAKTÖR SERİSİ Tractor Series	HİDROLİK POMPA Hydraulic Pump	2P1.3000.020	2P13000020			22,22	38,17	-	9,52	-	L1BL	NBR
041157-V	TRAKTÖR SERİSİ Tractor Series	HİDROLİK POMPA Hydraulic Pump	P9115000101				25,40	38,10	-	6,50	-	L12L	FKM
041156-V	TRAKTÖR SERİSİ Tractor Series	HİDROLİK POMPA Hydraulic Pump	P9445000101				31,75	44,45	-	6,50	-	L12L	FKM
040654	TRAKTÖR SERİSİ Tractor Series	HİDROLİK POMPA Hydraulic Pump	3P1.4000.020				31,75	44,65	-	7,00	7,50	L13BL	NBR
040654-V	TRAKTÖR SERİSİ Tractor Series	HİDROLİK POMPA-1P1-2P1- 3P1-Hydraulic Pump	3P1-40000-20		-	-	31,75	44,65	-	7,00	7,50	L13BL	FKM
045278	TRAKTÖR SERİSİ Tractor Series	HİDROLİK POMPA Hydraulic Pump	HDC40.476		12011148	01002839	35,00	62,00	-	12,00	-	L3	NBR
041163-V	TRAKTÖR SERİSİ Tractor Series	HİDROLİK POMPA Hydraulic Pump	YP080015				27,00	35,00	-	6,70	-	L2B	FKM

## MOTOR GRUBU / Engine Group

SKT NO	KULLANILAN MODELLER Models	KULLANIM YERİ Place Of Use	ORJINAL NO 1 Orijinal No 1	ORJINAL NO 1 Orijinal No 2	EŞDEĞER NO 1 Equivalent No 1	EŞDEĞER NO 1 Equivalent No 2	ÖLÇÜLER MM. Dimensions-MM.					TİP Type	MALZEME Material
047558-V	İŞ MAKİNASI Backhoe-Loaders./ Cons. Equip.	KRANK ÖN Crank Shaft Front	02/101435		12014981	578.010	60,33	79,62	-	9,52	11,11	L3L SAĞ -Right	FKM
047894-V	İŞ MAKİNASI Backhoe-Loaders./ Cons. Equip.	KRANK ÖN Crank Shaft Front	2101435		12014981	578.010	60,33	79,63	-	9,33	11,23	L3TL SAĞ -Right	FKM
410482-FP	İŞ MAKİNASI Backhoe-Loaders./ Cons. Equip.	KRANK ÖN Crank Shaft Front	32003119	320/03119			85,00	111,13	-	15,24	-	SCF8 SAĞ -Right	PTFE+ACM
412376-FP	İŞ MAKİNASI Backhoe-Loaders./ Cons. Equip.	KRANK ARKA Crank Shaft Rear	32003029	320/03029			122,00	140,00	-	12,00	-	SPF4L SOL -Left	PTFE+ACM
415171-V	İŞ MAKİNASI Backhoe-Loaders./ Cons. Equip.	KRANK ARKA Crank Shaft Rear	2418F475	02/101436	12010753	15026903	133,35	158,94	159,16	11,11	13,00	L13TL SOL -Left	FKM
415137-V	İŞ MAKİNASI Backhoe-Loaders./ Cons. Equip.	KRANK ARKA Crank Shaft Rear	2418F475	02/101436	12010753	15026903	133,35	159,05	-	11,11	-	L3L SOL -Left	FKM
420056-VAE	İŞ MAKİNASI Backhoe-Loaders./ Cons. Equip.	KRANK ARKA Crank Shaft Rear	02/202935	2418F704	20031744	P77470-01	133,30	197,00	219,00	24,00	-	SPL1L SOL -Left	FKM+AEM

## AKS ve DİFERANSİYEL GRUBU / Axle and Differential Group

SKT NO	KULLANILAN MODELLER Models	KULLANIM YERİ Place Of Use	ORJINAL NO 1 Orijinal No 1	ORJINAL NO 1 Orijinal No 2	EŞDEĞER NO 1 Equivalent No 1	EŞDEĞER NO 1 Equivalent No 2	ÖLÇÜLER MM. Dimensions-MM.					TİP Type	MALZEME Material
047922-VN	İŞ MAKİNASI Backhoe-Loaders./ Cons. Equip.	ÖN AKS Front Axle	S0642387		12018849		65,00	92,00	-	10,00	15,00	SC6	FKM+NBR
415212	İŞ MAKİNASI Backhoe-Loaders./ Cons. Equip.	ÖN AKS Front Axle	904/50033 904/50025	90450033 90450025	12017098		127,00	160,00	-	15,50	17,50	SC6	NBR
046107-NL	İŞ MAKİNASI Backhoe-Loaders./ Cons. Equip.	ÖN AKS DİFERANSİYEL Front Axle-Differential	90450009	904/50009	12001894		45,00	65,00	-	15,00	-	KOMBI 4	NBR+TPU
046202-NL	İŞ MAKİNASI Backhoe-Loaders./ Cons. Equip.	ÖN AKS DİFERANSİYEL Front Axle-Differential	90450047	904/50047	12012377		45,00	65,00	-	18,50	-	KOMBI 1X	NBR+TPU
047825-NL	İŞ MAKİNASI Backhoe-Loaders./ Cons. Equip.	ÖN AKS DİFERANSİYEL Front Axle-Differential	904500060	904500040	12016669		46,15	80,00	-	16,50	-	KOMBI 1X	NBR+TPU
410404-NL	İŞ MAKİNASI Backhoe-Loaders./ Cons. Equip.	ÖN AKS DİFERANSİYEL Front Axle-Differential	90450008	904/50008	12001910		90,00	120,00	-	13,00	-	KOMBI 3	NBR+TPU
47674	İŞ MAKİNASI Backhoe-Loaders./ Cons. Equip.	DİFERANSİYEL SİSTEMİ Differential System	90420172 90450023	904/20172 904/50023	12015749 12011187	1029598	55,00	80,00	-	10,00	-	L3TL	NBR
47890	İŞ MAKİNASI Backhoe-Loaders./ Cons. Equip.	DİFERANSİYEL SİSTEMİ Differential System	90405100	904/05100	15026518		55,00	90,00	-	8,00	16,00	SPL3TLR SS-RL	NBR

## MOTOR GRUBU / Engine Group

SKT NO	KULLANILAN MODELLER Models	KULLANIM YERİ Place Of Use	ORJINAL NO 1 Orijinal No 1	ORJINAL NO 2 Orijinal No 2	EŞDEĞER NO 1 Equivalent No 1	EŞDEĞER NO 2 Equivalent No 2	ÖLÇÜLER MM. Dimensions-MM.					TİP Type	MALZEME Material
410241-S	444 SERİSİ	KRANK ARKA Crank Shaft Rear	1099317R91	3072092R91	-	-	92,08	111,28	-	11,11	-	L6 SOL -Left	VMQ
045610-P	444	EKSANTRİK MİLİ Cam Shaft	3108650R91		-	-	47,62	73,27	-	15,08	-	L3 SAĞ -Right	ACM
4S-005-P	330-1380 D358 MOT.	SUPAP Valve Stem Seal			-	-	10,00	14,00	17,50	7,80	11,90	LY	ACM

## AKS ve DİFERANSİYEL GRUBU / Axle and Differential Group

SKT NO	KULLANILAN MODELLER Models	KULLANIM YERİ Place Of Use	ORJINAL NO 1 Orijinal No 1	ORJINAL NO 2 Orijinal No 2	EŞDEĞER NO 1 Equivalent No 1	EŞDEĞER NO 2 Equivalent No 2	ÖLÇÜLER MM. Dimensions-MM.					TİP Type	MALZEME Material
045576	444	ÖN AKS Front Axle	3042600R91		-	-	44,35	72,23	-	11,90	-	CSL	NBR
045352	TRAKTÖR SERİSİ Tractor Series	ÖN AKS Front Axle	3058107R91	3058107R92	-	-	46,00	65,00	-	13,00	-	SLL	NBR
047301	TRAKTÖR SERİSİ Tractor Series	ÖN AKS Front Axle	3058106R91		-	-	62,00	80,00	-	16,00	-	SLL	NBR
47486	444	ARKA AKS Rear Axle	40031509	703917R92	-	-	65,08	85,75	-	12,70	-	L12	NBR
047357	TRAKTÖR SERİSİ Tractor Series	ARKA AKS Rear Axle	33021504		-	-	70,00	84,00	-	10,00	-	SL	NBR
412168	654 S	ARKA AKS Rear Axle	3145061R91	3145061R92 11190762	-	-	90,00	130,00	-	13,00	-	L1L	NBR
045601	444	DİF.ÖN-MAHRUTİ Differential Front	703908R92		-	-	41,28	62,15	-	12,70	-	L3	NBR

## ŞANZİMAN GRUBU / Gearbox Group

SKT NO	KULLANILAN MODELLER Models	KULLANIM YERİ Place Of Use	ORJINAL NO 1 Orijinal No 1	ORJINAL NO 2 Orijinal No 2	EŞDEĞER NO 1 Equivalent No 1	EŞDEĞER NO 2 Equivalent No 2	ÖLÇÜLER MM. Dimensions-MM.					TİP Type	MALZEME Material
040326	TRAKTÖR SERİSİ Tractor Series	ŞANZİMAN MİLİ Gearbox Shaft	-		-	-	15,87	28,35	-	7,93	9,92	L3L	NBR
045603-NK	444	PTO KUYRUK MİLİ Power Take Off Shaft	3065217R91		-	-	34,92	57,25	-	17,46	-	SL1K	NBR+YÜN
040478	444 SERİSİ	KONTROL LEVYESİ Control Lever	751513-R91		-	-	15,87	28,65	-	9,12	-	L1X	NBR

## MOTOR GRUBU / Engine Group

SKT NO	KULLANILAN MODELLER Models	KULLANIM YERİ Place Of Use	ORJINAL NO 1 Orijinal No 1	ORJINAL NO 1 Orijinal No 2	EŞDEĞER NO 1 Equivalent No 1	EŞDEĞER NO 1 Equivalent No 2	ÖLÇÜLER MM. Dimensions-MM.					TİP Type	MALZEME Material
047588-V	PERKİNS MOTOR Perkins Type Motor	KRANK ÖN Crank Shaft Front	02130051		12014982		57,15	76,45	-	9,52	11,11	L3L SAĞ -Right	FKM
047558-V	PERKİNS MOTOR Perkins Type Motor	KRANK ÖN Crank Shaft Front	02101435	7701031630	12014981		60,33	79,62	-	9,52	11,11	L3L SAĞ -Right	FKM
047894-V	PERKİNS MOTOR Perkins Type Motor	KRANK ÖN Crank Shaft Front	02101435	7701031630	12014981	578.010	60,33	79,63	-	9,33	11,23	L3TL SAĞ -Right	FKM
410482-FP	2CX-3CX-4CX	KRANK ÖN Crank Shaft Front	32003119				85,00	111,13	-	15,24	-	SCF8 SAĞ -Right	PTFE+ACM
412376-FP	2CX-3CX-4CX	KRANK ARKA Crank Shaft Rear	32003029				122,00	140,00	-	12,00	-	SPF4L SOL -Left	PTFE+ACM
415171-V	PERKİNS MOTOR Perkins Type Motor	KRANK ARKA Crank Shaft Rear	02101436		12010753	15026903	133,35	158,94	159,16	11,11	13,00	L13TL SOL -Left	FKM
415137-V	PERKİNS MOTOR Perkins Type Motor	KRANK ARKA Crank Shaft Rear	02101436		12010753	15026903	133,35	159,05	-	11,11	13,00	L3L SOL -Left	FKM
45-009-V	PERKİNS MOTOR Perkins Type Motor	SUPAP Valve Stem Seal	736840M1	3637041M1 33817119	12016623	292610	9,45	14,25	16,61	10,69	14,27	L	FKM

## ŞANZİMAN GRUBU / Gearbox Group

SKT NO	KULLANILAN MODELLER Models	KULLANIM YERİ Place Of Use	ORJINAL NO 1 Orijinal No 1	ORJINAL NO 1 Orijinal No 2	EŞDEĞER NO 1 Equivalent No 1	EŞDEĞER NO 1 Equivalent No 2	ÖLÇÜLER MM. Dimensions-MM.					TİP Type	MALZEME Material
047674	İŞ MAKİNASI Backhoe-Loaders./ Cons. Equip.	ŞANZİMAN MİLİ Gearbox Shaft	90450001	90450023	01029598	12015749	55,00	80,00	-	10,00	-	L3TL	NBR
410365	İŞ MAKİNASI Backhoe-Loaders./ Cons. Equip.	ŞANZİMAN MİLİ Gearbox Shaft	90420254		12015607		90,00	110,00	-	7,50	-	L3BTL	NBR
045355	İŞ MAKİNASI Backhoe-Loaders./ Cons. Equip.	MİL KEÇESİ Shaft Seal	90414800		12011191		60,00	75,00	-	8,00	-	L3	NBR
412098	İŞ MAKİNASI Backhoe-Loaders./ Cons. Equip.	MİL KEÇESİ Shaft Seal	90407700		19032823		110,00	140,00	-	13,00	-	L3	NBR
412375	JS460	MİL KEÇESİ Shaft Seal	20950972		12011827	12011074	120,00	150,00	-	12,00	-	L3L	NBR

AKS ve DİFERANSİYEL GRUBU / Axle and Differential Group

SKT NO	KULLANILAN MODELLER Models	KULLANIM YERİ Place Of Use	ORJINAL NO 1 Orijinal No 1	ORJINAL NO 2 Orijinal No 2	EŞDEĞER NO 1 Equivalent No 1	EŞDEĞER NO 2 Equivalent No 2	ÖLÇÜLER MM. Dimensions-MM.					TİP Type	MALZEME Material
415212	İŞ MAKİNASI Backhoe-Loaders./ Cons. Equip.	ÖN AKS Front Axle	90450025	90450033	12017098		127,00	160,00	-	15,50	17,50	SC6	NBR
417128	İŞ MAKİNASI Backhoe-Loaders./ Cons. Equip.	ÖN AKS Front Axle	47701	AL159594 RE204870	12018035	12014283	150,00	180,00	-	14,50	16,00	SC6	NBR
041252-NL	İŞ MAKİNASI Backhoe-Loaders./ Cons. Equip.	ÖN AKS DİFERANSİYEL Front Axle-Differential	-		12013519	12018617	30,00	44,00	-	14,00	-	KOMBI 1X	NBR+TPU
046199-NK	İŞ MAKİNASI Backhoe-Loaders./ Cons. Equip.	ÖN AKS DİFERANSİYEL Front Axle-Differential	5194291	116722 9968020	12001882		35,00	52,00	-	16,00	-	KOMBI 3	NBR-YÜN
046142-NL	İŞ MAKİNASI Backhoe-Loaders./ Cons. Equip.	ÖN AKS DİFERANSİYEL Front Axle-Differential	144105		12013464		40,00	60,00	-	18,50	-	KOMBI 1X	NBR+TPU
046107-NL	İŞ MAKİNASI Backhoe-Loaders./ Cons. Equip.	ÖN AKS DİFERANSİYEL Front Axle-Differential	90450009		12001894		45,00	65,00	-	15,00	-	KOMBI 4	NBR+TPU
046202-NL	İŞ MAKİNASI Backhoe-Loaders./ Cons. Equip.	ÖN AKS DİFERANSİYEL Front Axle-Differential	90450047		12012377		45,00	65,00	-	18,50	-	KOMBI 1X	NBR+TPU
047825-NL	3CX-4CX İŞ MAKİNASI	ÖN AKS DİFERANSİYEL Front Axle-Differential	904500060	904500040	12016669		46,15	80,00	-	16,50	-	KOMBI 1X	NBR+TPU
410404-NL	İŞ MAKİNASI Backhoe-Loaders./ Cons. Equip.	ÖN AKS DİFERANSİYEL Front Axle-Differential	90450008		12001910		90,00	120,00	-	13,00	-	KOMBI 3	NBR+TPU
045779	İŞ MAKİNASI Backhoe-Loaders./ Cons. Equip.	DİFERANSİYEL SİSTEMİ Differential System	90450003		12011168		45,00	65,00	-	10,00	-	L3L	NBR
047890	İŞ MAKİNASI Backhoe-Loaders./ Cons. Equip.	DİFERANSİYEL SİSTEMİ Differential System	90405100		15026518		55,00	90,00	-	8,00	16,00	SPL3TLR SS-RL	NBR
047883	İŞ MAKİNASI Backhoe-Loaders./ Cons. Equip.	DİFERANSİYEL SİSTEMİ Differential System	90407300		12011196		65,00	90,00	-	10,00	-	L3L	NBR
410265	İŞ MAKİNASI Backhoe-Loaders./ Cons. Equip.	DİFERANSİYEL SİSTEMİ Differential System	90414700		12011412		90,00	110,00	-	13,00	-	SLL	NBR
047674-V	3CX-3DX-4CX	ARKA AKS Rear Axle	90420172	215295140 128530	01033625		55,00	80,00	-	10,00	-	L3TL	FKM

## MOTOR GRUBU / Engine Group

SKT NO	KULLANILAN MODELLER Models	KULLANIM YERİ Place Of Use	ORJINAL NO 1 Orijinal No 1	ORJINAL NO 2 Orijinal No 2	EŞDEĞER NO 1 Equivalent No 1	EŞDEĞER NO 2 Equivalent No 2	ÖLÇÜLER MM. Dimensions-MM.					TİP Type	MALZEME Material
047481	TRAKTÖR SERİSİ Tractor Series	KRANK ÖN Crank Shaft Front	AT21608 2414111	185174M1 591448M1	-	-	57,15	76,32	-	9,52	-	L1L	NBR
047481-S	TRAKTÖR SERİSİ Tractor Series	KRANK ÖN Crank Shaft Front	AR67942	AT21608- AT21606			57,15	76,32	-	9,52	-	L1L	VMQ
412260-S	1020-1120-1520	KRANK ARKA Crank Shaft Rear	AT22965 RE24959	RE44574 RE524227	15042000		120,65	146,20	-	12,70	-	SLL	VMQ
412264-V	TRAKTÖR SERİSİ Tractor Series	KRANK ARKA Crank Shaft Rear	AR92893	RE44574	15042000		120,65	146,20	-	12,70	-	L1	FKM
4KIT-059	TRAKTÖR SERİSİ Tractor Series	KRANK ARKA TM. TK Crank Shaft Rear Rep. Kit.	AT22965	(412260-S+ 4D-094)			-	-	-	-	-	KIT	-
4KIT-061	TRAKTÖR SERİSİ Tractor Series	KRANK ARKA TM. TK. Crank Shaft Rear Rep. Kit.	RE11036-AR92893 RE537070	(412260-V+ 4D-094)			-	-	-	-	-	KIT	-
041174	TRAKTÖR SERİSİ Tractor Series	YAKIT POMPASI Fuel Pump	RE45889		12011122	12010846	25,00	35,00	-	7,00	-	L3	NBR

## AKS ve DİFERANSİYEL GRUBU / Axle and Differential Group

SKT NO	KULLANILAN MODELLER Models	KULLANIM YERİ Place Of Use	ORJINAL NO 1 Orijinal No 1	ORJINAL NO 2 Orijinal No 2	EŞDEĞER NO 1 Equivalent No 1	EŞDEĞER NO 2 Equivalent No 2	ÖLÇÜLER MM. Dimensions-MM.					TİP Type	MALZEME Material
046201-NL	TRAKTÖR SERİSİ Tractor Series	ÖN AKS Front Axle	ER144485	2110602001	12014977	993.460	45,00	60,00	-	16,00	-	KOMBI 1X	NBR+TPU
047509	TRAKTÖR SERİSİ Tractor Series	ÖN AKS Front Axle	AR26480				60,22	88,18	-	7,54	-	CSPL8L	NBR
047237	TRAKTÖR SERİSİ Tractor Series	ÖN AKS Front Axle	AL38356		12011003		62,00	85,00	-	10,00	-	L3	NBR
417132	4x4 TRAKTÖR SERİSİ 4x4 Tractor Series	ÖN AKS Front Axle	EQ501471	ER047705	12013126		150,00	176,00	-	15,50	16,00	SC6	NBR
417128	TRAKTÖR SERİSİ Tractor Series	ÖN AKS Front Axle	ER047702 RE195990	AL159594 L500786	12018035	12014283	150,00	180,00	-	14,50	16,00	SC6	NBR
046208-NK	4x4 TRAKTÖR SERİSİ 4x4 Tractor Series	ÖN AKS İÇ Front Axle Inner	ER116723		12001889		42,00	62,00	-	14,00	-	KOMBI 3	NBR+YÜN
041331-NK	TRAKTÖR SERİSİ Tractor Series	ÖN AKS DİFERANSİYEL Front Axle-Differential	ER118516		12001879		30,00	44,00	-	11,00	-	KOMBI 3	NBR+YÜN
041252-NL	TRAKTÖR SERİSİ Tractor Series	ÖN AKS DİFERANSİYEL Front Axle-Differential	ER126398		12013519	12018617	30,00	44,00	-	14,00	-	KOMBI 1X	NBR+TPU

## AKS ve DİFERANSİYEL GRUBU / Axle and Differential Group

SKT NO	KULLANILAN MODELLER Models	KULLANIM YERİ Place Of Use	ORJINAL NO 1 Original No 1	ORJINAL NO 2 Original No 2	EŞDEĞER NO 1 Equivalent No 1	EŞDEĞER NO 2 Equivalent No 2	ÖLÇÜLER MM. Dimensions-MM.					TİP Type	MALZEME Material
046300-NK	TRAKTÖR SERİSİ Tractor Series	ÖN AKS DİFERANSİYEL Front Axle-Differential	ER123208		12011969		45,00	65,00	-	12,00	-	KOMBI 3	NBR+YÜN
047920-NL	TRAKTÖR SERİSİ Tractor Series	ÖN AKS DİFERANSİYEL Front Axle-Differential	ER118899	RE195989	12001902		58,00	82,00	-	15,00	-	KOMBI 1X	NBR+TPU
047920-VL	TRAKTÖR SERİSİ Tractor Series	ÖN AKS DİFERANSİYEL Front Axle-Differential	ER139420	RE195989	12017237		58,00	82,00	-	16,00	-	KOMBI 1X	FKM+TPU
047930-PN	TRAKTÖR SERİSİ Tractor Series	ÖN AKS DİFERANSİYEL Front Axle-Differential	AL161384		12016445		56,00	80,00	-	13,00	14,50	SC6	ACM+NBR
415220	TRAKTÖR SERİSİ Tractor Series	ÖN AKS DİFERANSİYEL Front Axle-Differential	ER047700	R113984	12016448		130,00	160,00	-	14,50	16,00	SC6	NBR
046297-NL	TRAKTÖR SERİSİ Tractor Series	DİFERANSİYEL SİSTEMİ Differential System	RE195987		12016507		42,00	62,00	-	21,50	-	KOMBI 1X	NBR-TPU
045779	TRAKTÖR SERİSİ Tractor Series	DİFERANSİYEL SİSTEMİ Differential System	RE282386		12011168		45,00	65,00	-	10,00	-	L3L	NBR
047883	TRAKTÖR SERİSİ Tractor Series	DİFERANSİYEL SİSTEMİ Differential System	ER025278		12011196		65,00	90,00	-	10,00	-	L3L	NBR
410489-V	TRAKTÖR SERİSİ Tractor Series	DİF.ÖN-MAHRUTİ Differential Front	T218478		01029710		90,00	125,00	-	12,00	19,00	L3TLR SAĞ -Right	FKM
047163	TRAKTÖR SERİSİ Tractor Series	ARKA AKS Rear Axle	AT21693				61,91	85,21	-	11,90	-	SL	NBR
410257	TRAKTÖR SERİSİ Tractor Series	ARKA AKS Rear Axle	AT20703	SJ15582			76,07	117,48	-	9,52	-	CSPL8L	NBR
047059	TRAKTÖR SERİSİ Tractor Series	ARKA AKS Rear Axle	ER025315		12011026	01002942	80,00	100,00	-	10,00	-	L3	NBR
047431	TRAKTÖR SERİSİ Tractor Series	ARKA AKS PORYA İÇ Rear Axle Inner	AT20702	AL39391			57,15	76,45	-	9,52	-	L3	NBR
410252	TRAKTÖR SERİSİ Tractor Series	ARKA AKS İÇ Rear Axle Inner	48M7033	AL60978	12011206	12011036	85,00	110,00	-	12,00	-	L3L	NBR
040311	TRAKTÖR SERİSİ Tractor Series	AKS SİSTEMİ Axle System	ER025240		12010842		24,00	37,00	-	7,00	-	L3	NBR
047087	TRAKTÖR SERİSİ Tractor Series	AKS SİSTEMİ Axle System	ER025267		12010999	12011192	60,00	80,00	-	10,00	-	L3	NBR
40040	TRAKTÖR SERİSİ Tractor Series	FREN SİSTEMİ Brake System	T22101				22,22	28,65	-	4,76	-	L5	NBR

## ŞANZIMAN GRUBU / Gearbox Group

SKT NO	KULLANILAN MODELLER Models	KULLANIM YERİ Place Of Use	ORJINAL NO 1 Orijinal No 1	ORJINAL NO 1 Orijinal No 2	EŞDEĞER NO 1 Equivalent No 1	EŞDEĞER NO 1 Equivalent No 2	ÖLÇÜLER MM. Dimensions-MM.					TİP Type	MALZEME Material
040306	TRAKTÖR SERİSİ Tractor Series	ŞANZIMAN ÖN Gearbox Front	AT21780	AA28861	01031966		28,58	41,35	-	6,35	-	L1L	NBR
045754	TRAKTÖR SERİSİ Tractor Series	ŞANZIMAN ÖN Gearbox Front	T22198				41,28	54,22	-	7,93	-	L3B	NBR
047193	TRAKTÖR SERİSİ Tractor Series	ŞANZIMAN ARKA Gearbox Rear	AT16431	AL68619 RE13181			73,02	95,40	-	12,70	-	SL	NBR
041160	TRAKTÖR SERİSİ Tractor Series	ŞANZIMAN MİLİ Gearbox Shaft	ER025107		12011114		20,00	30,00	-	7,00	-	L3	NBR
040745	TRAKTÖR SERİSİ Tractor Series	ŞANZIMAN MİLİ Gearbox Shaft	RE45889	7251406	12011122		25,00	35,00	-	7,00	-	L3TL	NBR
040761	TRAKTÖR SERİSİ Tractor Series	ŞANZIMAN MİLİ Gearbox Shaft	RE275256		12000480		30,00	47,00	-	7,00	-	L3TL	NBR
045405	TRAKTÖR SERİSİ Tractor Series	ŞANZIMAN MİLİ Gearbox Shaft	ER025193		12010940		40,00	72,00	-	10,00	-	L3	NBR
047229	TRAKTÖR SERİSİ Tractor Series	ŞANZIMAN MİLİ Gearbox Shaft	ER025294		12014022		70,00	85,00	-	8,00	-	L3	NBR
045472	BİÇERDÖVER Combine Harvester	PTO KUYRUK MİLİ Power Take Off Shaft	T22069	AL56820 AH14076			34,92	54,08	-	9,52	-	SL	NBR
046139	TRAKTÖR SERİSİ Tractor Series	PTO KUYRUK MİLİ Power Take Off Shaft	48M7038	01172223	01031057	12013698	38,00	52,00	-	7,00	-	L3L	NBR
047478	TRAKTÖR SERİSİ Tractor Series	PTO KUYRUK MİLİ Power Take Off Shaft	AT16887	AT124396			66,67	92,15	-	9,52	-	L1L	NBR
047193-S	TRAKTÖR SERİSİ Tractor Series	PTO KUYRUK MİLİ Power Take Off Shaft	AT16431	AL68619 RE13181			73,02	95,40	-	12,70	-	SL	VMQ
410158	TRAKTÖR SERİSİ Tractor Series	PTO KUYRUK MİLİ Power Take Off Shaft	AR26706				87,31	114,55	-	12,70	-	L3	NBR



## DİĞER GRUPLAR / Others Group

SKT NO	KULLANILAN MODELLER Models	KULLANIM YERİ Place Of Use	ORJINAL NO 1 Orijinal No 1	ORJINAL NO 2 Orijinal No 2	EŞDEĞER NO 1 Equivalent No 1	EŞDEĞER NO 2 Equivalent No 2	ÖLÇÜLER MM. Dimensions-MM.					TİP Type	MALZEME Material
040380	TRAKTÖR SERİSİ Tractor Series	DİREKSİYON KUTUSU Steering Box	T22260				22,22	35,03	-	6,35	-	L12L	NBR
045114	TRAKTÖR SERİSİ Tractor Series	DİREKSİYON SEKTÖR MİLİ Steering Sector Shaft	AT11927	AL28553	01026397		44,45	57,25	-	7,93	-	SL	NBR
040490	TRAKTÖR SERİSİ Tractor Series	HİDROLİK POMPA Hydraulic Pump	AH15442				17,46	28,75	-	7,93	-	L3X	NBR
040378	TRAKTÖR SERİSİ Tractor Series	HİDROLİK POMPA Hydraulic Pump	AR39052	AT22639	01031908		25,40	38,17	-	6,35	-	L1L	NBR
040228	TRAKTÖR SERİSİ Tractor Series	HİD.KUMANDA SİSTEMİ Hydraulic Control System	AA5607R				25,40	31,85	-	3,17	-	L5	NBR

# LAMBORGHINI

## MOTOR GRUBU / Engine Group

SKT NO	KULLANILAN MODELLER Models	KULLANIM YERİ Place Of Use	ORJINAL NO 1 Original No 1	ORJINAL NO 2 Original No 2	EŞDEĞER NO 1 Equivalent No 1	EŞDEĞER NO 2 Equivalent No 2	ÖLÇÜLER MM. Dimensions-MM.					TİP Type	MALZEME Material
410403-V	TRAKTÖR SERİSİ Tractor Series	KRANK ARKA Crank Shaft Rear	04102866		12019078		105,00	125,00	-	12,00	9,50	L13TL SOL -Left	FKM
412189-S	TRAKTÖR SERİSİ Tractor Series	KRANK ARKA Crank Shaft Rear	215290730	3055310R91	12012521		110,00	130,00	-	13,00	-	L1L SOL -Left	VMQ
412189-V	TRAKTÖR SERİSİ Tractor Series	KRANK ARKA Crank Shaft Rear	215290730	123797	12012521		110,00	130,00	-	13,00	-	L1L SOL -Left	FKM

## AKS ve DİFERANSİYEL GRUBU / Axle and Differential Group

SKT NO	KULLANILAN MODELLER Models	KULLANIM YERİ Place Of Use	ORJINAL NO 1 Original No 1	ORJINAL NO 2 Original No 2	EŞDEĞER NO 1 Equivalent No 1	EŞDEĞER NO 2 Equivalent No 2	ÖLÇÜLER MM. Dimensions-MM.					TİP Type	MALZEME Material
047553	TRAKTÖR SERİSİ Tractor Series	ÖN AKS Front Axle	215290910		12000354		70,00	95,00	-	10,00	-	L3	NBR
450078-PK	TRAKTÖR SERİSİ Tractor Series	ÖN AKS Front Axle	21529069020		19033620		240,00	270,00	-	25,00	-	KOMBI 3	ACM+YÜN
045665	TRAKTÖR SERİSİ Tractor Series	ÖN AKS DİFERANSİYEL Front Axle-Differential	215200170	198636160	12011146		35,00	55,00	-	11,00	-	L3L	NBR
046296-NKL	TRAKTÖR SERİSİ Tractor Series	ÖN AKS DİFERANSİYEL Front Axle-Differential	215290780	215290850	12012566		45,00	62,00	-	16,00	-	KOMBI 4	NBR-TPU- YÜN
046202-NL	TRAKTÖR SERİSİ Tractor Series	ÖN AKS DİFERANSİYEL Front Axle-Differential	215291120		12012377		45,00	65,00	-	18,50	-	KOMBI 1X	NBR+TPU
047930-PN	TRAKTÖR SERİSİ Tractor Series	ÖN AKS DİFERANSİYEL Front Axle-Differential	215291130		12016445		56,00	80,00	-	13,00	14,50	SC6	ACM+NBR
045779	TRAKTÖR SERİSİ Tractor Series	DİFERANSİYEL SİSTEMİ Differential System	215201230		12011168		45,00	65,00	-	10,00	-	L3L	NBR
045229	TRAKTÖR SERİSİ Tractor Series	DİFERANSİYEL SİSTEMİ Differential System	215100460	215104260	12010971		50,00	72,00	-	10,00	-	L3	NBR
047718	TRAKTÖR SERİSİ Tractor Series	DİFERANSİYEL SİSTEMİ Differential System	215202310		12011192		60,00	80,00	-	10,00	-	L3TL	NBR
047756	TRAKTÖR SERİSİ Tractor Series	DİFERANSİYEL SİSTEMİ Differential System	215200390		12011201		75,00	95,00	-	10,00	-	L13TL SS -RL	NBR
410252	TRAKTÖR SERİSİ Tractor Series	ARKA AKS İÇ Rear Axle Inner	215200430	215295010	12011206	12011036	85,00	110,00	-	12,00	-	L3L	NBR
045226	TRAKTÖR SERİSİ Tractor Series	DİF.ÖN-MAHRUTİ Differential Front	215103170	000051300	12011158		40,00	60,00	-	10,00	-	L3L	NBR

## ŞANZIMAN GRUBU / Gearbox Group

SKT NO	KULLANILAN MODELLER Models	KULLANIM YERİ Place Of Use	ORJINAL NO 1 Orijinal No 1	ORJINAL NO 1 Orijinal No 2	EŞDEĞER NO 1 Equivalent No 1	EŞDEĞER NO 1 Equivalent No 2	ÖLÇÜLER MM. Dimensions-MM.					TİP Type	MALZEME Material
045609-P	TRAKTÖR SERİSİ Tractor Series	ŞANZIMAN ÖN Gearbox Front	215290290		12014056	19026746	45,00	62,00	-	10,00	-	L3 SAĞ -Right	ACM
041160	TRAKTÖR SERİSİ Tractor Series	ŞANZIMAN MİLİ Gearbox Shaft	215200060		12011114		20,00	30,00	-	7,00	-	L3	NBR
040713	TRAKTÖR SERİSİ Tractor Series	ŞANZIMAN MİLİ Gearbox Shaft	01172559		01026703		22,00	35,00	-	7,00	-	L3L	NBR
040765	TRAKTÖR SERİSİ Tractor Series	ŞANZIMAN MİLİ Gearbox Shaft	215295180		12011131		30,00	40,00	-	7,00	-	L3L	NBR
045254	TRAKTÖR SERİSİ Tractor Series	ŞANZIMAN MİLİ Gearbox Shaft	215106170		12010914		35,00	62,00	-	10,00	-	L3	NBR
047229	TRAKTÖR SERİSİ Tractor Series	ŞANZIMAN MİLİ Gearbox Shaft	215100360		12014022		70,00	85,00	-	8,00	-	L3	NBR

## DİĞER GRUPLAR / Others Group

SKT NO	KULLANILAN MODELLER Models	KULLANIM YERİ Place Of Use	ORJINAL NO 1 Orijinal No 1	ORJINAL NO 1 Orijinal No 2	EŞDEĞER NO 1 Equivalent No 1	EŞDEĞER NO 1 Equivalent No 2	ÖLÇÜLER MM. Dimensions-MM.					TİP Type	MALZEME Material
045543	TRAKTÖR SERİSİ Tractor Series	HİD. KALDIRMA SİSTEMİ Hydraulic Lifting System	215100290		12010981		55,00	70,00	-	8,00	-	L3	NBR
040872	TRAKTÖR SERİSİ Tractor Series	MİL KEÇESİ Shaft Seal	215191070		12010895		32,00	47,00	-	7,00	-	L3TL	NBR
045355	TRAKTÖR SERİSİ Tractor Series	MİL KEÇESİ Shaft Seal	215201310		12011191		60,00	75,00	-	8,00	-	L3	NBR
047456	TRAKTÖR SERİSİ Tractor Series	MİL KEÇESİ Shaft Seal	215202310		12011192	12010999 12015900	60,00	80,00	-	10,00	12,00	L3L	NBR
047697	TRAKTÖR SERİSİ Tractor Series	MİL KEÇESİ Shaft Seal	215104340		12011011		65,00	100,00	-	10,00	-	L3TL	NBR

## MOTOR GRUBU / Engine Group

SKT NO	KULLANILAN MODELLER Models	KULLANIM YERİ Place Of Use	ORJINAL NO 1 Orijinal No 1	ORJINAL NO 2 Orijinal No 2	EŞDEĞER NO 1 Equivalent No 1	EŞDEĞER NO 2 Equivalent No 2	ÖLÇÜLER MM. Dimensions-MM.					TİP Type	MALZEME Material
047588-V	TRAKTÖR SERİSİ Tractor Series	KRANK ÖN Crank Shaft Front	1447689M1	87429971	12014982		57,15	76,45	-	9,52	11,11	L3L SAĞ -Right	FKM
047558-V	TRAKTÖR SERİSİ Tractor Series	KRANK ÖN Crank Shaft Front	1447690M1		12014981		60,33	79,62	-	9,52	11,11	L3L SAĞ -Right	FKM
047894-V	PERKİNS MOTOR Perkins Type Motor	KRANK ÖN Crank Shaft Front	1447690M1		12014981	578.010	60,33	79,63	-	9,33	11,23	L3TL SAĞ -Right	FKM
415171-V	TRAKTÖR SERİSİ Tractor Series	KRANK ARKA Crank Shaft Rear	1447691M1		12010753	15026903	133,35	158,94	159,16	11,11	13,00	L13TL SOL -Left	FKM
415137-V	TRAKTÖR SERİSİ Tractor Series	KRANK ARKA Crank Shaft Rear	1447691M1		12010753	15026903	133,35	159,05	-	11,11	13,00	L3L SOL -Left	FKM
45-084-V	TRAKTÖR SERİSİ Tractor Series	SUPAP Valve Stem Seal	2418M519	4225347M1	12035737		9,00	13,05	35,00	12,90	17,20	LSY5T	FKM
041174	TRAKTÖR SERİSİ Tractor Series	YAKIT POMPASI Fuel Pump	1441802X4		12011122	12010846	25,00	35,00	-	7,00	-	L3	NBR
045361	TRAKTÖR SERİSİ Tractor Series	SU POMPASI Water Pump	973665M1		12010908		35,00	52,00	-	10,00	-	L3L	NBR

## AKS ve DİFERANSİYEL GRUBU / Axle and Differential Group

SKT NO	KULLANILAN MODELLER Models	KULLANIM YERİ Place Of Use	ORJINAL NO 1 Orijinal No 1	ORJINAL NO 2 Orijinal No 2	EŞDEĞER NO 1 Equivalent No 1	EŞDEĞER NO 2 Equivalent No 2	ÖLÇÜLER MM. Dimensions-MM.					TİP Type	MALZEME Material
046128-NK	TRAKTÖR SERİSİ Tractor Series	ÖN AKS Front Axle	3019963X1		12012503		50,00	75,00	-	12,00	-	KOMBI 3	NBR+YÜN
417132	TRAKTÖR SERİSİ Tractor Series	ÖN AKS Front Axle	3541510M1 RE73082	354151M1	12013126		150,00	176,00	-	15,50	16,00	SC6	NBR
417128	TRAKTÖR SERİSİ Tractor Series	ÖN AKS Front Axle	3764634M1	3665712M1 452140A1	12018035	12014283	150,00	180,00	-	14,50	16,00	SC6	NBR
417120	JX90 JX95 TRAKTÖR	ÖN AKS Front Axle	3696866M2	3429791M1	12019930		165,00	190,00	-	15,50	-	SC6-SS-RL	NBR
420074	TRAKTÖR-İŞ MAK.	ÖN AKS Front Axle	3015547X1- 3429815M1	3429815M3	12015136		190,00	220,00	-	16,00	18,00	SC6	NBR
041331-NK	TRAKTÖR-İŞ MAK.	ÖN AKS DİFERANSİYEL Front Axle-Differential	3019952X1		12001879		30,00	44,00	-	11,00	-	KOMBI 3	NBR+YÜN
046199-NK	TRAKTÖR SERİSİ Tractor Series	ÖN AKS DİFERANSİYEL Front Axle-Differential	3541441M1	0-125944	12001882		35,00	52,00	-	16,00	-	KOMBI 3	NBR-YÜN
041252-NL	TRAKTÖR SERİSİ Tractor Series	ÖN AKS DİFERANSİYEL Front Axle-Differential	3428829M1	85824343	12013519	12018617	30,00	44,00	-	14,00	-	KOMBI 1X	NBR+TPU

## AKS ve DİFERANSİYEL GRUBU / Axle and Differential Group

SKT NO	KULLANILAN MODELLER Models	KULLANIM YERİ Place Of Use	ORJINAL NO 1 Original No 1	ORJINAL NO 1 Original No 2	EŞDEĞER NO 1 Equivalent No 1	EŞDEĞER NO 1 Equivalent No 2	ÖLÇÜLER MM. Dimensions-MM.					TİP Type	MALZEME Material
045665	TRAKTÖR SERİSİ Tractor Series	ÖN AKS DİFERANSİYEL Front Axle-Differential	2714076M1	2714076M2	1201146		35,00	55,00	-	11,00	-	L3L	NBR
046298-NK	TRAKTÖR SERİSİ Tractor Series	ÖN AKS DİFERANSİYEL Front Axle-Differential	3019957X1		12001886		40,00	55,00	-	10,00	-	KOMBI 3	NBR+YÜN
046297-NL	TRAKTÖR SERİSİ Tractor Series	ÖN AKS DİFERANSİYEL Front Axle-Differential	3015377X1		12016507		42,00	62,00	-	21,50	-	KOMBI 1X	NBR-TPU
046223-NL	4x4 TRAKTÖR SERİSİ 4x4 Tractor Series	ÖN AKS DİFERANSİYEL Front Axle-Differential	215291110	3428259M1	12014048		50,00	72,00	-	16,50	-	KOMBI 1X	NBR+TPU
047928-NK	TRAKTÖR SERİSİ Tractor Series	ÖN AKS DİFERANSİYEL Front Axle-Differential	3659390M1		12013176		55,00	80,00	-	11,00	-	KOMBI 3	NBR+YÜN
047823-NL	TRAKTÖR SERİSİ Tractor Series	ÖN AKS DİFERANSİYEL Front Axle-Differential	3428942M1		12014159		55,00	82,00	-	16,50	-	KOMBI 1X	NBR+TPU
047930-PN	TRAKTÖR SERİSİ Tractor Series	ÖN AKS DİFERANSİYEL Front Axle-Differential	3764632M1		12016445		56,00	80,00	-	13,00	14,50	SC6	ACM+NBR
417141-NK	TRAKTÖR SERİSİ Tractor Series	ÖN AKS DİFERANSİYEL Front Axle-Differential	3019959X1		12001925		165,00	190,00	-	17,00	-	KOMBI 3	NBR+YÜN
417127	TRAKTÖR SERİSİ Tractor Series	ÖN AKS DİFERANSİYEL Front Axle-Differential	3429790M1	3429790M2	12015149		165,00	195,00	-	16,50	18,00	SC6	NBR
420069-NK	TRAKTÖR SERİSİ Tractor Series	ÖN AKS DİFERANSİYEL Front Axle-Differential	30199660X1	5133736	12001926		190,00	220,00	-	20,00	-	KOMBI 3	NBR+YÜN
045779	TRAKTÖR SERİSİ Tractor Series	DİFERANSİYEL SİSTEMİ Differential System	3015293X1		12011168		45,00	65,00	-	10,00	-	L3L	NBR
045934	TRAKTÖR SERİSİ Tractor Series	DİFERANSİYEL SİSTEMİ Differential System	3015353X1	391346X1	12011177		50,00	72,00	-	7,00	-	L3BTL	NBR
047756	TRAKTÖR SERİSİ Tractor Series	DİFERANSİYEL SİSTEMİ Differential System	3015098X1		12011201		75,00	95,00	-	10,00	-	L13TL SS-RL	NBR
410518-NK	TRAKTÖR SERİSİ Tractor Series	ARKA AKS Rear Axle	3019953X1		12001907		75,00	102,00	-	14,00	-	KOMBI 3	NBR+YÜN
410449	TRAKTÖR SERİSİ Tractor Series	ARKA AKS Rear Axle	3015275X1		12016635	12014974	85,00	110,00	-	14,50	-	SC6	NBR
410406	TRAKTÖR SERİSİ Tractor Series	ARKA AKS Rear Axle	3019954X1		12001909		85,00	110,00	-	16,00	-	KOMBI 3	NBR
417117	TRAKTÖR SERİSİ Tractor Series	ARKA AKS Rear Axle	3015376X1	3429791M1	12015133		165,00	190,00	-	15,50	17,00	SC6	NBR
410485	TRAKTÖR SERİSİ Tractor Series	ARKA AKS DIŞ Rear Axle Outer	3699800M1	894763M4	12018598		73,02	102,00	-	15,60	-	SPSC2	NBR
410252	TRAKTÖR SERİSİ Tractor Series	ARKA AKS İÇ Rear Axle Inner	975127M1	976099M1	12011206	12011036	85,00	110,00	-	12,00	-	L3L	NBR

# LANDINI

## AKS ve DİFERANSİYEL GRUBU / Axle and Differential Group

SKT NO	KULLANILAN MODELLER Models	KULLANIM YERİ Place Of Use	ORJINAL NO 1 Orijinal No 1	ORJINAL NO 2 Orijinal No 2	EŞDEĞER NO 1 Equivalent No 1	EŞDEĞER NO 2 Equivalent No 2	ÖLÇÜLER MM. Dimensions-MM.					TİP Type	MALZEME Material
046000	TRAKTÖR SERİSİ Tractor Series	DİFERANSİYEL SİSTEMİ Differential System	1441815X1	44908432	12010932		40,00	55,00	-	7,00	-	L3	NBR

## ŞANZİMAN GRUBU / Gearbox Group

SKT NO	KULLANILAN MODELLER Models	KULLANIM YERİ Place Of Use	ORJINAL NO 1 Orijinal No 1	ORJINAL NO 2 Orijinal No 2	EŞDEĞER NO 1 Equivalent No 1	EŞDEĞER NO 2 Equivalent No 2	ÖLÇÜLER MM. Dimensions-MM.					TİP Type	MALZEME Material
045609-P	TRAKTÖR SERİSİ Tractor Series	ŞANZİMAN ÖN Gearbox Front	3382237M1		12014056	19026746	45,00	62,00	-	10,00	-	L3 SAĞ -Right	ACM
045948	TRAKTÖR SERİSİ Tractor Series	ŞANZ. KAVRAMA MİLİ Gearbox - Coupling Shaft	3673481X1		12011147		35,00	62,00	-	7,00	-	L3TL	NBR
045224	TRAKTÖR SERİSİ Tractor Series	PTO KUYRUK MİLİ Power Take Off Shaft	973933M1		12010910		35,00	56,00	-	10,00	-	L3	NBR
040591	TRAKTÖR SERİSİ Tractor Series	ŞANZİMAN MİLİ Gearbox Shaft	3015264X1		12011111		16,00	28,00	-	7,00	-	L3L	NBR
041160	TRAKTÖR SERİSİ Tractor Series	ŞANZİMAN MİLİ Gearbox Shaft	3009856X1		12011114		20,00	30,00	-	7,00	-	L3	NBR
040745	TRAKTÖR SERİSİ Tractor Series	ŞANZİMAN MİLİ Gearbox Shaft	1441802X1	40002590	12011122		25,00	35,00	-	7,00	-	L3TL	NBR
045269	TRAKTÖR SERİSİ Tractor Series	ŞANZİMAN MİLİ Gearbox Shaft	3008780X1	973454M1	12010938	12000504	40,00	65,00	-	10,00	-	L3	NBR
047229	TRAKTÖR SERİSİ Tractor Series	ŞANZİMAN MİLİ Gearbox Shaft	1442640X1		12014022		70,00	85,00	-	8,00	-	L3	NBR

## DİĞER GRUPLAR / Others Group

SKT NO	KULLANILAN MODELLER Models	KULLANIM YERİ Place Of Use	ORJINAL NO 1 Orijinal No 1	ORJINAL NO 2 Orijinal No 2	EŞDEĞER NO 1 Equivalent No 1	EŞDEĞER NO 2 Equivalent No 2	ÖLÇÜLER MM. Dimensions-MM.					TİP Type	MALZEME Material
045543	TRAKTÖR SERİSİ Tractor Series	HİD. KALDIRMA SİSTEMİ Hydraulic Lifting System	1442216X1		12010981		55,00	70,00	-	8,00	-	L3	NBR
040278	TRAKTÖR SERİSİ Tractor Series	MİL KEÇESİ Shaft Seal	3015292X1		12010836		22,00	35,00	-	7,00	-	L3	NBR
045355	TRAKTÖR SERİSİ Tractor Series	MİL KEÇESİ Shaft Seal	3015361X1		12011191		60,00	75,00	-	8,00	-	L3	NBR
047087	TRAKTÖR SERİSİ Tractor Series	MİL KEÇESİ Shaft Seal	391316X1	973191M1	12010999	12011192	60,00	80,00	-	10,00	-	L3	NBR
047450	TRAKTÖR SERİSİ Tractor Series	MİL KEÇESİ Shaft Seal	1441258X1		12011007	12011008	65,00	85,00	-	10,00	-	L3	NBR

## MOTOR GRUBU / Engine Group

SKT NO	KULLANILAN MODELLER Models	KULLANIM YERİ Place Of Use	ORJINAL NO 1 Orijinal No 1	ORJINAL NO 1 Orijinal No 2	EŞDEĞER NO 1 Equivalent No 1	EŞDEĞER NO 1 Equivalent No 2	ÖLÇÜLER MM. Dimensions-MM.					TİP Type	MALZEME Material
045850-V	BİÇERDÖVER Combine Harvester	KRANK ÖN Crank Shaft Front	98461684	40000010	12014859		42,00	65,00	-	10,00	-	L13TL SAĞ -Right	FKM
046145-V	BİÇERDÖVER Combine Harvester	KRANK ÖN Crank Shaft Front	84478262 94478264	4101330 4101333	12013479 12011460	01026318	42,00	65,00	-	12,00	-	L13TL SAĞ -Right	FKM
412235-V	BİÇERDÖVER Combine Harvester	KRANK ARKA Crank Shaft Rear	98461686		12016274	12011318	114,00	135,00	-	13,00	-	L1L SOL -Left	FKM
412281-V	BİÇERDÖVER Combine Harvester	KRANK ARKA Crank Shaft Rear	98461686	40101341	12016274	12011318	114,00	135,00	-	13,00	-	L13TL SOL -Left	FKM
045361	TRAKTÖR SERİSİ Tractor Series	SU POMPASI Water Pump	350358306		12010908		35,00	52,00	-	10,00	-	L3L	NBR

## DİĞER GRUPLAR / Others Group

SKT NO	KULLANILAN MODELLER Models	KULLANIM YERİ Place Of Use	ORJINAL NO 1 Orijinal No 1	ORJINAL NO 1 Orijinal No 2	EŞDEĞER NO 1 Equivalent No 1	EŞDEĞER NO 1 Equivalent No 2	ÖLÇÜLER MM. Dimensions-MM.					TİP Type	MALZEME Material
046128-NK	BİÇERDÖVER Combine Harvester	ÖN AKS Front Axle	353587178		12012503		50,00	75,00	-	12,00	-	KOMBI 3	NBR+YÜN
045062	BİÇERDÖVER Combine Harvester	MİL KEÇESİ Shaft Seal	215100230	2.1510.023.0			45,00	60,00	-	10,00	-	L3	NBR
417121	BİÇERDÖVER Combine Harvester	MİL KEÇESİ Shaft Seal	353587179		12013074		170,00	190,00	-	15,00	-	KOMBI 3	NBR
045405	BİÇERDÖVER Combine Harvester	ŞANZİMAN MİLİ Gearbox Shaft	353583182		12010940		40,00	72,00	-	10,00	-	L3	NBR

## MOTOR GRUBU / Engine Group

SKT NO	KULLANILAN MODELLER Models	KULLANIM YERİ Place Of Use	ORJINAL NO 1 Orijinal No 1	ORJINAL NO 1 Orijinal No 2	EŞDEĞER NO 1 Equivalent No 1	EŞDEĞER NO 1 Equivalent No 2	ÖLÇÜLER MM. Dimensions-MM.					TİP Type	MALZEME Material
045529	154-184	KRANK ÖN Crank Shaft Front	13H6516				39,69	59,08	-	9,52	-	L3L SAĞ -Right	NBR
045529-S	154-184	KRANK ÖN Crank Shaft Front	13H6516		12011460	12013479	39,69	59,08	-	9,52	-	L3L SAĞ -Right	VMQ
045529-V	154-184	KRANK ÖN Crank Shaft Front	13H6516		12011460	12013479	39,69	59,08	-	9,52	-	L3L SAĞ -Right	FKM
410236-S	154-184	KRANK ARKA Crank Shaft Rear	13H2457				88,90	105,05	-	9,52	-	L3 SOL-Left	VMQ
410236-V	154-184	KRANK ARKA Crank Shaft Rear	13H2457				88,90	105,05	-	9,52	-	L3 SOL-Left	FKM
45-008-V	154-184	SUPAP Valve Stem Seal	12B2104				8,73	14,32	16,66	6,73	11,11	L	FKM

## DİĞER GRUPLAR / Others Group

SKT NO	KULLANILAN MODELLER Models	KULLANIM YERİ Place Of Use	ORJINAL NO 1 Orijinal No 1	ORJINAL NO 1 Orijinal No 2	EŞDEĞER NO 1 Equivalent No 1	EŞDEĞER NO 1 Equivalent No 2	ÖLÇÜLER MM. Dimensions-MM.					TİP Type	MALZEME Material
045570	154-184	ÖN AKS Front Axle	BTJ4026				46,03	63,62	-	14,28	-	LL1	NBR
047454	154-184	ARKA AKS Rear Axle	BTJ90				57,15	81,20	-	15,87	-	L3L	NBR
047453	154-184	ARKA AKS DIŞ Rear Axle Outer	BTJ78				44,85	76,22	-	12,70	-	L6L	NBR
040480	154-184	ARKA AKS PORYA İÇ Rear Axle Inner	ATJ2045				38,10	47,70	-	4,76	-	L1	NBR
040406	154-184	DİFERANSİYEL KİLİDİ Differential Locking Sys.	ATJ2050				15,87	22,32	-	3,17	-	L5	NBR
040223	154-184	ŞANZİMAN ÖN Gearbox Front	22H475				27,00	44,65	-	9,52	-	L3	NBR
040479	154-184	ŞANZ. KLM ÇIKIŞ MİLİ Speedometer Shaft	12A1309				9,52	14,37	-	3,57	-	L5	NBR
045580	154-184	PTO KUYRUK MİLİ Power Take Off Shaft	ATJ2103				47,62	64,46	-	6,35	-	L3	NBR
040273	154-184	DİREKSİYON MİLİ Steering Shaft	17H6490				28,00	38,00	-	7,00	-	L3	NBR
040490	154-184	HİDROLİK POMPA Hydraulic Pump	4PI100020				17,46	28,75	-	7,93	-	L3X	NBR



## MOTOR GRUBU / Engine Group

SKT NO	KULLANILAN MODELLER Models	KULLANIM YERİ Place Of Use	ORJINAL NO 1 Orijinal No 1	ORJINAL NO 1 Orijinal No 2	EŞDEĞER NO 1 Equivalent No 1	EŞDEĞER NO 1 Equivalent No 2	ÖLÇÜLER MM. Dimensions-MM.					TİP Type	MALZEME Material
047629	20-35-65-135-165 4.192 - 4.203 MOT.	KRANK ÖN Crank Shaft Front	2414111A		-	-	57,15	76,28	-	19,45	-	SL1L1	NBR
047629-S	MF 135-165-240	KRANK ÖN Crank Shaft Front	2414111A				57,15	76,28	-	19,45	-	SL1L1	VMQ
047588-V	MF 135-240	KRANK ÖN Crank Shaft Front	1447689M1	2415344	12014982		57,15	76,45	-	9,52	11,11	L3L SAÇ -Right	FKM
047558-V	MF 165-240-285	KRANK ÖN Crank Shaft Front	2418F436	1447690M1 2415361	12014981		60,33	79,62	-	9,52	-	L3L SAÇ -Right	FKM
047894-V	MF 165-240-285	KRANK ÖN Crank Shaft Front	1447690M1	2418F437	12014981	578.010	60,33	79,63	-	9,33	11,23	L3TL SAÇ -Right	FKM
412276-V	MF 4x4 SERİLER	KRANK ARKA Crank Shaft Rear	04253332		12014877		120,00	140,00	-	13,00	10,50	LL13 SOL -Left	FKM
420056-VAE	MF 1103-1104-3050-3060	KRANK ARKA Crank Shaft Rear	4224532M1	4142V066	20031744		133,30	197,00	219,00	24,00	-	SPL1L SOL -Left	FKM+AEM
415171-V	MF 135-165-240-265-285	KRANK ARKA Crank Shaft Rear	2418F475	1447691M1	12010753	15026903	133,35	158,94	159,16	11,11	13,00	L13TL SOL -Left	FKM
415137-V	MF 135-165-240-265-285	KRANK ARKA Crank Shaft Rear	2418F475	1447691M1	12010753	15026903	133,35	159,05	-	11,11	-	L3L SOL -Left	FKM
415106-S	MF 135-165-240-265-285	KRANK ARKA Crank Shaft Rear	2415391		15026903	12010753	133,35	159,05	-	12,70	-	L3 SOL -Left	VMQ
45-084-V	3400-5400-6400 Tractor Series - Perkins Engine	SUPAP Valve Stem Seal	2418M519	4225347M1	12035737		9,00	13,05	35,00	12,90	17,20	LSY5T	FKM
45-009-V	MF 265-285-4.236-4.212-4.248 Tractor Series - Perkins Engine	SUPAP Valve Stem Seal	33817117	3637041M1 736840M1	12016623	292610	9,45	14,25	16,61	10,69	14,27	L	FKM
040140	TRAKTÖR SERİSİ Tractor Series	YAĞ POMPASI Oil Pump	1442907X1				20,00	30,00	-	7,00	-	L3	NBR
040592	MF 4x4 SERİLER	YAĞ POMPASI Oil Pump	1442907X1	3009856			20,00	30,00	-	7,00	-	L3L	NBR
041174	TRAKTÖR SERİSİ Tractor Series	YAKIT POMPASI Fuel Pump	1441802X1		12011122	12010846	25,00	35,00	-	7,00	-	L3	NBR
409	MF 165-240-265-285	SU POMPASI Water Pump	2415207	2415209			15,87	36,60	42,86	7,54	19,05	KO10	NBR
439	MF 135-165-240-265-285	SU POMPASI Water Pump	2415216				15,87	36,60	42,86	7,54	17,82	KO18	NBR
040135	MF 135-165-240	SU POMPASI Water Pump	195501M1				28,58	39,90	-	9,52	-	L3	NBR

# MASSEY FERGUSON

## MOTOR GRUBU / Engine Group

SKT NO	KULLANILAN MODELLER Models	KULLANIM YERİ Place Of Use	ORJINAL NO 1 Orijinal No 1	ORJINAL NO 2 Orijinal No 2	EŞDEĞER NO 1 Equivalent No 1	EŞDEĞER NO 2 Equivalent No 2	ÖLÇÜLER MM. Dimensions-MM.					TİP Type	MALZEME Material
045361	TRAKTÖR SERİSİ Tractor Series	SU POMPASI Water Pump	973665M1		12010908		35,00	52,00	-	10,00	-	L3L	NBR
045561	MF 135-240	SU POMPASI Water Pump	195473				44,45	54,08	-	4,76	-	L1	NBR
045586	MF 135-240	SU POMPASI Water Pump	195473M1				44,45	54,08	-	4,76	-	L5	NBR
045587	MF 165-175-285	SU POMPASI Water Pump	831236M1				44,45	60,40	-	6,35	-	L1	NBR
045589	MF 135-165-240	SU POMPASI Water Pump	195474M1				50,80	70,10	-	12,70	-	L3	NBR
047471	MF 165-285	SU POMPASI Water Pump	894028M1				63,50	92,23	-	12,70	-	L1L	NBR
040582-5	TRAKTÖR SERİSİ Tractor Series	EKSOZTER Exhauster	241503				22,22	35,94	46,04	9,92	-	SPL3 SAĞ -Right	VMQ

66

## AKS ve DİFERANSİYEL GRUBU / Axle and Differential Group

SKT NO	KULLANILAN MODELLER Models	KULLANIM YERİ Place Of Use	ORJINAL NO 1 Orijinal No 1	ORJINAL NO 2 Orijinal No 2	EŞDEĞER NO 1 Equivalent No 1	EŞDEĞER NO 2 Equivalent No 2	ÖLÇÜLER MM. Dimensions-MM.					TİP Type	MALZEME Material
4835-K	MF 165-265	ÖN AKS Front Axle	183021M1	882262M1 800410014			37,31	54,34	-	6,35	-	K	YÜN
046201-NL	TRAKTÖR SERİSİ Tractor Series	ÖN AKS Front Axle	ERR144485	2110602001	12014977	993.460	45,00	60,00	-	16,00	-	KOMBI 1X	NBR+TPU
045149	TRAKTÖR SERİSİ Tractor Series	ÖN AKS Front Axle	0080154U1	AR49592 AT10344	12010956	12011168	45,00	65,00	-	10,00	-	L3	NBR
045591	MF 135-165-240-265	ÖN AKS Front Axle	897242M1				47,62	70,02	-	9,52	-	L3	NBR
046128-NK	TRAKTÖR SERİSİ Tractor Series	ÖN AKS Front Axle	3019963X1		12012503		50,00	75,00	-	12,00	-	KOMBI 3	NBR+YÜN
047490	MF 165-265-285	ÖN AKS Front Axle	897702M1				60,33	85,90	-	12,70	-	L3	NBR
417128	TRAKTÖR SERİSİ Tractor Series	ÖN AKS Front Axle	053850R1	3764634M1 3907166M1	12018035	12014283	150,00	180,00	-	14,50	16,00	SC6	NBR
417117	70-56 70 HP	ÖN AKS Front Axle	3015376X1	3426809M1	12015134		165,00	190,00	-	15,50	17,00	SC6	NBR
420074	TRAKTÖR SERİSİ Tractor Series	ÖN AKS Front Axle	3015547X1- 3429815M1	3429815M3	12015136		190,00	220,00	-	16,00	18,00	SC6	NBR

## AKS ve DİFERANSİYEL GRUBU / Axle and Differential Group

SKT NO	KULLANILAN MODELLER Models	KULLANIM YERİ Place Of Use	ORJINAL NO 1 Orijinal No 1	ORJINAL NO 1 Orijinal No 2	EŞDEĞER NO 1 Equivalent No 1	EŞDEĞER NO 1 Equivalent No 2	ÖLÇÜLER MM. Dimensions-MM.					TİP Type	MALZEME Material
4MH-408-U	4x4-3085 SERİSİ	4x4 ÖN AKS PİMİ Front Axle KING PIN	3759661M1				66,00	71,50	78,00	4,22	6,00	MH	TPU
041331-NK	TRAKTÖR SERİSİ Tractor Series	ÖN AKS DİFERANSİYEL Front Axle-Differential	3019952X1		12001879		30,00	44,00	-	11,00	-	KOMBI 3	NBR+YÜN
041252-NL	TRAKTÖR SERİSİ Tractor Series	ÖN AKS DİFERANSİYEL Front Axle-Differential	3428829M1	061342R1	12013519	12018617	30,00	44,00	-	14,00	-	KOMBI 1X	NBR+TPU
045665	TRAKTÖR SERİSİ Tractor Series	ÖN AKS DİFERANSİYEL Front Axle-Differential	2714076M1	2714076M2	12011146		35,00	55,00	-	11,00	-	L3L	NBR
046298-NK	TRAKTÖR SERİSİ Tractor Series	ÖN AKS DİFERANSİYEL Front Axle-Differential	3019957X1		12001886		40,00	55,00	-	10,00	-	KOMBI 3	NBR+YÜN
046142-NL	398-3085-3105	ÖN AKS DİFERANSİYEL Front Axle-Differential	3428064M1		12013464		40,00	60,00	-	18,50	-	KOMBI 1X	NBR+TPU
046297-NL	TRAKTÖR SERİSİ Tractor Series	ÖN AKS DİFERANSİYEL Front Axle-Differential	3015377X1		12016507		42,00	62,00	-	21,50	-	KOMBI 1X	NBR-TPU
046082-NL	MF 285-4x4 SERİLERİ	ÖN AKS DİFERANSİYEL Front Axle-Differential	37657556M1	107190T1	12018030		45,00	65,00	-	25,00	-	KOMBI 2X	NBR+TPU
046083	4x4 TRAKTÖR SERİSİ 4x4 Tractor Series	ÖN AKS DİFERANSİYEL Front Axle-Differential	3765528M1-M2	053965R1	12015392		45,00	70,00	-	14,00	17,00	SC6	NBR
4MH-417-L	TRAKTÖR SERİSİ Tractor Series	ÖN AKS DİFERANSİYEL Front Axle-Differential	104816T1	3429317			46,00	64,29	-	6,00	-	L	TPU
046223-NL	4x4 TRAKTÖR SERİSİ 4x4 Tractor Series	ÖN AKS DİFERANSİYEL Front Axle-Differential	3428259M1		12014048		50,00	72,00	-	16,50	-	KOMBI 1X	NBR+TPU
047928-NK	TRAKTÖR SERİSİ Tractor Series	ÖN AKS DİFERANSİYEL Front Axle-Differential	3659390M1		12013176		55,00	80,00	-	11,00	-	KOMBI 3	NBR+YÜN
047823-NL	MF 265	ÖN AKS DİFERANSİYEL Front Axle-Differential	3428942M1		12014159		55,00	82,00	-	16,50	-	KOMBI 1X	NBR+TPU
047930-PN	TRAKTÖR SERİSİ Tractor Series	ÖN AKS DİFERANSİYEL Front Axle-Differential	3764632M1		12016445		56,00	80,00	-	13,00	14,50	SC6	ACM+NBR
047920-NL	TRAKTÖR SERİSİ Tractor Series	ÖN AKS DİFERANSİYEL Front Axle-Differential	061320R1	3789575M1	12001902		58,00	82,00	-	15,00	-	KOMBI 1X	NBR+TPU
047920-VL	TRAKTÖR SERİSİ Tractor Series	ÖN AKS DİFERANSİYEL Front Axle-Differential	061320R1	3789575M1	12017237		58,00	82,00	-	16,00	-	KOMBI 1X	FKM+TPU

# MASSEY FERGUSON

## AKS ve DİFERANSİYEL GRUBU / Axle and Differential Group

SKT NO	KULLANILAN MODELLER Models	KULLANIM YERİ Place Of Use	ORJINAL NO 1 Original No 1	ORJINAL NO 2 Original No 2	EŞDEĞER NO 1 Equivalent No 1	EŞDEĞER NO 2 Equivalent No 2	ÖLÇÜLER MM. Dimensions-MM.					TİP Type	MALZEME Material
415220	4x4 TRAKTÖR SERİSİ 4x4 Tractor Series	ÖN AKS DİFERANSİYEL Front Axle-Differential	068383R1	VA047703	12016448		130,00	160,00	-	14,50	16,00	SC6	NBR
417141-NK	TRAKTÖR SERİSİ Tractor Series	ÖN AKS DİFERANSİYEL Front Axle-Differential	3019959X1		12001925		165,00	190,00	-	17,00	-	KOMBI 3	NBR+YÜN
417127	276G-286G-1004	ÖN AKS DİFERANSİYEL Front Axle-Differential	3429790M1	3429790M2	12015149		165,00	195,00	-	16,50	18,00	SC6	NBR
420069-NK	MF 398 4x4 SERİLER	ÖN AKS DİFERANSİYEL Front Axle-Differential	30199660X1	5133736	12001926		190,00	220,00	-	20,00	-	KOMBI 3	NBR+YÜN
046197-VN	MF 4x4 SERİLER	DİFERANSİYEL SİSTEMİ Differential System	3699802M2				44,40	63,75	-	17,50	18,70	SPSC2	FKM+NBR
045779	TRAKTÖR SERİSİ Tractor Series	DİFERANSİYEL SİSTEMİ Differential System	974390M1		12011168		45,00	65,00	-	10,00	-	L3L	NBR
045934	TRAKTÖR SERİSİ Tractor Series	DİFERANSİYEL SİSTEMİ Differential System	3015353X1	391346X1	12011177		50,00	72,00	-	7,00	-	L3BTL	NBR
047699	MF 240 - DİSK FRENLİ MOD.	ARKA AKS KOVAN Rear Axle	3698907M1				69,85	92,25	92,15	14,27	-	SC4	NBR
410518-NK	TRAKTÖR SERİSİ Tractor Series	ARKA AKS Rear Axle	3019953X1		12001907		75,00	102,00	-	14,00	-	KOMBI 3	NBR+YÜN
047059	TRAKTÖR SERİSİ Tractor Series	ARKA AKS Rear Axle	976099M1	5196487	12011026	01002942	80,00	100,00	-	10,00	-	L3	NBR
410449	TRAKTÖR SERİSİ Tractor Series	ARKA AKS Rear Axle	3015275X1	9700602301	12016635	12014974	85,00	110,00	-	14,50	-	SC6	NBR
410406	TRAKTÖR SERİSİ Tractor Series	ARKA AKS Rear Axle	3019954X1		12001909		85,00	110,00	-	16,00	-	KOMBI 3	NBR
412159-V	TRAKTÖR SERİSİ Tractor Series	ARKA AKS Rear Axle	4K97190	40001930			125,00	150,00	-	13,00	-	L1L	FKM
047194-NK	MF 165	ARKA AKS DIŞ Rear Axle Outer	996238M1				66,67	96,30	-	15,87	-	SLK	NBR
047472	MF 135-240	ARKA AKS DIŞ Rear Axle Outer	195677M1	273095R91			69,85	92,15	-	14,28	-	L1L	NBR
410250	MF 165-240-265-285	ARKA AKS DIŞ Rear Axle Outer	894763M5	894763			73,02	101,80	-	14,28	-	SL1L5	NBR
410485	MF 265	ARKA AKS DIŞ Rear Axle Outer	3699800M2	894763M4	12018598		73,02	102,00	-	15,60	-	SPSC2	NBR
045215	MF 135-240	ARKA AKS İÇ Rear Axle Inner	195678M2	195678			53,98	73,12	-	12,82	15,03	SPSL	NBR

## AKS ve DİFERANSİYEL GRUBU / Axle and Differential Group

SKT NO	KULLANILAN MODELLER Models	KULLANIM YERİ Place Of Use	ORJINAL NO 1 Orijinal No 1	ORJINAL NO 1 Orijinal No 2	EŞDEĞER NO 1 Equivalent No 1	EŞDEĞER NO 1 Equivalent No 2	ÖLÇÜLER MM. Dimensions-MM.					TİP Type	MALZEME Material
047367	MF 165	ARKA AKS PORYA İÇ Rear Axle Inner	881021M1	832954M3 1860482M91			53,98	81,12	-	22,22	-	SPL1	NBR
047489	MF 285	ARKA AKS PORYA İÇ Rear Axle Inner	1860954M1	894782M2			60,33	85,85	-	23,81	-	L1X	VMQ
410252	TRAKTÖR SERİSİ Tractor Series	ARKA AKS İÇ Rear Axle Inner	975127M1	976099M1	12011206	12011036	85,00	110,00	-	12,00	-	L3L	NBR
045944	TRAKTÖR SERİSİ Tractor Series	AKS SİSTEMİ Axle System	3006847X1		12011126	12010860	25,00	52,00	-	7,00	-	L3TL	NBR
047087	TRAKTÖR SERİSİ Tractor Series	AKS SİSTEMİ Axle System	391316X1	973191M1	12010999	12011192	60,00	80,00	-	10,00	-	L3	NBR
4D-398	MF 4x4 SERİLER	ARKA AKS FREN MİLİ Rear Axle Brake Shaft	1810992 3477388M1	77320224			6,90	30,00	38,00	9,10	36,20	L5	NBR
4D-037	MF 135-165-240-265-285	ARKA AKS FREN MİLİ Rear Axle Brake Shaft	1860959M1	83963609 E7NN2N336AA			14,25	50,80	63,50	9,30	43,26	L5	NBR
047674	TRAKTÖR SERİSİ Tractor Series	DİF.ÖN-MAHRUTİ Differential Front	976135M1		12015749 12011187	01029598	55,00	80,00	-	10,00	-	L3TL	NBR
046000	TRAKTÖR SERİSİ Tractor Series	DİFERANSİYEL SİSTEMİ Differential System	1441815X1	025186	12010932		40,00	55,00	-	7,00	-	L3	NBR
040707	MF 135-240-265	DİFERANSİYEL KİLİDİ Differential Locking Sys.	832741M1	831575M1			22,22	31,97	-	5,55	-	L3L	NBR

## ŞANZİMAN GRUBU / Gearbox Group

SKT NO	KULLANILAN MODELLER Models	KULLANIM YERİ Place Of Use	ORJINAL NO 1 Orijinal No 1	ORJINAL NO 1 Orijinal No 2	EŞDEĞER NO 1 Equivalent No 1	EŞDEĞER NO 1 Equivalent No 2	ÖLÇÜLER MM. Dimensions-MM.					TİP Type	MALZEME Material
040737	MF 165-265-285	ŞANZİMAN ÖN Gearbox Front	883935M4				28,58	38,17	-	6,35	-	L1	NBR
040135	MF 240	ŞANZİMAN ÖN Gearbox Front	195501M1				28,58	39,90	-	9,52	-	L3	NBR
040562	MF 135-165	ŞANZİMAN ÖN Gearbox Front	195501M1				28,58	39,95	-	7,93	-	L3L	NBR
040492	MF 165-240-265-285	ŞANZİMAN ÖN DIŞ Gearbox Front Outer	1860011M1				28,58	41,35	-	9,52	-	L1	NBR
045588	MF 135	ŞANZİMAN ÖN Gearbox Front	195523M1	195523M1			28,58	57,35	-	9,52	-	L3	NBR

# MASSEY FERGUSON

## ŞANZIMAN GRUBU / Gearbox Group

SKT NO	KULLANILAN MODELLER Models	KULLANIM YERİ Place Of Use	ORJİNAL NO 1 Original No 1	ORJİNAL NO 2 Original No 2	EŞDEĞER NO 1 Equivalent No 1	EŞDEĞER NO 2 Equivalent No 2	ÖLÇÜLER MM. Dimensions-MM.					TİP Type	MALZEME Material
045948	TRAKTÖR SERİSİ Tractor Series	ŞANZ. KAVRAMA MİLİ Gearbox - Coupling Shaft	HL025110		12011147		35,00	62,00	-	7,00	-	L3TL	NBR
040484	MF 135-165-240-265-285	ŞANZIMAN ÖN 8 VİTES Gearbox Front - 8 Gear	186083M5	186083M3			41,15	49,42	-	6,35	-	L1L	NBR
040484-S	MF 165-240-265-285	ŞANZIMAN ÖN 8 VİTES Gearbox Front - 8 Gear	1860867M4	1860867M5-M1			41,15	49,42	-	6,35	-	L1L	VMQ
045609-P	TRAKTÖR SERİSİ Tractor Series	ŞANZIMAN ÖN Gearbox Front	3382237M1		12014056	19026746	45,00	62,00	-	10,00	-	L3 SAĞ -Right	ACM
045199	MF 135-165-240	ŞANZIMAN ARKA Gearbox Rear	195503M1		19032636		44,45	57,35	-	9,52	-	L3	NBR
040591	TRAKTÖR SERİSİ Tractor Series	ŞANZIMAN MİLİ Gearbox Shaft	3015264X1		12011111		16,00	28,00	-	7,00	-	L3L	NBR
041160	TRAKTÖR SERİSİ Tractor Series	ŞANZIMAN MİLİ Gearbox Shaft	3009856X1		12011114		20,00	30,00	-	7,00	-	L3	NBR
040117	TRAKTÖR SERİSİ Tractor Series	ŞANZIMAN MİLİ Gearbox Shaft	0080533U1				20,00	35,00	-	10,00	-	L3	NBR
040745	TRAKTÖR SERİSİ Tractor Series	ŞANZIMAN MİLİ Gearbox Shaft	1441802X1	HL011986	12011122		25,00	35,00	-	7,00	-	L3TL	NBR
040765	TRAKTÖR SERİSİ Tractor Series	ŞANZIMAN MİLİ Gearbox Shaft	3015189X1		12011131		30,00	40,00	-	7,00	-	L3L	NBR
045946	TRAKTÖR SERİSİ Tractor Series	ŞANZIMAN MİLİ Gearbox Shaft	HL025109		12011137		30,00	62,00	-	7,00	-	L3TL	NBR
040287	TRAKTÖR SERİSİ Tractor Series	ŞANZIMAN MİLİ-TURNER Gearbox Shaft - Turner Type	1440737X1		12000936		32,00	45,00	-	7,00	-	L3	NBR
045269	TRAKTÖR SERİSİ Tractor Series	ŞANZIMAN MİLİ Gearbox Shaft	3008780X1	973454M1	12010938	12000504	40,00	65,00	-	10,00	-	L3	NBR
045260	TRAKTÖR SERİSİ Tractor Series	ŞANZIMAN MİLİ Gearbox Shaft	0080156U1		12010977		52,00	72,00	-	10,00	-	L3	NBR
047229	TRAKTÖR SERİSİ Tractor Series	ŞANZIMAN MİLİ Gearbox Shaft	1442640X1		12014022		70,00	85,00	-	8,00	-	L3	NBR
4TP-021	TRAKTÖR SERİSİ Tractor Series	ŞANZIMAN TAPASI Gearbox Plug	3761376M1M				-	35,40	-	6,75	-	T3T	NBR
040138	MF 135-165-240	ŞANZ. KLM ÇIKIŞ MİLİ Speedometer Shaft	30854M-34058	636762M1			22,22	35,12	-	6,35	-	L3	NBR
045906	4x4 TRAKTÖR SERİSİ 4x4 Tractor Series	PTO KUYRUK MİLİ Power Take Off Shaft	HL024028		12011144	12010907	35,00	52,00	-	7,00	-	L3TL	NBR

## ŞANZIMAN GRUBU / Gearbox Group

SKT NO	KULLANILAN MODELLER Models	KULLANIM YERİ Place Of Use	ORJINAL NO 1 Orijinal No 1	ORJINAL NO 2 Orijinal No 2	EŞDEĞER NO 1 Equivalent No 1	EŞDEĞER NO 2 Equivalent No 2	ÖLÇÜLER MM. Dimensions-MM.					TİP Type	MALZEME Material
045224	TRAKTÖR SERİSİ Tractor Series	PTO KUYRUK MİLİ Power Take Off Shaft	973933M1		12010910		35,00	56,00	-	10,00	-	L3	NBR
045208	MF 135-165	PTO KUYRUK MİLİ Power Take Off Shaft	195506M1				44,45	68,35	-	15,87	19,44	L1L	NBR
047820	240-260-398-260G-3105-4WD	PTO KUYRUK MİLİ Power Take Off Shaft	3699801M1				60,30	79,40	-	15,50	16,60	SPSC2	NBR
047467	MF 135-165-240-265-285	PTO KUYRUK MİLİ Power Take Off Shaft	834216M1				60,33	79,47	-	9,92	-	L1L	NBR
047426	MF 240	PTO KUYRUK MİLİ Power Take Off Shaft	1860325M1				60,33	79,62	-	9,52	-	L3	NBR

## DİREKSİYON GRUBU / Steering Group

SKT NO	KULLANILAN MODELLER Models	KULLANIM YERİ Place Of Use	ORJINAL NO 1 Orijinal No 1	ORJINAL NO 2 Orijinal No 2	EŞDEĞER NO 1 Equivalent No 1	EŞDEĞER NO 2 Equivalent No 2	ÖLÇÜLER MM. Dimensions-MM.					TİP Type	MALZEME Material
4833-K	MF 135-165-240-265	DİREKSİYON MİLİ Steering Shaft	180355M1	183021M2			31,00	45,20	-	6,30	-	K	YÜN
040107	MF 135	DİREKSİYON MİLİ Steering Shaft	40107				31,75	44,55	-	6,35	-	L1	NBR
040047	TRAKTÖR SERİSİ Tractor Series	DİREKSİYON MİLİ Steering Shaft	975186M1	E1ADDN3539			35,00	47,00	-	7,00	-	L3	NBR
040957-V	MF 240	HİD.DİREKSİYON POMPASI Power Steering Pump	1810843				13,45	26,97	-	7,00	-	L13BL	FKM
040655-P	MF 285	HİD.DİREKSİYON POMPASI Power Steering Pump	1864308	1884308M1			17,46	28,75	-	6,35	-	L3	ACM
040490	MF 265-285	HİD.DİREKSİYON POMPASI Power Steering Pump	1864308	1884308M1			17,46	28,75	-	7,93	-	L3X	NBR
4TM-040	MF 165-240-265-285-4x4 SERİ	DİREKSİYON POMPASI YAN Hydraulic Pump	192-113A 1635948M92	1810509 1810417M91			-	-	-	-	-	TM	-
040708	MF 135-240-265	DİREKSİYON SEKTÖR MİLİ Steering Sector Shaft	1850019M1	022709038M			31,75	44,65	-	6,35	-	SPL3	NBR
045514	MF 165-285	DİREKSİYON SEKTÖR MİLİ Steering Sector Shaft	832398M1 1850519	1850519M91 9955111			38,10	51,00	-	5,55	-	L3	NBR
4TM-002	MF 165-240-285	HİDROLİK DİREKSİYON TM.TK. Power Steering Repair Kit	894969M1 1680010	3186708M91					-		-	TM	-
4TM-003	MF 165-240-286	HİDROLİK DİREKSİYON TM.TK. Power Steering Repair Kit	1606890M91				-	-	-	-	-	TM	-

## HİDROLİK GRUBU / Hydraulic Group

SKT NO	KULLANILAN MODELLER Models	KULLANIM YERİ Place Of Use	ORJINAL NO 1 Orijinal No 1	ORJINAL NO 2 Orijinal No 2	EŞDEĞER NO 1 Equivalent No 1	EŞDEĞER NO 2 Equivalent No 2	ÖLÇÜLER MM. Dimensions-MM.					TİP Type	MALZEME Material
4FM-123-CA	MF 285	HİDROLİK PİSTON TEFLONU Hydraulic Piston Teflon Ring	3761477M1				79,30	86,20	-	5,90	-	F	PTFE
4FM-118	398-3105	HİDROLİK PİSTON TEFLONU Hydraulic Piston Teflon Ring	3761476M1				90,94	94,15	-	6,08	-	F	PTFE
040466-V	MF 165-285	HİDROLİK POMPA Hydraulic Pump	1884308M1				17,46	30,25	-	7,93	-	L3BL	FKM
040537	MF 165	HİDROLİK POMPA Hydraulic Pump	2P13000020	2P1.3000.020			22,22	38,17	-	9,52	-	L1BL	NBR
045936	TRAKTÖR SERİSİ Tractor Series	HİDROLİK POMPA Hydraulic Pump	HL023692				60,00	75,00	-	8,00	-	L3BTL	NBR
4TM-019	TRAKTÖR SERİSİ Tractor Series	HİDR.POMPA TAM.TAK. Hydraulic Pump Repair Kit	402801588M	8281576			-	-	-	-	-	TM	-
4TM-048	MF 2PI POMPALAR	HİDR.POMPA TAM.TAK. Hydraulic Pump Repair Kit	2PI				-	-	-	-	-	TM	-
045543	TRAKTÖR SERİSİ Tractor Series	HİD. KALDIRMA SİSTEMİ Hydraulic Lifting System	1442216X1		12010981		55,00	70,00	-	8,00	-	L3	NBR



## MOTOR GRUBU / Engine Group

SKT NO	KULLANILAN MODELLER Models	KULLANIM YERİ Place Of Use	ORJINAL NO 1 Orijinal No 1	ORJINAL NO 2 Orijinal No 2	EŞDEĞER NO 1 Equivalent No 1	EŞDEĞER NO 2 Equivalent No 2	ÖLÇÜLER MM. Dimensions-MM.					TİP Type	MALZEME Material
045850-V	450-480-640-54C-55/46-65/46-60/74-82/81	KRANK ÖN Crank Shaft Front	98488391 99469265	99469265 40000010	12014859		42,00	65,00	-	10,00	-	L13T SAĞ -Right	FKM
045537-S	450-480-640-54C-55/46-65/46-70/56	KRANK ÖN Crank Shaft Front	40000010	7151917	12011460	12013479	42,00	65,00	-	12,00	-	L1L SAĞ -Right	VMQ
045537-V	450-480-640-54C-55/46-65/46-70/56	KRANK ÖN Crank Shaft Front	40000010		12011460	12013479	42,00	65,00	-	12,00	-	L1L SAĞ -Right	FKM
046145-V	JX60 JX70 JX90 JX95	KRANK ÖN Crank Shaft Front	84478262 98488391	84478264-40101330 40101333-98461684	12013479 12011460	01026318	42,00	65,00	-	12,00	-	L13TL SAĞ -Right	FKM
045151	FIAT 415	KRANK ÖN Crank Shaft Front	582505				55,00	72,00	-	10,00	-	L3	NBR
045151-V	415-TRAKTÖR SERİSİ	KRANK ÖN Crank Shaft Front	4589556 4634505	582505 215101290	12010983		55,00	72,00	-	10,00	-	L3	FKM
047498-S	TRAKTÖR SERİSİ Tractor Series	KRANK ÖN Crank Shaft Front	3228401R91	3085309R91 3136881R92	12011821		80,00	100,00	-	13,00	-	L1L SAĞ -Right	VMQ
410219-S	450-480-640	KRANK ARKA Crank Shaft Rear	40000720		12011314		95,00	120,00	-	13,00	-	L1L SOL -Left	VMQ
410219-V	450-480-640	KRANK ARKA Crank Shaft Rear	40000720		12011314		95,00	120,00	-	13,00	-	L1L SOL -Left	FKM
412189-S	TRAKTÖR SERİSİ Tractor Series	KRANK ARKA Crank Shaft Rear	46123797	46139353	12012521		110,00	130,00	-	13,00	-	L1L SOL -Left	VMQ
412189-V	TRAKTÖR SERİSİ Tractor Series	KRANK ARKA Crank Shaft Rear	46123797	46139353	12012521		110,00	130,00	-	13,00	-	L1L SOL -Left	FKM
412176-S	450-480-640	KRANK ARKA Crank Shaft Rear	40002810 40001800	40002811	12011317		110,00	135,00	-	13,00	-	L1L SOL -Left	VMQ
412176-V	450-480-640	KRANK ARKA Crank Shaft Rear	40002810 40002811	40001800 4000281	12011317		110,00	135,00	-	13,00	-	L1L SOL -Left	FKM
412235-S	450-480-640-54C*65/46-70/56 SERİSİ	KRANK ARKA Crank Shaft Rear	40003800 40101341	98461686 99457401	12016274	12014858	114,00	135,00	-	13,00	-	L1L SOL -Left	VMQ
412235-V	450-480-640-54C*65/46-70/56 SERİSİ	KRANK ARKA Crank Shaft Rear	40003800 98488392	40101341 40100880	12011318	12016274	114,00	135,00	-	13,00	-	L1L SOL -Left	FKM
412281-V	TRAKTÖR SERİSİ Tractor Series	KRANK ARKA Crank Shaft Rear	40003800 98488392	504127327 99457401	12016274	12011818	114,00	135,00	-	13,00	-	L13TL SOL -Left	FKM
412374-V	TRAKTÖR SERİSİ Tractor Series	KRANK ARKA Crank Shaft Rear	504127327		12016274		114,00	135,00	-	13,00	-	L3L SOL -Left	FKM
412233-V	M115-M135-M160	KRANK ARKA Crank Shaft Rear	83955247	3954247	15017000	15011274	122,23	141,12	-	11,90	-	L3SOL	FKM
412397-V	TRAKTÖR SERİSİ Tractor Series	KRANK ARKA Crank Shaft Rear	40002650	40101400	12015746		125,00	150,00	-	13,00	-	L13TL SOL	FKM

# NEW HOLLAND - FIAT

## MOTOR GRUBU / Engine Group

SKT NO	KULLANILAN MODELLER Models	KULLANIM YERİ Place Of Use	ORJINAL NO 1 Orijinal No 1	ORJINAL NO 1 Orijinal No 2	EŞDEĞER NO 1 Equivalent No 1	EŞDEĞER NO 1 Equivalent No 2	ÖLÇÜLER MM. Dimensions-MM.					TİP Type	MALZEME Material
415208-V	TRAKTÖR SERİSİ Tractor Series	KRANK ARKA Crank Shaft Rear	98494987		12031045		140,00	165,00	-	13,00	-	L13TL SOL-Left	FKM
415108-S	TRAKTÖR SERİSİ Tractor Series	KRANK ARKA Crank Shaft Rear	40100601		12011323		140,00	165,00	-	15,00	-	L1L SOL-Left	VMQ
45-030-V	54 C-55/46-65/46-70/56-TT-TD SERİSİ	SUPAP Valve Stem Seal	5098145	4830224			8,00	12,00	15,25	7,00	9,50	LSY2T	FKM
45-051-V	TRAKTÖR SERİSİ Tractor Series	SUPAP Valve Stem Seal	4830224		12015512 49472894	761.389 104.384	8,00	12,00	15,00	6,00	9,50	LSY2T	FKM
45-041-V	TRAKTÖR SERİSİ 55/56-TD85 Tractor Series	SUPAP Valve Stem Seal	4830224		12015512 49472894	761.389 104.384	8,00	12,00	15,50	6,75	9,50	LSY4T	FKM
040760	TRAKTÖR SERİSİ Tractor Series	YAKIT POMPASI Fuel Pump	79071380	93160144	82019584	82019584	20,00	31,00	-	7,00	-	L1B	NBR
040146	TRAKTÖR SERİSİ Tractor Series	YAKIT POMPASI Fuel Pump	350358348		12010825		20,00	35,00	-	7,00	-	L3	NBR
045361	TRAKTÖR SERİSİ Tractor Series	SU POMPASI Water Pump	350358306 44078737	44882295 9926528	12010908		35,00	52,00	-	10,00	-	L3L	NBR
041049-V	TRAKTÖR SERİSİ Tractor Series	KOMPRESÖR MİLİ Compressor Shaft	79043163		12011676		28,00	47,00	-	7,00	-	L3 SS-RL	FKM
041330-F	TRAKTÖR SERİSİ Tractor Series	BORG WAGNER TERMOSTAT Thermostat Body	98494952- 26352.05		-	-	35,00	44,00	-	6,50		SPF	PTFE

## AKS ve DİFERANSİYEL GRUBU / Axle and Differential Group

SKT NO	KULLANILAN MODELLER Models	KULLANIM YERİ Place Of Use	ORJINAL NO 1 Orijinal No 1	ORJINAL NO 1 Orijinal No 2	EŞDEĞER NO 1 Equivalent No 1	EŞDEĞER NO 1 Equivalent No 2	ÖLÇÜLER MM. Dimensions-MM.					TİP Type	MALZEME Material
045449	TRAKTÖR SERİSİ Tractor Series	ÖN AKS Front Axle	40000780		12011501		40,00	57,15	-	10,00	-	L1	NBR
046185	TT50-TT55	ÖN AKS Front Axle	5090485				44,00	74,00	-	10,00	-	CL2L	NBR
047770-K	480-640-54C	ÖN AKS Front Axle	4971457				44,00	80,00	-	13,00	-	SK2	YÜN
046075-NL	TT-TD SERİSİ	ÖN AKS Front Axle	5184123 5184124	5172329 87521513	12015734		47,00	65,00	-	16,50	-	KOMBI 1X	NBR+TPU
046203-VL	TRAKTÖR SERİSİ Tractor Series	ÖN AKS Front Axle	85821287		12017310		48,00	65,00	-	16,50	-	KOMBI 1X	FKM+TPU
046070	TD 65D/75D/85D/95D	ÖN AKS Front Axle	5090135				50,00	74,00	-	10,00	-	CL2L	NBR

## AKS ve DİFERANSİYEL GRUBU / Axle and Differential Group

SKT NO	KULLANILAN MODELLER Models	KULLANIM YERİ Place Of Use	ORJINAL NO 1 Orijinal No 1	ORJINAL NO 2 Orijinal No 2	EŞDEĞER NO 1 Equivalent No 1	EŞDEĞER NO 2 Equivalent No 2	ÖLÇÜLER MM. Dimensions-MM.					TİP Type	MALZEME Material
046128-NK	TRAKTÖR SERİSİ Tractor Series	ÖN AKS Front Axle	353587178		12012503		50,00	75,00	-	12,00	-	KOMBI 3	NBR+YÜN
047585-K	480-540-640	ÖN AKS Front Axle	158244	4951077			50,00	80,00	-	11,00	-	CSPSK	YÜN
047771-K	FIAT 450 48 HP	ÖN AKS Front Axle	561956				50,00	82,00	-	10,00	11,00	SK2	YÜN
047769-K	55/46-65/46-70/56	ÖN AKS Front Axle	4951077				50,00	82,00	-	12,00	-	SK2	YÜN
047922-VN	TRAKTÖR SERİSİ Tractor Series	ÖN AKS Front Axle	85825034		12018849		65,00	92,00	-	10,00	15,00	SC6	FKM+NBR
410404-NL	65-46-70/56-TD-TT SERİSİ	ÖN AKS Front Axle	90352915		12001910		90,00	120,00		13,00		KOMBI 3	NBR+TPU
417132	4x4 TRAKTÖR SERİSİ 4x4 Tractor Series	ÖN AKS Front Axle	1349265C1	83996064	12013126		150,00	176,00	-	15,50	16,00	SC6	NBR
417117	70-56/TDSEİLERİ	ÖN AKS Front Axle	5177708	5184116	12015134		165,00	190,00	-	15,50	17,00	SC6	NBR
417120	JX90 JX95 TIERİJXU 85 JX80	ÖN AKS Front Axle	87309584	84251055 91868559	12019930		165,00	190,00	-	15,50	-	SC6-SS-RL	NBR
420074	TRAKTÖR SERİSİ Tractor Series	ÖN AKS Front Axle	5178141 5183488	5183844 86027229	12015136		190,00	220,00	-	16,00	18,00	SC6	NBR
046208-NK	4x4 TRAKTÖR SERİSİ 4x4 Tractor Series	ÖN AKS İÇ Front Axle Inner	83952335	9968001	12001889		42,00	62,00	-	14,00	-	KOMBI 3	NBR+YÜN
4TM-087	TRAKTÖR SERİSİ Tractor Series	ÖN AKS TM.TAKIMI Front Axle Repair Kit	84480070				-	-	-	-	-	TM	-
041298	TRAKTÖR SERİSİ Tractor Series	ÖN AKS DİFERANSİYEL Front Axle-Differential	5135386	90393090 8428825M1	12001878		30,00	42,00	-	14,00	-	KOMBI 4	NBR
041252-NL	TRAKTÖR SERİSİ Tractor Series	ÖN AKS DİFERANSİYEL Front Axle-Differential	5194162		12013519	12018617	30,00	44,00	-	14,00	-	KOMBI 1X	NBR+TPU
046199-NK	TRAKTÖR SERİSİ Tractor Series	ÖN AKS DİFERANSİYEL Front Axle-Differential	5194291	9968020 3428521	12001882		35,00	52,00	-	16,00	-	KOMBI 3	NBR-YÜN
045665	TRAKTÖR SERİSİ Tractor Series	ÖN AKS DİFERANSİYEL Front Axle-Differential	5116701		12011146		35,00	55,00	-	11,00	-	L3L	NBR
046298-NK	TRAKTÖR SERİSİ Tractor Series	ÖN AKS DİFERANSİYEL Front Axle-Differential	85807964		12001886		40,00	55,00	-	10,00	-	KOMBI 3	NBR+YÜN
046142-NL	110-90	ÖN AKS DİFERANSİYEL Front Axle-Differential	85821295		12013465		40,00	60,00	-	18,50	-	KOMBI 1X	NBR+TPU
046042	70/56-80/95-66/TD- 65D/75D/85D/95D	ÖN AKS DİFERANSİYEL Front Axle-Differential	5133799	539719	12001890		42,00	62,00	-	17,00	-	KOMBI 4	NBR+YÜN+TPU

# NEW HOLLAND - FIAT

## AKS ve DİFERANSİYEL GRUBU / Axle and Differential Group

SKT NO	KULLANILAN MODELLER Models	KULLANIM YERİ Place Of Use	ORJINAL NO 1 Orijinal No 1	ORJINAL NO 1 Orijinal No 2	EŞDEĞER NO 1 Equivalent No 1	EŞDEĞER NO 1 Equivalent No 2	ÖLÇÜLER MM. Dimensions-MM.					TİP Type	MALZEME Material
046297-NL	TRAKTÖR SERİSİ Tractor Series	ÖN AKS DİFERANSİYEL Front Axle-Differential	5177709	5184118	12016507		42,00	62,00	-	21,50	-	KOMBI 1X	NBR-TPU
046300-NK	TRAKTÖR SERİSİ Tractor Series	ÖN AKS DİFERANSİYEL Front Axle-Differential	85805991		12011969		45,00	65,00	-	12,00	-	KOMBI 3	NBR+YÜN
046107-NL	110-90	ÖN AKS DİFERANSİYEL Front Axle-Differential	5135990		12001894		45,00	65,00	-	15,00	-	KOMBI 4	NBR+TPU
046202-NL	TRAKTÖR SERİSİ Tractor Series	ÖN AKS DİFERANSİYEL Front Axle-Differential	5169122	5183845 9840518	12012377		45,00	65,00	-	18,50	-	KOMBI 1X	NBR+TPU
046073	4x4 TRAKTÖR SERİSİ 4x4 Tractor Series	ÖN AKS DİFERANSİYEL Front Axle-Differential	5135294	5106065	12000514		45,00	75,00	-	10,00	8,00	L3L	NBR
046072	65/46-70/56-TD-T SERİSİ	ÖN AKS DİFERANSİYEL Front Axle-Differential	5122548	83944350 5105932	12006467		50,00	62,00	-	5,00	7,00	L5L	NBR
046223-NL	4x4 TRAKTÖR SERİSİ 4x4 Tractor Series	ÖN AKS DİFERANSİYEL Front Axle-Differential	87330293		12014048		50,00	72,00	-	16,50	-	KOMBI 1X	NBR+TPU
046071	80-66 / 95-66 / TD- 75D/85D/95D	ÖN AKS DİFERANSİYEL Front Axle-Differential	5121471		12006469		56,00	70,00	-	8,00	10,00	L5L	NBR
047920-NL	TRAKTÖR SERİSİ Tractor Series	ÖN AKS DİFERANSİYEL Front Axle-Differential	9967730		12001902		58,00	82,00	-	15,00	-	KOMBI 1X	NBR+TPU
047896-NK	4x4 TRAKTÖR SERİSİ 4x4 Tractor Series	ÖN AKS DİFERANSİYEL Front Axle-Differential	5169970	87309584	12001903		65,00	92,00	-	14,00	-	KOMBI 3	NBR+YÜN
410404-NL	65-46-70/56-TD SERİSİ	ÖN AKS DİFERANSİYEL Front Axle-Differential	5135387		12001910		90,00	120,00	-	13,00	-	KOMBI 3	NBR+TPU
412159	TRAKTÖR SERİSİ Tractor Series	ÖN AKS DİFERANSİYEL Front Axle-Differential	5107808	20772463	12011367		125,00	150,00	-	13,00	-	L1L	NBR
415210-NL	TN F75/TT50/TT55/TT65	ÖN AKS DİFERANSİYEL Front Axle-Differential	5184122	5165155	12015132		130,00	154,00	-	18,00	-	KOMBI 1X	NBR+TPU
415220	TRAKTÖR SERİSİ Tractor Series	ÖN AKS DİFERANSİYEL Front Axle-Differential	47123727	85824344	12016448		130,00	160,00	-	14,50	16,00	SC6	NBR
417141-NK	TRAKTÖR SERİSİ Tractor Series	ÖN AKS DİFERANSİYEL Front Axle-Differential	5137109	5184116	12001925		165,00	190,00	-	17,00	-	KOMBI 3	NBR+YÜN
420069-NK	TRAKTÖR SERİSİ Tractor Series	ÖN AKS DİFERANSİYEL Front Axle-Differential	5133736		12001926		190,00	220,00	-	20,00	-	KOMBI 3	NBR+YÜN
045700	TRAKTÖR SERİSİ Tractor Series	DİFERANSİYEL SİSTEMİ Differential System	27342232	5105952	12011160		40,00	62,00	-	10,00	-	L3L	NBR
046076	TD 65D/75D/85D/95D	DİFERANSİYEL SİSTEMİ Differential System	84482108	5136002			40,00	62,00	-	10,00	7,00	L3L	NBR
045779	TRAKTÖR SERİSİ Tractor Series	DİFERANSİYEL SİSTEMİ Differential System	28106922	9579383	12011168		45,00	65,00	-	10,00	-	L3L	NBR

## AKS ve DİFERANSİYEL GRUBU / Axle and Differential Group

SKT NO	KULLANILAN MODELLER Models	KULLANIM YERİ Place Of Use	ORJINAL NO 1 Orijinal No 1	ORJINAL NO 2 Orijinal No 2	EŞDEĞER NO 1 Equivalent No 1	EŞDEĞER NO 2 Equivalent No 2	ÖLÇÜLER MM. Dimensions-MM.					TİP Type	MALZEME Material
046141-PL	TD-TT SERİSİ	DİFERANSİYEL SİSTEMİ Differential System	5172329	5184124 5184123	12015734		47,00	65,00	-	16,50	-	KOMBI 1X	ACM+TPU
045934	TRAKTÖR SERİSİ Tractor Series	DİFERANSİYEL SİSTEMİ Differential System	45482097	84032776	12011177		50,00	72,00	-	7,00	-	L3BTL	NBR
045229	TRAKTÖR SERİSİ Tractor Series	DİFERANSİYEL SİSTEMİ Differential System	44882009		12010971		50,00	72,00	-	10,00	-	L3	NBR
047689	TRAKTÖR SERİSİ Tractor Series	DİFERANSİYEL SİSTEMİ Differential System	84022860		12011780		50,00	90,00	-	10,00	-	L3TL	NBR
047746	TRAKTÖR SERİSİ Tractor Series	DİFERANSİYEL SİSTEMİ Differential System	412442	80412442	12010998		60,00	80,00	-	8,00	-	L3	NBR
047883	TRAKTÖR SERİSİ Tractor Series	DİFERANSİYEL SİSTEMİ Differential System	536079	5131495	12011196		65,00	90,00	-	10,00	-	L3L	NBR
047700	TRAKTÖR SERİSİ Tractor Series	DİFERANSİYEL SİSTEMİ Differential System	5124206		12011200	12011016	70,00	100,00	-	10,00	-	L3TL	NBR
046040-P	TT-TD SERİSİ	DİF.ÖN-MAHRUTİ Differential Front	5105997	40002790	12001577		30,00	62,00	-	10,00	-	SL	ACM
045785	TRAKTÖR SERİSİ Tractor Series	DİF.ÖN-MAHRUTİ Differential Front	5135294	5106065			45,00	75,00	-	12,00	-	L1L	NBR
047442	TC-56 BİÇERDÖVER	DİF.ÖN-MAHRUTİ Differential Front	40000521	558010			55,00	80,00	-	10,00	-	L1	NBR
047591	TRAKTÖR SERİSİ Tractor Series	DİF.ÖN-MAHRUTİ Differential Front	40000521		12011282		55,00	80,00	-	10,00	-	L1L	NBR
4TM-095	TRAKTÖR SERİSİ Tractor Series	DİFERANSİYEL KİLİDİ Differential Locking Sys.	84480071				-	-	-	-	-	TM	-
4TM-099	TRAKTÖR SERİSİ Tractor Series	DİFERANSİYEL KİLİDİ Differential Locking Sys.	47375790						-	-	-	TM	-
4TM-100	TRAKTÖR SERİSİ Tractor Series	DİFERANSİYEL KİLİDİ Differential Locking Sys.	47375794						-	-	-	TM	-
047101-V	TRAKTÖR SERİSİ Tractor Series	DİFR.GÜÇ AKT. MİLİ Diff.Transfer Shaft	5112246	4655211	12011188	12010988	55,00	90,00	-	10,00	-	L3	FKM
047812	70/56-80/95-66/TD- 65D/75D/85D/95D	ARKA AKS Rear Axle	5119215		12001650		50,00	80,00	-	8,00	-	L1	NBR
047375	411-415	ARKA AKS KOVAN Rear Axle	AL23547	AL38357			65,00	85,00	-	10,00	-	SL	NBR
047059	TRAKTÖR SERİSİ Tractor Series	ARKA AKS Rear Axle	375400	5152365	12011026	12002284	80,00	100,00	-	10,00	-	L3	NBR
410055	480-640-65/46-70/56-TT60-TT75	ARKA AKS Rear Axle	5106689				80,00	110,00	-	12,00	-	L3	NBR

# NEW HOLLAND - FIAT

## AKS ve DİFERANSİYEL GRUBU / Axle and Differential Group

SKT NO	KULLANILAN MODELLER Models	KULLANIM YERİ Place Of Use	ORJINAL NO 1 Orijinal No 1	ORJINAL NO 2 Orijinal No 2	EŞDEĞER NO 1 Equivalent No 1	EŞDEĞER NO 2 Equivalent No 2	ÖLÇÜLER MM. Dimensions-MM.					TİP Type	MALZEME Material
410405	TD65B/TD65D/TD60A/TD70A	ARKA AKS Rear Axle	5123370		12001908		80,00	110,00	-	16,00	-	KOMBI 3	NBR+TPU
410474	T450-T480-TD3-2WD-4WD	ARKA AKS Rear Axle	47444676				85,00	110,00	-	14,00	-	L3X	NBR
410449	TRAKTÖR SERİSİ Tractor Series	ARKA AKS Rear Axle	87387890	02132651 863562	12016635	12014974	85,00	110,00	-	14,50	-	SC6	NBR
410406	65/46-70/56-65/46	ARKA AKS Rear Axle	5131916		12001909		85,00	110,00	-	16,00	-	KOMBI 3	NBR
412278-NK	L95/TL100/T5040/T5050/T5060	ARKA AKS Rear Axle	5123205	5149310	12001912		100,00	130,00	-	16,00	-	KOMBI 3	NBR+YÜN
412159-V	TRAKTÖR SERİSİ Tractor Series	ARKA AKS Rear Axle	45663290	946093			125,00	150,00	-	13,00	-	L1L	FKM
410156	480-640-54c-65/46	ARKA AKS DIŞ Rear Axle Outer	28537222	148146 5085540			80,00	110,00	-	12,00	-	L1	NBR
410228	480-640-54c-65/46	ARKA AKS DIŞ Rear Axle Outer	28537222	853722 40001590	12011302	12011358	80,00	110,00	-	13,00	-	L1L	NBR
045538	55/46-65/46-70/56	ARKA AKS PORYA İÇ Rear Axle Inner	5085620	550589 5109074	12011525		45,00	72,00	-	10,00	-	L1	NBR
045614	450-480-640-54C	ARKA AKS PORYA İÇ Rear Axle Inner	550589 148150	5109074	12011525		45,00	72,00	-	10,00	-	L1L	NBR
045217	TRAKTÖR SERİSİ Tractor Series	ARKA AKS PORYA İÇ Rear Axle Inner	9955022	550589	12010959		45,00	72,00	-	10,00	-	L3	NBR
410332	TRAKTÖR SERİSİ Tractor Series	ARKA AKS PORYA İÇ Rear Axle Inner	353583259	28537222	12011029		80,00	110,00	-	12,00	-	L3L	NBR
4D-398	TRAKTÖR SERİSİ Tractor Series	ARKA AKS FREN MİLİ Rear Axle Brake Shaft	SM1810992				6,90	30,00	38,00	9,10	36,20	LS	NBR
4D-535-H	TT-TD SERİSİ	ARKA AKS FREN MİLİ Rear Axle Brake Shaft	47864244	5098381			12,50	43,15	58,00	12,00	56,50	LS	HNBR
4D-037	TRAKTÖR SERİSİ Tractor Series	ARKA AKS FREN MİLİ Rear Axle Brake Shaft	1860959	5117518			14,25	50,80	63,50	9,30	43,26	LS	NBR
045329	480 48 HP	ARKA AKS FREN MİLİ Rear Axle Brake Shaft	548274 595985	10015690	12011496		35,00	55,00	-	10,00	-	L1	NBR
045607	411-415	ARKA AKS FREN MİLİ Rear Axle Brake Shaft	595985	10015690	12011496		35,00	55,00	-	10,00	-	L3L	NBR
045329-P	480-640	ARKA AKS FREN MİLİ Rear Axle Brake Shaft	548274 595985	5105919 10015690	12011496		35,00	55,00	-	10,00	-	L1	ACM
045419	450-480-640-54C-55/46-65/46	ARKA AKS FREN MİLİ Rear Axle Brake Shaft	40001570 40000382	5085510	12011497		35,00	55,00	-	12,00	-	L1L	NBR

## AKS ve DİFERANSİYEL GRUBU / Axle and Differential Group

SKT NO	KULLANILAN MODELLER Models	KULLANIM YERİ Place Of Use	ORJINAL NO 1 Orijinal No 1	ORJINAL NO 2 Orijinal No 2	EŞDEĞER NO 1 Equivalent No 1	EŞDEĞER NO 2 Equivalent No 2	ÖLÇÜLER MM. Dimensions-MM.					TİP Type	MALZEME Material
046039	480-640-54C-55/46-65/46	ARKA AKS FREN MİLİ Rear Axle Brake Shaft	40001570	40000380	12011497		35,00	55,00	-	12,00	-	L1	NBR
045419	TRAKTÖR SERİSİ Tractor Series	ARKA AKS FREN MİLİ Rear Axle Brake Shaft	5085510	40001570	12011497		35,00	55,00	-	12,00	-	L1L	NBR
040290	480-640-54C-55/46-65/46	FREN SİSTEMİ Brake System	5085590 9955111	40001821	12010923		38,00	50,00	-	7,00	-	L3	NBR

## ŞANZİMAN GRUBU / Gearbox Group

SKT NO	KULLANILAN MODELLER Models	KULLANIM YERİ Place Of Use	ORJINAL NO 1 Orijinal No 1	ORJINAL NO 2 Orijinal No 2	EŞDEĞER NO 1 Equivalent No 1	EŞDEĞER NO 2 Equivalent No 2	ÖLÇÜLER MM. Dimensions-MM.					TİP Type	MALZEME Material
045448	TRAKTÖR SERİSİ Tractor Series	ŞANZİMAN ÖN Gearbox Front	40000050	21011005034	12011455		40,00	56,00	-	7,00	-	L1 SAĞ -Right	NBR
045120	TRAKTÖR SERİSİ Tractor Series	ŞANZİMAN ÖN Gearbox Front	40000010		19035561		42,00	65,00	-	10,00	12,00	L3L	NBR
045560	TRAKTÖR SERİSİ Tractor Series	ŞANZİMAN ÖN Gearbox Front	353583192 5144380	47210002 5123294	12017052		45,00	60,00	-	7,00	-	L3L	NBR
045696	80/95-66/TD65D/75D/85D/95D	ŞANZİMAN ÖN Gearbox Front	87608073 4721002	5144380 5123294	12017052		45,00	60,00	-	7,00	-	L3L SAĞ -Right	NBR
045696-P	TT-TD-80/95-66	ŞANZİMAN ÖN Gearbox Front	84209519 87608073	5144380 8123520	12017270		45,00	60,00	-	7,00	-	L3L SAĞ -Right	ACM
045696-V	TT-TD-80/95-66	ŞANZİMAN ÖN Gearbox Front	5144380 5123294	47210002 84209519	12001197	15014894	45,00	60,00	-	7,00	-	L3L SAĞ -Right	FPM
045609-P	TRAKTÖR SERİSİ Tractor Series	ŞANZİMAN ÖN Gearbox Front	40000270	40000271	12014056	19026746	45,00	62,00	-	10,00	-	L3 SAĞ -Right	ACM
045575	640-54C-65/46-70/56	ŞANZİMAN ÖN Gearbox Front	40000371	5085500 5105944	12011509		45,00	65,00	-	10,00	-	L1	NBR
045330	415	ŞANZİMAN ÖN Gearbox Front	180057 5085570	25570322 79007266	12011331	12000519	48,00	65,00	-	10,00	-	L1	NBR
046074-P	110-90/TL100-TT-TD-DT	ŞANZİMAN ÖN Gearbox Front	5106069		12011463		50,00	68,00	-	8,00	-	L1 SAĞ -Right	ACM
045338	450-480-640-54C-55/46-65/47	ŞANZİMAN ÖN Gearbox Front	128192 5085530	29740972 596450			53,00	68,00	-	10,00	-	L1L	NBR
046035	480 48 HP	ŞANZİMAN ÖN Gearbox Front	596450	5107908	12011427		53,00	68,00	-	10,00	-	L1	NBR
047746-V	TRAKTÖR SERİSİ Tractor Series	ŞANZİMAN ÖN Gearbox Front	5119765	0-025846	12000712		60,00	80,00	-	8,00	-	L3	FKM

# NEW HOLLAND - FIAT

## ŞANZIMAN GRUBU / Gearbox Group

SKT NO	KULLANILAN MODELLER Models	KULLANIM YERİ Place Of Use	ORJINAL NO 1 Original No 1	ORJINAL NO 2 Original No 2	EŞDEĞER NO 1 Equivalent No 1	EŞDEĞER NO 2 Equivalent No 2	ÖLÇÜLER MM. Dimensions-MM.					TİP Type	MALZEME Material
047354	TRAKTÖR SERİSİ Tractor Series	ŞANZIMAN ÖN Gearbox Front	83910773	83924159			66,67	92,15	-	11,11	-	SLL	NBR
045707-V	TT-TD SERİSİ	ŞANZIMAN-GÜÇ AKT. MİLİ Power Transfer Shaft	48160982				30,00	62,00	-	10,00	-	L3L	FKM
047712-V	110-90	HARAKET DİŞLİ MİLİ Gearbox Overgear Shaft	5129003 5112246	5105330 40000860	12000734		55,00	90,00	-	10,00	-	L3L	FKM
040477	450-480-640-54C-65/46	ŞANZIMAN ÖN-KAMALI MİL Gearbox Front-Spline Shaft	84226406 5085520	4985295 5179747	12014051		25,00	31,00	-	7,00	-	L2	ACM
040477-P	450-480-640-54C-65/46	ŞANZIMAN ÖN-KAMALI MİL Gearbox Front-Spline Shaft	84226406	5179747	12016753		25,00	31,00	-	7,00	-	L2	ACM
045948	TRAKTÖR SERİSİ Tractor Series	ŞANZ. KAVRAMA MİLİ Gearbox - Coupling Shaft	80357923		12011147		35,00	62,00	-	7,00	-	L3TL	NBR
046041-P	80/95-66/TD65D/75D/85D/95D	ŞANZ. İŞTİRAK DİŞLİSİ Gearbox - Overgear	5119206	84480072	12011392		30,00	72,00	-	10,00	-	SLL	ACM
047840-P	TD75D	ŞANZIMAN-KİLİT MİLİ Gearbox Lock Shaft	84482082	5150370	12013029		35,00	80,00	-	10,00	-	L3L	ACM
047840-V	TD75D	ŞANZIMAN-KİLİT MİLİ Gearbox Lock Shaft	47715403		12013029		35,00	80,00	-	10,00	-	L3L	FKM
045700-V	TRAKTÖR SERİSİ Tractor Series	ŞANZ. HAREKET ANA MİL Gearbox - Overgear	5136005	5105952	01019150		40,00	62,00	-	10,00	-	L3L	FKM
047712	TRAKTÖR SERİSİ Tractor Series	ŞANZ. İŞTİRAK DİŞLİSİ Gearbox - Overgear	5112246	5129003	12011188		55,00	90,00	-	10,00	-	L3L	NBR
046183-V	TRAKTÖR SERİSİ Tractor Series	PTO KUYRUK MİLİ Power Take Off Shaft	84482087 47970741	6E1572	01033941		55,00	70,00	-	7,00	8,00	L3BL	FKM
040149	TRAKTÖR SERİSİ Tractor Series	PTO KUYRUK MİLİ Power Take Off Shaft	5105887	0734300196	12011487		25,00	35,00	-	7,00	-	L3	NBR
040286-V	TRAKTÖR SERİSİ Tractor Series	PTO KUYRUK MİLİ Power Take Off Shaft	87528273		12001163		25,00	40,00	-	7,00	-	L3	FKM
046148	TT45 A / TT50 A	PTO KUYRUK MİLİ Power Take Off Shaft	87542755				42,00	72,00	-	8,00	-	L3	NBR
045216	640 64 HP	PTO KUYRUK MİLİ Power Take Off Shaft	29740762	5107905	12014077		42,00	72,00	-	10,00	-	L3	NBR
045331	450-480-640-54C-55/46-65/46	PTO KUYRUK MİLİ Power Take Off Shaft	180177 5085582	29740762	12014077		42,00	72,00	-	10,00	-	L1	NBR
046037	480-640-55/46-70/56	PTO KUYRUK MİLİ Power Take Off Shaft	29740762				42,00	72,00	-	10,00	-	L1L	NBR



## ŞANZIMAN GRUBU / Gearbox Group

SKT NO	KULLANILAN MODELLER Models	KULLANIM YERİ Place Of Use	ORJINAL NO 1 Orijinal No 1	ORJINAL NO 2 Orijinal No 2	EŞDEĞER NO 1 Equivalent No 1	EŞDEĞER NO 2 Equivalent No 2	ÖLÇÜLER MM. Dimensions-MM.					TİP Type	MALZEME Material
046038	640-65/46	PTO KUYRUK MİLİ Power Take Off Shaft	40000371	40000379 40000370	12001744		45,00	65,00	-	10,00	-	L1L	NBR
045702	54 C 55 HP	PTO KUYRUK MİLİ Power Take Off Shaft	135139 5086120	5125650 556163	12011331		48,00	65,00	-	10,00	-	L1L	NBR
047815-P	L95/TL100/T5040/T5050/ T5060/TD5010	PTO KUYRUK MİLİ Power Take Off Shaft	5165976 425354	025354 02226780	12019182	12011192	60,00	80,00	-	10,00	-	L3L	ACM
4TM-088	TRAKTÖR SERİSİ Tractor Series	PTO KUYRUK MİLİ TM.TK Power Take Off Repair Kit	84480069	84480041			-	-	-	-	-	TM	-
4FM-143-CA	TRAKTÖR SERİSİ Tractor Series	VİTES SEÇİCİ MİL Gear Selection Shaft	47513873				23,00	33,80		8,40		FM	PTFE
4MH-203	450-480-640-54C-55/46-65/46- 70/56	VİTES SEÇİCİ MİL Gear Selection Shaft	4984223	129195			23,00	40,50	-	9,50	-	LS	NBR
040447	450 48 HP	DEBRİYAJ SİSTEMİ Clutch System	5085520	000042800	12010832		20,00	47,00	-	10,00	-	L3L	NBR
047814-P	140-90 / M115 / M135 / TL100	DEBRİYAJ SİSTEMİ Clutch System	5122845	4655211	12001751		55,00	90,00	-	10,00	8,00	L1L	ACM
040591	TRAKTÖR SERİSİ Tractor Series	ŞANZIMAN MİLİ Gearbox Shaft	9955818		12011111		16,00	28,00	-	7,00	-	L3L	NBR
041005-V	TRAKTÖR SERİSİ Tractor Series	ŞANZIMAN MİLİ Gearbox Shaft	84179929				18,00	28,00	-	7,00	-	L3TL	FKM
040434	TRAKTÖR SERİSİ Tractor Series	ŞANZIMAN MİLİ Gearbox Shaft	5124750		12000623		22,00	28,00	-	4,00	-	L2	NBR
041175	TRAKTÖR SERİSİ Tractor Series	ŞANZIMAN MİLİ Gearbox Shaft	81864541		01031611		25,00	33,00	-	6,00	-	L3	NBR
040756	TRAKTÖR SERİSİ Tractor Series	ŞANZIMAN MİLİ Gearbox Shaft	44908438		12011130		28,00	47,00	-	7,00	-	L3L	NBR
040765	TRAKTÖR SERİSİ Tractor Series	ŞANZIMAN MİLİ Gearbox Shaft	353583118		12011131		30,00	40,00	-	7,00	-	L3L	NBR
040761	TRAKTÖR SERİSİ Tractor Series	ŞANZIMAN MİLİ Gearbox Shaft	44908438		12000480		30,00	47,00	-	7,00	-	L3TL	NBR
045946	TRAKTÖR SERİSİ Tractor Series	ŞANZIMAN MİLİ Gearbox Shaft	1332 417722	80417722	12011137		30,00	62,00	-	7,00	-	L3TL	NBR
040047	TRAKTÖR SERİSİ Tractor Series	ŞANZIMAN MİLİ Gearbox Shaft	81803055		12010904		35,00	47,00	-	7,00	-	L3	NBR
045254	TRAKTÖR SERİSİ Tractor Series	ŞANZIMAN MİLİ Gearbox Shaft	44902474		12010914		35,00	62,00	-	10,00	-	L3	NBR

# NEW HOLLAND - FIAT

## ŞANZİMAN GRUBU / Gearbox Group

SKT NO	KULLANILAN MODELLER Models	KULLANIM YERİ Place Of Use	ORJINAL NO 1 Orijinal No 1	ORJINAL NO 1 Orijinal No 2	EŞDEĞER NO 1 Equivalent No 1	EŞDEĞER NO 1 Equivalent No 2	ÖLÇÜLER MM. Dimensions-MM.					TİP Type	MALZEME Material
045405	TRAKTÖR SERİSİ Tractor Series	ŞANZİMAN MİLİ Gearbox Shaft	353583182		12010940		40,00	72,00	-	10,00	-	L3	NBR
045037	TRAKTÖR SERİSİ Tractor Series	ŞANZİMAN MİLİ Gearbox Shaft	83928261		01031949		50,80	69,95	-	12,70	-	SL	NBR
047816-P	TD-DT-D-TD4 SERİSİ	ŞANZİMAN MİLİ Gearbox Shaft	5119203	5105986	12000733		55,00	80,00	-	10,00	8,00	L3L	ACM
047229	TRAKTÖR SERİSİ Tractor Series	ŞANZİMAN MİLİ Gearbox Shaft	151208750		12014022		70,00	85,00	-	8,00	-	L3	NBR
047343	TRAKTÖR SERİSİ Tractor Series	ŞANZİMAN MİLİ Gearbox Shaft	40002320	5105331 76040608	12011533	01002684	70,00	90,00	-	10,00	-	L1	NBR
047343-V	TRAKTÖR SERİSİ Tractor Series	ŞANZİMAN MİLİ Gearbox Shaft	40002320	5105331 581968	12011533	01002684	70,00	90,00	-	10,00	-	L1	FKM
047104	TRAKTÖR SERİSİ Tractor Series	ŞANZİMAN MİLİ Gearbox Shaft	28430752		12011021		75,00	100,00	-	10,00	-	L3	NBR

82

## DİREKSİYON GRUBU / Steering Group

SKT NO	KULLANILAN MODELLER Models	KULLANIM YERİ Place Of Use	ORJINAL NO 1 Orijinal No 1	ORJINAL NO 1 Orijinal No 2	EŞDEĞER NO 1 Equivalent No 1	EŞDEĞER NO 1 Equivalent No 2	ÖLÇÜLER MM. Dimensions-MM.					TİP Type	MALZEME Material
040084	TRAKTÖR SERİSİ Tractor Series	DİREKSİYON MİLİ Steering Shaft	25450612		12010828		20,00	42,00	-	7,00	-	L3	NBR
040847	TRAKTÖR SERİSİ Tractor Series	DİREKSİYON MİLİ Steering Shaft	767755		12011123		25,00	40,00	-	7,00	-	L3BTL	NBR
040258	450-480-640-54C-55/46-65/46	DİREKSİYON MİLİ Steering Shaft	4509873				34,92	46,58	-	7,14	-	L3	NBR
046036	480-640-54C-65/46	DİREKSİYON MİLİ Steering Shaft	9955110				37,00	51,00	-	5,00	-	L3	NBR
047544-V	TRAKTÖR SERİSİ Tractor Series	DİREKSİYON KUTUSU Steering Box	5119566		12016817		75,00	100,00	-	10,00	-	L3L	FKM

## HİDROLİK GRUBU / Hydraulic Group

SKT NO	KULLANILAN MODELLER Models	KULLANIM YERİ Place Of Use	ORJINAL NO 1 Orijinal No 1	ORJINAL NO 2 Orijinal No 2	EŞDEĞER NO 1 Equivalent No 1	EŞDEĞER NO 2 Equivalent No 2	ÖLÇÜLER MM. Dimensions-MM.					TİP Type	MALZEME Material
4MH-418	TRAKTÖR SERİSİ Tractor Series	HİDROLİK SİSTEMİ Hydraulic System	84336253				14,00	25,40	-	6,00	-	L	NBR
4FM-127	T3 SERİSİ	HİDROLİK PİSTON TEFLONU Hydraulic Piston Teflon Ring	84364285				22,15	30,00	-	4,00	-	F	PTFE
040978-L	80/95-66/TD65D/75D/85D/95D	HİDROLİK KAYDIRICI MİL- Flexibar	47129342	5121123	19036935		23,00	38,00	-	12,30	-	LI	TPU-BEYAZ TPU+White
041209-L	80/95-66/TD65D/75D/85D/95D	HİDROLİK KAYDIRICI MİL- Flexibar	47129342		19036935		23,00	38,00	-	12,30	-	LI	TPU-KIRMIZI TPU+Red
041053-L	110 SERİSİ-TD65D/75D/85D/95D	HİDROLİK KAYDIRICI MİL- Flexibar	47129340				27,70	42,60	-	13,80	-	L1L	TPU-BEYAZ TPU+White
041218-L	TRAKTÖR SERİSİ Tractor Series	HİDROLİK KAYDIRICI MİL- Flexibar	47129340		-	-	27,70	42,60	-	13,80	-	L1L	TPU-KIRMIZI TPU+Red
046055-V	TRAKTÖR SERİSİ Tractor Series	HİDROLİK SİSTEMİ Hydraulic System	48160970				30,00	72,00		10,00	L3TL		FKM
4MH-422-F	TRAKTÖR SERİSİ Tractor Series	HİDROLİK SİSTEMİ Hydraulic System	84245728				57,00	62,00	-	4,00	-	L	PTFE
4TM-070	140-90/ M135	HİDROLİK KAYDIRICI MİL- Flexibar	5131746				-	-	-	-	-	TM	-
4TM-066	70-56 70 HP	HİDROLİK KAYDIRICI MİL- Flexibar	47124792	5121123			-	-	-	-	-	TM	-
040725	TRAKTÖR SERİSİ Tractor Series	HİDROLİK POMPA Hydraulic Pump	29740112		12010795		15,00	32,00	-	7,50	-	SPL3L	NBR
040281	450-480-640-54C	HİDROLİK POMPA Hydraulic Pump	5110478	8273910			17,00	28,00	-	7,00	-	L1	NBR
040503	480-640	HİDROLİK POMPA Hydraulic Pump	8273910				17,00	28,50	-	7,00	-	L3	NBR
040975	54C-55/46-65/46-70/56	HİDROLİK POMPA Hydraulic Pump	5110478				17,00	30,00	-	8,00	-	L1BL	NBR
040536	TRAKTÖR SERİSİ Tractor Series	HİDROLİK POMPA Hydraulic Pump	80354120		12016519		35,00	42,00	-	4,00	-	L5	NBR
4TM-019	480-540-640	HİDROLİK POMPA TAM.TAK. Hydraulic Pump Repair Kit	8281576A	402801588M					-		-	TM	-
045150	54C-65/46	HİDROLİK KOL MİLİ Hydraulic Arm Shaft	4051364	5086120	12000519 12010963		48,00	65,00	-	10,00	-	L3	NBR
045770	450-480-640-54C-55/46-65/46- 70/56	HİD. KALDIRMA SİSTEMİ Hydraulic Lifting System	5125650 5086120	182821 5086120	12000519		48,00	65,00	-	10,00	-	L3L	NBR

# NEW HOLLAND - FIAT

## HİDROLİK GRUBU / Hydraulic Group

SKT NO	KULLANILAN MODELLER Models	KULLANIM YERİ Place Of Use	ORJINAL NO 1 Orijinal No 1	ORJINAL NO 2 Orijinal No 2	EŞDEĞER NO 1 Equivalent No 1	EŞDEĞER NO 2 Equivalent No 2	ÖLÇÜLER MM. Dimensions-MM.					TİP Type	MALZEME Material
045822	95-66/110-90/L95/ TD SERİSİ	HİD. KALDIRMA SİSTEMİ Hydraulic Lifting System	5159078 046705	84482085	1201182		55,00	70,00	-	8,00	-	L3L	NBR
047858-V	BİÇERDÖVER Combine Harvester	HELEZON MİLİ Helical Shaft	87610910				45,00	85,00	-	10,00	-	L3LSS-RL	FKM

## DİĞER GRUPLAR / Others Group

SKT NO	KULLANILAN MODELLER Models	KULLANIM YERİ Place Of Use	ORJINAL NO 1 Orijinal No 1	ORJINAL NO 2 Orijinal No 2	EŞDEĞER NO 1 Equivalent No 1	EŞDEĞER NO 2 Equivalent No 2	ÖLÇÜLER MM. Dimensions-MM.					TİP Type	MALZEME Material
040343	TRAKTÖR SERİSİ Tractor Series	MİL KEÇESİ Shaft Seal	23912		12010822		20,00	30,00	-	5,00	-	L3	NBR
045944	TRAKTÖR SERİSİ Tractor Series	MİL KEÇESİ Shaft Seal	44908421		12011126	12010860	25,00	52,00	-	7,00	-	L3TL	NBR
045389	TRAKTÖR SERİSİ Tractor Series	MİL KEÇESİ Shaft Seal	546022		12010886		30,00	52,00	-	8,00	-	L3	NBR
047546	TRAKTÖR SERİSİ Tractor Series	MİL KEÇESİ Shaft Seal	23467		12011162		40,00	80,00	-	10,00	-	L3L	NBR
045059	TRAKTÖR SERİSİ Tractor Series	MİL KEÇESİ Shaft Seal	44881695		12010944		42,00	60,00	-	10,00	-	L3	NBR
045932	TRAKTÖR SERİSİ Tractor Series	MİL KEÇESİ Shaft Seal	151209181		12000518		47,00	62,00	-	7,00	-	L3BTL	NBR
045973	TRAKTÖR SERİSİ Tractor Series	MİL KEÇESİ Shaft Seal	5162255		01012190		50,00	58,00	-	4,00	-	L2	NBR
047310	TRAKTÖR SERİSİ Tractor Series	MİL KEÇESİ Shaft Seal	80552118		12011193		60,00	85,00	-	10,00	-	L3	NBR
047450	TRAKTÖR SERİSİ Tractor Series	MİL KEÇESİ Shaft Seal	40001990		12011007	12011008	65,00	85,00	-	10,00	-	L3	NBR

## DİĞER GRUPLAR / Others Group

SKT NO	KULLANILAN MODELLER Models	KULLANIM YERİ Place Of Use	ORJINAL NO 1 Orijinal No 1	ORJINAL NO 2 Orijinal No 2	EŞDEĞER NO 1 Equivalent No 1	EŞDEĞER NO 2 Equivalent No 2	ÖLÇÜLER MM. Dimensions-MM.					TİP Type	MALZEME Material
047219	TRAKTÖR SERİSİ Tractor Series	MİL KEÇESİ Shaft Seal	80536079		12011009		65,00	90,00	-	10,00	-	L3	NBR
047049	TRAKTÖR SERİSİ Tractor Series	MİL KEÇESİ Shaft Seal	5105351		12011015		70,00	90,00	-	10,00	-	L3	NBR
047544	TRAKTÖR SERİSİ Tractor Series	MİL KEÇESİ Shaft Seal	80384548		12011203		75,00	100,00	-	10,00	-	L3L	NBR
410052	TRAKTÖR SERİSİ Tractor Series	MİL KEÇESİ Shaft Seal	79053144		12000542		75,00	110,00	-	12,00	-	L3	NBR
410299	TRAKTÖR SERİSİ Tractor Series	MİL KEÇESİ Shaft Seal	80750298		12011826		90,00	110,00	-	10,00	-	L3L	NBR
412100	TRAKTÖR SERİSİ Tractor Series	MİL KEÇESİ Shaft Seal	45482136		12011210		105,00	130,00	-	13,00	-	L3	NBR
412196	TRAKTÖR SERİSİ Tractor Series	MİL KEÇESİ Shaft Seal	40001030		12011364		110,00	130,00	-	12,00	-	L1L	NBR
412101	TRAKTÖR SERİSİ Tractor Series	MİL KEÇESİ Shaft Seal	5109079		12011070		115,00	140,00	-	13,00	-	L3	NBR
415018	TRAKTÖR SERİSİ Tractor Series	MİL KEÇESİ Shaft Seal	151208320		12011076		120,00	160,00	-	12,00	-	L3	NBR
415006	TRAKTÖR SERİSİ Tractor Series	MİL KEÇESİ Shaft Seal	80381856		12011082		130,00	160,00	-	12,00	-	L3	NBR
0417121	TRAKTÖR SERİSİ Tractor Series	MİL KEÇESİ Shaft Seal	353587179		12013074		170,00	190,00	-	15,00	-	KOMBI 3	NBR
417045	TRAKTÖR SERİSİ Tractor Series	MİL KEÇESİ Shaft Seal	79085139		12011379		180,00	200,00	-	15,00	-	L1L	NBR

# PERKINS Motor / Engine

## MOTOR GRUBU / Engine Group

SKT NO	KULLANILAN MODELLER Models	KULLANIM YERİ Place Of Use	ORJINAL NO 1 Orijinal No 1	ORJINAL NO 2 Orijinal No 2	EŞDEĞER NO 1 Equivalent No 1	EŞDEĞER NO 2 Equivalent No 2	ÖLÇÜLER MM. Dimensions-MM.					TİP Type	MALZEME Material
047588-V	DİZEL MOT. Diesel Motor	KRANK ÖN Crank Shaft Front	2415344M1	2415343 AR67942	12014983		57,15	76,45	-	9,52	11,11	L3L SAĞ -Right	FKM
047558-V	DİZEL MOT. Diesel Motor	KRANK ÖN Crank Shaft Front	2418F436	2415361	12014981		60,33	79,62	-	9,52	11,11	L3L SAĞ -Right	FKM
047894-V	DİZEL MOT. Diesel Motor	KRANK ÖN Crank Shaft Front	2415361	2418F437	12014981	578.010	60,33	79,63	-	9,33	11,23	L3TL SAĞ -Right	FKM
420056-VAE	DİZEL MOT. Diesel Motor	KRANK ARKA Crank Shaft Rear	2418F701	4224532M1	20031744		133,30	197,00	219,00	24,00	-	SPL1L SOL -Left	FKM+AEM
415171-V	DİZEL MOT. Diesel Motor	KRANK ARKA Crank Shaft Rear	2418F475		12010753	15026903	133,35	158,94	159,16	11,11	13,00	L13TL SOL -Left	FKM
415137-V	DİZEL MOT. Diesel Motor	KRANK ARKA Crank Shaft Rear	2418F475		12010753	15026903	133,35	159,05	-	11,11	13,00	L3L SOL -Left	FKM
415106-S	DİZEL MOT. Diesel Motor	KRANK ARKA Crank Shaft Rear	2415391		15026903	12010753	133,35	159,05	-	12,70	-	L3 SOL -Left	VMQ
45-084-V	1103-1104-1106-A4-A6-AT6-T-1006 MOT.	SUPAP Valve Stem Seal	2418M519	4225347M1	12035737		9,00	13,05	35,00	12,90	17,20	LSY5T	FKM
45-009-V	DİZEL MOT. Diesel Motor	SUPAP Valve Stem Seal	736840M1	33817117 33817125	12016623	292610	9,45	14,25	16,61	10,69	14,27	L	FKM

## MOTOR GRUBU / Engine Group

SKT NO	KULLANILAN MODELLER Models	KULLANIM YERİ Place Of Use	ORJINAL NO 1 Orijinal No 1	ORJINAL NO 2 Orijinal No 2	EŞDEĞER NO 1 Equivalent No 1	EŞDEĞER NO 2 Equivalent No 2	ÖLÇÜLER MM. Dimensions-MM.					TİP Type	MALZEME Material
047558-V	TRAKTÖR SERİSİ-PERKINS ENG. Tractor Series - Perkins Engine	KRANK ÖN Crank Shaft Front	7701031630		12014981		60,33	79,62	-	9,52	11,11	L3L SAĞ -Right	FKM
047894-V	TRAKTÖR SERİSİ-PERKINS ENG. Tractor Series - Perkins Engine	KRANK ÖN Crank Shaft Front	5430020364	7701031630	12014981	578.010	60,33	79,63	-	9,33	11,23	L3TL SAĞ -Right	FKM
415171-V	TRAKTÖR SERİSİ-PERKINS ENG. Tractor Series - Perkins Engine	KRANK ARKA Crank Shaft Rear	2418F475	1447691M1	12010753	15026903	133,35	158,94	159,16	11,11	13,00	L13TL SOL -Left	FKM
415137-V	TRAKTÖR SERİSİ-PERKINS ENG. Tractor Series - Perkins Engine	KRANK ARKA Crank Shaft Rear	2418F475	1447691M1	12010753	15026903	133,35	159,05	-	11,11	-	L3L SOL -Left	FKM
45-009-V	DİZEL MOT. Diesel Motor	SUPAP Valve Stem Seal	736840M1	33817117 33817125	12016623	292610	9,45	14,25	16,61	10,69	14,27	L	FKM

## AKS ve DİFERANSİYEL GRUBU / Axle and Differential Group

SKT NO	KULLANILAN MODELLER Models	KULLANIM YERİ Place Of Use	ORJINAL NO 1 Orijinal No 1	ORJINAL NO 2 Orijinal No 2	EŞDEĞER NO 1 Equivalent No 1	EŞDEĞER NO 2 Equivalent No 2	ÖLÇÜLER MM. Dimensions-MM.					TİP Type	MALZEME Material
046201-NL	TRAKTÖR SERİSİ Tractor Series	ÖN AKS Front Axle	6000104562		12014977	993.460	45,00	60,00	-	16,00	-	KOMBI 1X	NBR+TPU
046203-VL	TRAKTÖR SERİSİ Tractor Series	ÖN AKS Front Axle	6000104488		12017310		48,00	65,00	-	16,50	-	KOMBI 1X	FKM+TPU
046199-NK	TRAKTÖR SERİSİ Tractor Series	ÖN AKS DİFERANSİYEL Front Axle-Differential	6000101409		12001882		35,00	52,00	-	16,00	-	KOMBI 3	NBR-YÜN
046300-NK	TRAKTÖR SERİSİ Tractor Series	ÖN AKS DİFERANSİYEL Front Axle-Differential	6000103016		12011969		45,00	65,00	-	12,00	-	KOMBI 3	NBR+YÜN
046202-NL	TRAKTÖR SERİSİ Tractor Series	ÖN AKS DİFERANSİYEL Front Axle-Differential	6005009867		12012377		45,00	65,00	-	18,50	-	KOMBI 1X	NBR+TPU
047920-NL	TRAKTÖR SERİSİ Tractor Series	ÖN AKS DİFERANSİYEL Front Axle-Differential	6000105275		12001902		58,00	82,00	-	15,00	-	KOMBI 1X	NBR+TPU
047920-VL	TRAKTÖR SERİSİ Tractor Series	ÖN AKS DİFERANSİYEL Front Axle-Differential	6000105275		12017237		58,00	82,00	-	16,00	-	KOMBI 1X	FKM+TPU

## MOTOR GRUBU / Engine Group

SKT NO	KULLANILAN MODELLER Models	KULLANIM YERİ Place Of Use	ORJINAL NO 1 Orijinal No 1	ORJINAL NO 2 Orijinal No 2	EŞDEĞER NO 1 Equivalent No 1	EŞDEĞER NO 2 Equivalent No 2	ÖLÇÜLER MM. Dimensions-MM.					TİP Type	MALZEME Material
047495-P	TRAKTÖR SERİSİ Tractor Series	KRANK ÖN Crank Shaft Front	215190100		12010700		58,00	80,00	-	10,00	-	L3L SAÇ -Right	ACM
410253-S	TRAKTÖR SERİSİ Tractor Series	KRANK ARKA Crank Shaft Rear	21519009010	2.1519.009.0	12014410		98,00	120,00	-	13,00	-	L3L SOL -Left	VMQ
412189-S	TRAKTÖR SERİSİ Tractor Series	KRANK ARKA Crank Shaft Rear	215290730	784894R91 6005605198	12012521		110,00	130,00	-	13,00	-	L1L SOL -Left	VMQ
412189-V	TRAKTÖR SERİSİ Tractor Series	KRANK ARKA Crank Shaft Rear	215290730		12012521		110,00	130,00	-	13,00	-	L1L SOL -Left	FKM
412276-V	TRAKTÖR SERİSİ Tractor Series	KRANK ARKA Crank Shaft Rear	04253542		12014877		120,00	140,00	-	13,00	10,50	LL13 SOL -Left	FKM
041174	TRAKTÖR SERİSİ Tractor Series	YAKIT POMPASI Fuel Pump	215100100	215200100	12011122	12010846	25,00	35,00	-	7,00	-	L3	NBR
040594	TRAKTÖR SERİSİ Tractor Series	SU POMPASI Water Pump	215103110		12010867		26,00	47,00	-	7,00	-	L3	NBR
045361	TRAKTÖR SERİSİ Tractor Series	SU POMPASI Water Pump	215102170		12010908		35,00	52,00	-	10,00	-	L3L	NBR

## AKS ve DİFERANSİYEL GRUBU / Axle and Differential Group

SKT NO	KULLANILAN MODELLER Models	KULLANIM YERİ Place Of Use	ORJINAL NO 1 Orijinal No 1	ORJINAL NO 2 Orijinal No 2	EŞDEĞER NO 1 Equivalent No 1	EŞDEĞER NO 2 Equivalent No 2	ÖLÇÜLER MM. Dimensions-MM.					TİP Type	MALZEME Material
045665	TRAKTÖR SERİSİ Tractor Series	ÖN AKS DİFERANSİYEL Front Axle-Differential	215200170	504434	12011146		35,00	55,00	-	11,00	-	L3L	NBR
046296-NKL	TRAKTÖR SERİSİ Tractor Series	ÖN AKS DİFERANSİYEL Front Axle-Differential	215290780	215290850	12012566		45,00	62,00	-	16,00	-	KOMBI 4	NBR-TPU- YÜN
046202-NL	TRAKTÖR SERİSİ Tractor Series	ÖN AKS DİFERANSİYEL Front Axle-Differential	215291120		12012377		45,00	65,00	-	18,50	-	KOMBI 1X	NBR+TPU
046223-NL	4x4 TRAKTÖR SERİSİ 4x4 Tractor Series	ÖN AKS DİFERANSİYEL Front Axle-Differential	215291110		12014048		50,00	72,00	-	16,50	-	KOMBI 1X	NBR+TPU
047930-PN	TRAKTÖR SERİSİ Tractor Series	ÖN AKS DİFERANSİYEL Front Axle-Differential	090000839	215291130	12016445		56,00	80,00	-	13,00	14,50	SC6	ACM+NBR
450078-PK	TRAKTÖR SERİSİ Tractor Series	ÖN AKS Front Axle	21529069020		19033620		240,00	270,00	-	25,00	-	KOMBI 3	ACM+YÜN
045267	TRAKTÖR SERİSİ Tractor Series	ARKA AKS Rear Axle	215103260	90300740436	1032639		50,00	70,00	-	10,00	-	L3	NBR
047059	TRAKTÖR SERİSİ Tractor Series	ARKA AKS Rear Axle	215100410		12002284	01002942	80,00	100,00	-	10,00	-	L3	NBR



**AKS ve DİFERANSİYEL GRUBU / Axle and Differential Group**

SKT NO	KULLANILAN MODELLER Models	KULLANIM YERİ Place Of Use	ORJINAL NO 1 Orijinal No 1	ORJINAL NO 1 Orijinal No 2	EŞDEĞER NO 1 Equivalent No 1	EŞDEĞER NO 1 Equivalent No 2	ÖLÇÜLER MM. Dimensions-MM.					TİP Type	MALZEME Material
045623-P	TRAKTÖR SERİSİ Tractor Series	ARKA AKS PORYA İÇ Rear Axle Inner	215290320	90374533	12011466		55,00	72,00	-	12,00	-	LL3T	ACM
047496	TRAKTÖR SERİSİ Tractor Series	ARKA AKS PORYA İÇ Rear Axle Inner	21529007010		12017076		58,00	80,00	-	13,00	-	L1L	NBR
410252	TRAKTÖR SERİSİ Tractor Series	ARKA AKS İÇ Rear Axle Inner	215200430	215295010	12011206	12011036	85,00	110,00	-	12,00	-	L3L	NBR
040290	TRAKTÖR SERİSİ Tractor Series	FREN SİSTEMİ Brake System	215100190		12010923		38,00	50,00	-	7,00	-	L3	NBR
045226	TRAKTÖR SERİSİ Tractor Series	DİF.ÖN-MAHRUTİ Differential Front	04344813 215202200	000051300	12011158		40,00	60,00	-	10,00	-	L3L	NBR
047101-V	TRAKTÖR SERİSİ Tractor Series	DİFR.GÜÇ AKT. MİLİ Diff.Transfer Shaft	215106290		12011188	12010988	55,00	90,00	-	10,00	-	L3	FKM
045700	TRAKTÖR SERİSİ Tractor Series	DİFERANSİYEL SİSTEMİ Differential System	215203200		12011160		40,00	62,00	-	10,00	-	L3L	NBR
045779	TRAKTÖR SERİSİ Tractor Series	DİFERANSİYEL SİSTEMİ Differential System	215102230		12011168		45,00	65,00	-	10,00	-	L3L	NBR
045934	TRAKTÖR SERİSİ Tractor Series	DİFERANSİYEL SİSTEMİ Differential System	215202260		12011177		50,00	72,00	-	7,00	-	L3BTL	NBR
045229	TRAKTÖR SERİSİ Tractor Series	DİFERANSİYEL SİSTEMİ Differential System	215100460	215104260	12010971		50,00	72,00	-	10,00	-	L3	NBR
047718	TRAKTÖR SERİSİ Tractor Series	DİFERANSİYEL SİSTEMİ Differential System	215202310		12011192		60,00	80,00	-	10,00	-	L3TL	NBR
047700	TRAKTÖR SERİSİ Tractor Series	DİFERANSİYEL SİSTEMİ Differential System	215203360		12011200	12011016	70,00	100,00	-	10,00	-	L3TL	NBR
047756	TRAKTÖR SERİSİ Tractor Series	DİFERANSİYEL SİSTEMİ Differential System	215200390		12011201		75,00	95,00	-	10,00	-	L13TL SS-RL	NBR

**ŞANZİMAN GRUBU / Gearbox Group**

SKT NO	KULLANILAN MODELLER Models	KULLANIM YERİ Place Of Use	ORJINAL NO 1 Orijinal No 1	ORJINAL NO 1 Orijinal No 2	EŞDEĞER NO 1 Equivalent No 1	EŞDEĞER NO 1 Equivalent No 2	ÖLÇÜLER MM. Dimensions-MM.					TİP Type	MALZEME Material
045198	TRAKTÖR SERİSİ Tractor Series	ŞANZİMAN ÖN Gearbox Front	215101230	0-7254219 3382237M1	12010954		45,00	62,00	-	10,00	-	L3	NBR
045744	TRAKTÖR SERİSİ Tractor Series	ŞANZİMAN ÖN Gearbox Front	215290270	7254219	01034644		45,00	62,00	-	10,00	-	L1L	NBR
045609-P	TRAKTÖR SERİSİ Tractor Series	ŞANZİMAN ÖN Gearbox Front	215290290		12014056	19026746	45,00	62,00	-	10,00	-	L3 SAĞ -Right	ACM

## ŞANZIMAN GRUBU / Gearbox Group

SKT NO	KULLANILAN MODELLER Models	KULLANIM YERİ Place Of Use	ORJINAL NO 1 Original No 1	ORJINAL NO 2 Original No 2	EŞDEĞER NO 1 Equivalent No 1	EŞDEĞER NO 2 Equivalent No 2	ÖLÇÜLER MM. Dimensions-MM.					TİP Type	MALZEME Material
045744-V	TRAKTÖR SERİSİ Tractor Series	ŞANZIMAN ÖN Gearbox Front	215290290		12014056		45,00	62,00	-	10,00	-	L1L	FKM
045776-V	TRAKTÖR SERİSİ Tractor Series	ŞANZIMAN ÖN Gearbox Front	215290790		12013865		50,00	68,00	-	10,00	-	L3TL SAĞ -Right	FKM
047591-P	TRAKTÖR SERİSİ Tractor Series	ŞANZIMAN ARKA Gearbox Rear	215290220		12001479		55,00	80,00	-	10,00	-	L1L	ACM
040591	TRAKTÖR SERİSİ Tractor Series	ŞANZIMAN MİLİ Gearbox Shaft	215200020		12011111		16,00	28,00	-	7,00	-	L3L	NBR
041160	TRAKTÖR SERİSİ Tractor Series	ŞANZIMAN MİLİ Gearbox Shaft	215200060	215691510	12011114		20,00	30,00	-	7,00	-	L3	NBR
040713	TRAKTÖR SERİSİ Tractor Series	ŞANZIMAN MİLİ Gearbox Shaft	01172559		01026703		22,00	35,00	-	7,00	-	L3L	NBR
040745	TRAKTÖR SERİSİ Tractor Series	ŞANZIMAN MİLİ Gearbox Shaft	215100100	215200100	12011122		25,00	35,00	-	7,00	-	L3TL	NBR
040765	TRAKTÖR SERİSİ Tractor Series	ŞANZIMAN MİLİ Gearbox Shaft	215295180	025498	12011131		30,00	40,00	-	7,00	-	L3L	NBR
045254	TRAKTÖR SERİSİ Tractor Series	ŞANZIMAN MİLİ Gearbox Shaft	215106170		12010914		35,00	62,00	-	10,00	-	L3	NBR
045269	TRAKTÖR SERİSİ Tractor Series	ŞANZIMAN MİLİ Gearbox Shaft	215106200		12010938	12000504	40,00	65,00	-	10,00	-	L3	NBR
047229	TRAKTÖR SERİSİ Tractor Series	ŞANZIMAN MİLİ Gearbox Shaft	215100360		12014022		70,00	85,00	-	8,00	-	L3	NBR
047343	TRAKTÖR SERİSİ Tractor Series	ŞANZIMAN MİLİ Gearbox Shaft	215290040		12011533	01002684	70,00	90,00	-	10,00	-	L1	NBR
047343-V	TRAKTÖR SERİSİ Tractor Series	ŞANZIMAN MİLİ Gearbox Shaft	215290040		12011533	01002684	70,00	90,00	-	10,00	-	L1	FKM
045224	TRAKTÖR SERİSİ Tractor Series	PTO KUYRUK MİLİ Power Take Off Shaft	215103170		12010910		35,00	56,00	-	10,00	-	L3	NBR
047815-P	TRAKTÖR SERİSİ Tractor Series	PTO KUYRUK MİLİ Power Take Off Shaft	215202310		12011192		60,00	80,00	-	10,00	-	L3L	ACM
047201	TRAKTÖR SERİSİ Tractor Series	PTO KUYRUK MİLİ Power Take Off Shaft	215290260	AL150750 AL202939	12015980		70,00	100,00	-	13,00	-	SL	NBR
040447	TRAKTÖR SERİSİ Tractor Series	DEBRİYAJ MİLİ Clutch Shaft	215107060		12010832		20,00	47,00	-	10,00	-	L3L	NBR
040493	TRAKTÖR SERİSİ Tractor Series	DEBRİYAJ MİLİ Clutch Shaft	215190230		-	-	26,00	37,00	-	7,00	-	L1 SOL -Left	NBR

**DİĞER GRUPLAR / Others Group**

SKT NO	KULLANILAN MODELLER Models	KULLANIM YERİ Place Of Use	ORJINAL NO 1 Orijinal No 1	ORJINAL NO 2 Orijinal No 2	EŞDEĞER NO 1 Equivalent No 1	EŞDEĞER NO 2 Equivalent No 2	ÖLÇÜLER MM. Dimensions-MM.					TİP Type	MALZEME Material
040284	TRAKTÖR SERİSİ Tractor Series	HİDROLİK POMPA Hydraulic Pump	215102030		12010808		17,00	30,00	-	7,00	-	L3	NBR
045543	TRAKTÖR SERİSİ Tractor Series	HİD. KALDIRMA SİSTEMİ Hydraulic Lifting System	215100290		12010981		55,00	70,00	-	8,00	-	L3	NBR
045944	TRAKTÖR SERİSİ Tractor Series	MİL KEÇESİ Shaft Seal	215290920		12011126	01002458	25,00	52,00	-	7,00	-	L3TL	NBR
045239	TRAKTÖR SERİSİ Tractor Series	MİL KEÇESİ Shaft Seal	215106130		12010889		30,00	55,00	-	10,00	-	L3	NBR
040872	TRAKTÖR SERİSİ Tractor Series	MİL KEÇESİ Shaft Seal	215191070		12010895		32,00	47,00	-	7,00	-	L3TL	NBR
045493	TRAKTÖR SERİSİ Tractor Series	MİL KEÇESİ Shaft Seal	215105170		12010912		35,00	60,00	-	10,00	-	L3	NBR
045831	TRAKTÖR SERİSİ Tractor Series	MİL KEÇESİ Shaft Seal	215202170		12011148		35,00	62,00	-	10,00	-	L3L	NBR
045497	TRAKTÖR SERİSİ Tractor Series	MİL KEÇESİ Shaft Seal	215101190		12010925		38,00	52,00	-	7,00	-	L3	NBR
045355	TRAKTÖR SERİSİ Tractor Series	MİL KEÇESİ Shaft Seal	215201310		12011191		60,00	75,00	-	8,00	-	L3	NBR
047456	TRAKTÖR SERİSİ Tractor Series	MİL KEÇESİ Shaft Seal	215202310		12011192	12010999 12015900	60,00	80,00	-	10,00	12,00	L3L	NBR
047232	TRAKTÖR SERİSİ Tractor Series	MİL KEÇESİ Shaft Seal	215100330		12011006		64,00	80,00	-	8,00	-	L3	NBR
047450	TRAKTÖR SERİSİ Tractor Series	MİL KEÇESİ Shaft Seal	215100340		12011007	12011008	65,00	85,00	-	10,00	-	L3	NBR
047697	TRAKTÖR SERİSİ Tractor Series	MİL KEÇESİ Shaft Seal	215104340		12011011		65,00	100,00	-	10,00	-	L3TL	NBR
410113	TRAKTÖR SERİSİ Tractor Series	MİL KEÇESİ Shaft Seal	215104470		12011047		95,00	120,00	-	12,00	-	L3	NBR
410121	TRAKTÖR SERİSİ Tractor Series	MİL KEÇESİ Shaft Seal	215200490		12011209		100,00	120,00	-	12,00	-	L3	NBR
412318	TRAKTÖR SERİSİ Tractor Series	MİL KEÇESİ Shaft Seal	21529056010		12015500		110,00	140,00	-	15,00	-	L3TL SS-RL	NBR
415084	TRAKTÖR SERİSİ Tractor Series	MİL KEÇESİ Shaft Seal	215290380		12011373		145,00	170,00	-	13,00	-	L1L	NBR

# STEYR - BAŞAK

## MOTOR GRUBU / Engine Group

SKT NO	KULLANILAN MODELLER Models	KULLANIM YERİ Place Of Use	ORJINAL NO 1 Orijinal No 1	ORJINAL NO 1 Orijinal No 2	EŞDEĞER NO 1 Equivalent No 1	EŞDEĞER NO 1 Equivalent No 2	ÖLÇÜLER MM. Dimensions-MM.					TİP Type	MALZEME Material
045850-V	768-8050-8073	KRANK ÖN Crank Shaft Front	98488391 99469265	99469265 40000010	12014859		42,00	65,00	-	10,00	-	L13T SAÇ -Right	FKM
045537-S	768-8050-8073	KRANK ÖN Crank Shaft Front	40000010	7151917	12011460	12013479	42,00	65,00	-	12,00	-	L1L SAÇ -Right	VMQ
045537-V	768-8050-8073	KRANK ÖN Crank Shaft Front	40000010		12011460	12013479	42,00	65,00	-	12,00	-	L1L SAÇ -Right	FKM
410276-S	768-8050-8073	KRANK ARKA Crank Shaft Rear	90003074467	25A355	12012347		85,00	105,00	-	12,00	-	L3TL SOL -Left	VMQ
410276-V	768-8050-8073	KRANK ARKA Crank Shaft Rear	90003174467	90003074467 25A360	12012347		85,00	105,00	-	12,00	-	L3TL SOL -Left	FKM
412235-V	TRAKTÖR SERİSİ Tractor Series	KRANK ARKA Crank Shaft Rear	504127327		12014858	12016274	114,00	135,00	-	13,00	-	L1L SOL -Left	FKM
412281-V	TRAKTÖR SERİSİ Tractor Series	KRANK ARKA Crank Shaft Rear	504127327		12016274	12014858	114,00	135,00	-	13,00	-	L13TL SOL -Left	FKM
045649-S	768-8050-8073	EKSANTRİK MİLİ Cam Shaft	407.01.0065	90300740332			50,00	65,00	-	10,00	-	L3TL SAÇ -Right	VMQ
045649-V	768-8050-8073	EKSANTRİK MİLİ Cam Shaft	90003174432	90030740432			50,00	65,00	-	10,00	-	L3TL SAÇ -Right	FKM
45-007	768-8050-8073	SUPAP Valve Stem Seal	31100500016	315050016			7,90	15,90	19,30	7,00	12,00	LA1	NBR
040594	8050-8073	SU POMPASI Water Pump	90003070075				26,00	47,00	-	7,00	-	L3	NBR
436	768-8050-8073	SU POMPASI Water Pump	4060646 40706008	90003070075			27,00	47,00	-	22,00	-	KO10	NBR
045573	768-8073	SU POMPASI Water Pump					44,45	73,20	-	12,70	-	L3	NBR
047458	768-8073	SU POMPASI Water Pump	C5NNP788A				47,62	76,37	-	12,70	-	L3	NBR
047326	768-8073	SU POMPASI Water Pump					57,15	85,90	-	12,70	-	L3	NBR
040507	TRAKTÖR SERİSİ Tractor Series	ŞARJ DİNAMOSU Charge System	5300270118				32,00	42,00	-	7,00	10,00	L1C	NBR

## AKS ve DİFERANSİYEL GRUBU / Axle and Differential Group

SKT NO	KULLANILAN MODELLER Models	KULLANIM YERİ Place Of Use	ORJINAL NO 1 Orijinal No 1	ORJINAL NO 1 Orijinal No 2	EŞDEĞER NO 1 Equivalent No 1	EŞDEĞER NO 1 Equivalent No 2	ÖLÇÜLER MM. Dimensions-MM.					TİP Type	MALZEME Material
046281	TRAKTÖR SERİSİ Tractor Series	ÖN AKS Front Axle	HFA200116		-		47,00	75,00	-	14,00	17,00	SC7	NBR
047590	8050	ARKA AKS Rear Axle	90003170054				85,00	100,00	-	9,00	10,50	L3TLL	NBR
47590-P	8050	ARKA AKS Rear Axle	90003070054				85,00	100,00	-	9,00	10,50	L3TLL	ACM
410258	768-8073	ARKA AKS Rear Axle	90003074378				100,00	120,00	-	14	16,00	L3TLL	NBR
045768-P	8033-8043-8050	ARKA AKS DIŞ Rear Axle Outer	90003174435	90300740435			50,00	68,00	-	8,00	-	L3TL	ACM
045697-P	8073	ARKA AKS DIŞ Rear Axle Outer	90003074436	90374436	-	-	50,00	70,00	-	8,00	-	L3T	ACM
047503-P	768	ARKA AKS DIŞ Rear Axle Outer	90003074349	90374349 25A3710			60,00	80,00	-	13,00	-	L3TL	ACM
045753-P	768-8050-8033-8073	ARKA AKS İÇ Rear Axle Inner	90003170055 90037055	90003070055			42,00	62,00	-	8,00	-	LL3T	ACM
045623-P	768-8073	ARKA AKS PORYA İÇ Rear Axle Inner	90003074342				55,00	72,00	-	12,00	-	LL3T	ACM
045623-V	768-8073	ARKA AKS PORYA İÇ Rear Axle Inner	90003074342	9030740342			55,00	72,00	-	12,00	-	LL3T	FKM
045909	4x4 TRAKTÖR SERİSİ 4x4 Tractor Series	AKS SİSTEMİ Axle System	35X72X10		12010915	12013421	35,00	72,00	-	10,00	-	L3T	NBR

## ŞANZİMAN GRUBU / Gearbox Group

SKT NO	KULLANILAN MODELLER Models	KULLANIM YERİ Place Of Use	ORJINAL NO 1 Orijinal No 1	ORJINAL NO 1 Orijinal No 2	EŞDEĞER NO 1 Equivalent No 1	EŞDEĞER NO 1 Equivalent No 2	ÖLÇÜLER MM. Dimensions-MM.					TİP Type	MALZEME Material
040644-P	8050	ŞANZİMAN ÖN Gearbox Front	90003070014	90003070030	12010867		28,00	40,00	-	7,00	-	L3TL SS -RL	ACM
040590	8073	ŞANZİMAN ÖN Gearbox Front	9000307001	90300300701			35,00	45,00	-	7,00	-	L1 SAĞ -Right	NBR
045622	768	ŞANZİMAN ÖN-ALT Gearbox Front-Lower	90003072744	25A3645			40,00	58,00	-	12,00	-	L3X	NBR
045779-V	TRAKTÖR SERİSİ Tractor Series	ŞANZİMAN ÖN Gearbox Front	90003074430				45,00	65,00	-	10,00	-	L3L	FKM

# STEYR - BAŞAK

## ŞANZİMAN GRUBU / Gearbox Group

SKT NO	KULLANILAN MODELLER Models	KULLANIM YERİ Place Of Use	ORJİNAL NO 1 Orijinal No 1	ORJİNAL NO 2 Orijinal No 2	EŞDEĞER NO 1 Equivalent No 1	EŞDEĞER NO 2 Equivalent No 2	ÖLÇÜLER MM. Dimensions-MM.					TİP Type	MALZEME Material
045820-V	8073	ŞANZİMAN ÖN Gearbox Front	90003070017 9030740436	90374436 90003070017			50,00	70,00	-	8,00	-	L3TL SS-RL	FKM
047592-P	8050	ŞANZİMAN ÖN Gearbox Front	90003174338 90300740338	90003074338			50,00	80,00	-	8,00	-	L3TL SAĞ -Right	ACM
047314	TRAKTÖR SERİSİ Tractor Series	ŞANZİMAN ÖN Gearbox Front	90300780623				60,00	95,00	-	13,00	-	L3	NBR
045406	768	ŞANZİMAN ARKA Gearbox Rear	90003070035	90374660 25A3675	12011174		50,00	65,00	-	8,00	-	L3	NBR
040289	TZDK 8043	ŞANZ. HAREKET ANA MİL Gearbox - Overgear	90300300701		12010903		35,00	45,00	-	7,00	-	L3	NBR
040509-P	TZDK 768 68 HP	ŞANZ. HAREKET ANA MİL Gearbox - Overgear	90003074316				35,00	47,00	-	10,00	11,00	L3TL	ACM
040509-P	768	HARAKET DİŞLİ MİLİ Gearbox Overgear Shaft	90003074316	90374316			35,00	47,00	-	10,00	11,00	L3TL	ACM
045621	768	ŞANZİMAN MİLİ Gearbox Shaft	90003072745	292021040			35,00	58,00	-	14,00	-	L3X	NBR
045831-V	TRAKTÖR SERİSİ Tractor Series	ŞANZİMAN MİLİ Gearbox Shaft	33700290260				35,00	62,00	-	10,00	-	L3L	FKM
045856	8043-50	ŞANZİMAN MİLİ Gearbox Shaft	80072004				42,00	52,00	-	7,00	-	L3L	NBR
040188	TRAKTÖR SERİSİ Tractor Series	ŞANZ. KLM ÇIKIŞ MİLİ Speedometer Shaft	90003074250				18,00	30,00	-	7,00	-	L3	NBR
040286-V	TRAKTÖR SERİSİ Tractor Series	PTO KUYRUK MİLİ Power Take Off Shaft	87528273		12001163		25,00	40,00	-	7,00	-	L3	FKM
045678-P	768-8050-8073	PTO KUYRUK MİLİ Power Take Off Shaft	90003074426	903074426			40,00	62,00	-	8,00	-	L3TL	ACM
045821-P	768-8050-8073	PTO KUYRUK MİLİ Power Take Off Shaft	90003070035 90374660	5124606 392825X1			50,00	65,00	-	8,00	-	L3L	ACM
047915-P	TRAKTÖR SERİSİ Tractor Series	PTO KUYRUK MİLİ Power Take Off Shaft	53002100420				60,00	95,00		10,00		L3L SAĞ -Right	ACM
047561-P	TRAKTÖR SERİSİ Tractor Series	PTO KUYRUK MİLİ Power Take Off Shaft	90003078623	90378623			60,00	95,00	-	10,00	-	L3 SAĞ -Right	ACM
410510	TRAKTÖR SERİSİ Tractor Series	PTO KUYRUK MİLİ Power Take Off Shaft	5300320050				100,00	120,00		14,10		L3TLL	NBR
040594-P	8050-8073	VİTES SEÇİCİ MİL Gear Selection Shaft	90003070075		12010867		26,00	47,00	-	7,00	-	L3	ACM

## HİDROLİK GRUBU / Hydraulic Group

SKT NO	KULLANILAN MODELLER Models	KULLANIM YERİ Place Of Use	ORJINAL NO 1 Original No 1	ORJINAL NO 1 Original No 2	EŞDEĞER NO 1 Equivalent No 1	EŞDEĞER NO 1 Equivalent No 2	ÖLÇÜLER MM. Dimensions-MM.					TİP Type	MALZEME Material
4U-299	TRAKTÖR SERİSİ Tractor Series	HİDROLİK SİSTEMİ Hydraulic System	337007300620				55,00	75,00	-	10,00	6,50	UCL	NBR
040558	768-8050-8073	HİDROLİK POMPA Hydraulic Pump	90003174300	90003074300	90374300		20,00	40,00	-	7,00	8,00	L3BL	NBR
4TM-037	8033-8043-8073 SERİSİ	HİDROLİK POMPA-HEMA TİP Hydraulic Pump-Hema Type	IPI.100.247	5005070/0320			-		-	-	-	TM	-
045543	768	HİD. KALDIRMA SİSTEMİ Hydraulic Lifting System	90003078562		12010981		55,00	70,00	-	8,00	-	L3	NBR
045822	768-8050-8073	HİD. KALDIRMA SİSTEMİ Hydraulic Lifting System	47970741	35700730166	12011182		55,00	70,00	-	8,00	-	L3L	NBR
4U-250-80	8050-8073	HİD. KALDIRMA SİSTEMİ Hydraulic Lifting System	28873102	28800730102			60,00	85,00	-	12,00	6,00	U3L	NBR
4TM-046	768-8073	HİD. KALDIRMA SİSTEMİ Hydraulic Lifting System	2703238	50050700321			-	-	-	-	-	TM	-
4TM-047	768-8073	HİD. KALDIRMA SİSTEMİ Hydraulic Lifting System	058732302 058730023	50050700322 25A1255			-	-	-	-	-	TM	-

## MOTOR GRUBU / Engine Group

SKT NO	KULLANILAN MODELLER Models	KULLANIM YERİ Place Of Use	ORJINAL NO 1 Original No 1	ORJINAL NO 1 Original No 2	EŞDEĞER NO 1 Equivalent No 1	EŞDEĞER NO 1 Equivalent No 2	ÖLÇÜLER MM. Dimensions-MM.					TİP Type	MALZEME Material
045850-V	60/74-82/80	KRANK ÖN Crank Shaft Front	0-7151916	7151916 40100874	12014859		42,00	65,00	-	10,00	-	L13TL SAĞ -Right	FKM
045537-S	60-74-82/80 SERİSİ	KRANK ÖN Crank Shaft Front	40000015	40101333	12011460	12013479	42,00	65,00	-	12,00	-	L1L SAĞ -Right	VMQ
045537-V	60-74-82/80 SERİSİ	KRANK ÖN Crank Shaft Front	40000015	7151917	12011460	12013479	42,00	65,00	-	12,00	-	L1L SAĞ -Right	FKM
046224-FP	TRAKTÖR SERİSİ Tractor Series	KRANK ÖN Crank Shaft Front	0-T7- 0000030977				45,00	67,00	-	8,00	-	F2TL SAĞ -Right	PTFE+ACM
412235-V	TRAKTÖR SERİSİ Tractor Series	KRANK ARKA Crank Shaft Rear	0-7151911	40003801	12014858	12016274	114,00	135,00	-	13,00	-	L1L SOL -Left	FKM
45-030-V	TRAKTÖR SERİSİ Tractor Series	SUPAP Valve Stem Seal	0-7153085				8,00	12,00	15,25	7,00	9,50	LSV2T	FKM

## AKS ve DİFERANSİYEL GRUBU / Axle and Differential Group

SKT NO	KULLANILAN MODELLER Models	KULLANIM YERİ Place Of Use	ORJINAL NO 1 Original No 1	ORJINAL NO 1 Original No 2	EŞDEĞER NO 1 Equivalent No 1	EŞDEĞER NO 1 Equivalent No 2	ÖLÇÜLER MM. Dimensions-MM.					TİP Type	MALZEME Material
046149	DT SERİSİ	ÖN AKS Front Axle	0-7257153				42,00	62,00	-	10,00	-	L1	NBR
046201-NL	TRAKTÖR SERİSİ Tractor Series	ÖN AKS Front Axle	0-7252922		12014977	993.460	45,00	60,00	-	16,00	-	KOMBI 1X	NBR+TPU
046281	TRAKTÖR SERİSİ Tractor Series	ÖN AKS Front Axle	HFA200116		-		47,00	75,00	-	14,00	17,00	SC7	NBR
047585-K	TRAKTÖR SERİSİ Tractor Series	ÖN AKS Front Axle	0-7253068				50,00	80,00	-	11,00	-	CSPSK	YÜN
047769-K	60-74-82/80-80/66 SERİSİ	ÖN AKS Front Axle	4951077				50,00	82,00	-	12,00	-	SK2	YÜN
417122-V	TRAKTÖR SERİSİ Tractor Series	ÖN AKS Front Axle	7154619	0-7254619			165,00	190,00	-	15,00	-	L3L	FKM
417117	TRAKTÖR SERİSİ Tractor Series	ÖN AKS Front Axle	0-7259635		12015135		165,00	190,00	-	15,50	17,00	SC6	NBR
417120	TRAKTÖR SERİSİ Tractor Series	ÖN AKS Front Axle	0AP- 0000000941	5184116 5177708	12019930		165,00	190,00	-	15,50	-	SC6-SS-RL	NBR
417127	TRAKTÖR SERİSİ Tractor Series	ÖN AKS Front Axle	0-7261548		12015150		165,00	195,00	-	16,50	18,00	SC6	NBR



## AKS ve DİFERANSİYEL GRUBU / Axle and Differential Group

SKT NO	KULLANILAN MODELLER Models	KULLANIM YERİ Place Of Use	ORJINAL NO 1 Orijinal No 1	ORJINAL NO 1 Orijinal No 2	EŞDEĞER NO 1 Equivalent No 1	EŞDEĞER NO 1 Equivalent No 2	ÖLÇÜLER MM. Dimensions-MM.					TİP Type	MALZEME Material
412278-NK	60-74-82/80 SERİSİ	ARKA AKS Rear Axle	5123205		12001912		100,00	130,00	-	16,00	-	KOMBI 3	NBR+YÜN
4TM-165	TRAKTÖR SERİSİ Tractor Series	ARKA AKS KOVAN Rear Axle	0-9150098	0-9150102									
410332	TRAKTÖR SERİSİ Tractor Series	ARKA AKS PORYA İÇ Rear Axle Inner	0-7259726	28537222	12011029		80,00	110,00	-	12,00	-	L3L	NBR
047253	4x4 TRAKTÖR SERİSİ 4x4 Tractor Series	DİF.ÖN-MAHRUTİ Differential Front	0-7262861		12011002		60,00	90,00	-	10,00	-	L3	NBR
047654-P	60-74-82/80 SERİSİ	DİF.ÖN-MAHRUTİ Differential Front	5136173	0-7254029			60,00	90,00	-	11,00	16,50	SPL1X	ACM
047654-V	60-74-82/80 SERİSİ	DİF.ÖN-MAHRUTİ Differential Front	7254029	5136173			60,00	90,00	-	11,00	16,50	SPL1X	FKM
047343-V	TRAKTÖR SERİSİ Tractor Series	DİF.ÖN-MAHRUTİ Differential Front	7250861		12011533		70,00	90,00	-	10,00	-	L1	FKM
410239-V	TRAKTÖR SERİSİ Tractor Series	DİF.ÖN-MAHRUTİ Differential Front	0-SP- 0000009107				80,00	105,00	-	13,00	-	L1L	FKM
047101-V	TRAKTÖR SERİSİ Tractor Series	DİFR.GÜÇ AKT. MİLİ Diff.Transfer Shaft	7253969		12011188	12010988	55,00	90,00	-	10,00	-	L3	FKM
412356-VN	TRAKTÖR SERİSİ Tractor Series	DİFERANSİYEL SİSTEMİ Differential System	0-T7- 0000014681				100,00	130,00		12,50	14,00	SC6	FKM+NBR

## ŞANZİMAN GRUBU / Gearbox Group

SKT NO	KULLANILAN MODELLER Models	KULLANIM YERİ Place Of Use	ORJINAL NO 1 Orijinal No 1	ORJINAL NO 1 Orijinal No 2	EŞDEĞER NO 1 Equivalent No 1	EŞDEĞER NO 1 Equivalent No 2	ÖLÇÜLER MM. Dimensions-MM.					TİP Type	MALZEME Material
040149-V	60-74-82/80 SERİSİ	ŞANZİMAN ÖN Gearbox Front	7251406 7261134	KH0156			25,00	35,00	-	7,00	-	L3	FKM
045287	TRAKTÖR SERİSİ Tractor Series	ŞANZİMAN ÖN Gearbox Front	0-SP- 0000018040	44882502 215101230			45,00	62,00	-	10,00	11,00	L3L	NBR
045744	60-74-82/80 SERİSİ	ŞANZİMAN ÖN Gearbox Front	40000270	0-7254219	01034644		45,00	62,00	-	10,00	-	L1L	NBR
045609-P	TRAKTÖR SERİSİ Tractor Series	ŞANZİMAN ÖN Gearbox Front	40000270 40000271	7254219	12014056	19026746	45,00	62,00	-	10,00	-	L3 SAĞ -Right	ACM
045744-V	60-74-82/80 SERİSİ	ŞANZİMAN ÖN Gearbox Front	7254219	0-7254219			45,00	62,00	-	10,00	-	L1L	FKM

## ŞANZİMAN GRUBU / Gearbox Group

SKT NO	KULLANILAN MODELLER Models	KULLANIM YERİ Place Of Use	ORJINAL NO 1 Orijinal No 1	ORJINAL NO 2 Orijinal No 2	EŞDEĞER NO 1 Equivalent No 1	EŞDEĞER NO 2 Equivalent No 2	ÖLÇÜLER MM. Dimensions-MM.					TİP Type	MALZEME Material
040838	TRAKTÖR SERİSİ Tractor Series	ŞANZ. İŞTİRAK DİŞLİSİ Gearbox - Overgear	7257643				18,00	30,00	-	6,40	-	L3BTL	NBR
045260	TRAKTÖR SERİSİ Tractor Series	ŞANZİMAN MİLİ Gearbox Shaft	0-7250860		12010977		52,00	72,00	-	10,00	-	L3	NBR
047526-V	TRAKTÖR SERİSİ Tractor Series	ŞANZİMAN MİLİ Gearbox Shaft	7254379				60,00	85,00	-	10,00	-	L1	FKM
047343	TRAKTÖR SERİSİ Tractor Series	ŞANZİMAN MİLİ Gearbox Shaft	7250861		12011533	01002684	70,00	90,00	-	10,00	-	L1	NBR
047343-V	TRAKTÖR SERİSİ Tractor Series	ŞANZİMAN MİLİ Gearbox Shaft	7250861		12011533	01002684	70,00	90,00	-	10,00	-	L1	FKM
040149	60-74-82/80 SERİSİ	PTO KUYRUK MİLİ Power Take Off Shaft	5105887	734300196	12011487		25,00	35,00	-	7,00	-	L3	NBR
041255-V	TRAKTÖR SERİSİ Tractor Series	PTO KUYRUK MİLİ Power Take Off Shaft	0-7261134	7261134			25,00	35,00		7,00		L3X	FKM
047479	60-74-82/80 SERİSİ	PTO KUYRUK MİLİ Power Take Off Shaft	7251603				55,00	85,00	-	10,00	-	L3	NBR
047047-V	TRAKTÖR SERİSİ Tractor Series	PTO KUYRUK MİLİ Power Take Off Shaft	7251626	0-7251626			68,00	90,00	-	10,00	-	L3	FKM
047757-V	TRAKTÖR SERİSİ Tractor Series	PTO KUYRUK MİLİ Power Take Off Shaft	5106229	5112290	01020466		68,00	90,00	-	10,00	-	L13TL SS-RL	FKM
040520-V	TRAKTÖR SERİSİ Tractor Series	DİŞLİ KUTUSU KAPAĞI Gearbox Cover	7251472	0-7251472			18,00	30,00	-	7,00	-	L1L	FKM

## DİĞER GRUPLAR / Others Group

SKT NO	KULLANILAN MODELLER Models	KULLANIM YERİ Place Of Use	ORJINAL NO 1 Original No 1	ORJINAL NO 2 Original No 2	EŞDEĞER NO 1 Equivalent No 1	EŞDEĞER NO 2 Equivalent No 2	ÖLÇÜLER MM. Dimensions-MM.					TİP Type	MALZEME Material
040273	TRAKTÖR SERİSİ Tractor Series	DİREKSİYON MİLİ Steering Shaft	0-SP- 0000018045				28,00	38,00	-	7,00	-	L3	NBR
4P-309-V	TRAKTÖR SERİSİ Tractor Series	HİDROLİK SİSTEMİ Hydraulic System	7254332				56,00	70,00	-	7,50	-	PI3L	FKM
4P-005	TRAKTÖR SERİSİ Tractor Series	HİDROLİK SİSTEMİ Hydraulic System	7257161				100,00	115,00	-	8,00	-	PI3L	NBR
040838-V	TRAKTÖR SERİSİ Tractor Series	HİDROLİK POMPA Hydraulic Pump	7257643		12011834		18,00	30,00	-	6,00	-	L3BTL	FKM
040817-P	TRAKTÖR SERİSİ Tractor Series	MİL KEÇESİ Shaft Seal	7258792	8291847	12001669		20,00	30,00	-	7,00	-	L13TL	ACM
045643-V	TRAKTÖR SERİSİ Tractor Series	MİL KEÇESİ Shaft Seal	7254389	0-7254389			40,00	62,00	-	10,00	-	L1	FKM
047713-V	TRAKTÖR SERİSİ Tractor Series	MİL KEÇESİ Shaft Seal	7257754	0-7257754			40,00	90,00	-	10,00	-	L3TL	FKM
046149-V	TRAKTÖR SERİSİ Tractor Series	MİL KEÇESİ Shaft Seal	7257153	0-7257153			42,00	62,00	-	10,00	-	L1	FKM
045355	TRAKTÖR SERİSİ Tractor Series	MİL KEÇESİ Shaft Seal	0-SP- 0000020264		12011191		60,00	75,00	-	8,00	-	L3	NBR
047468-V	TRAKTÖR SERİSİ Tractor Series	MİL KEÇESİ Shaft Seal	0-SP- 0000017694				60,00	85,00	-	10,00	-	L3L	FKM
410107	TRAKTÖR SERİSİ Tractor Series	MİL KEÇESİ Shaft Seal	0-7262862		12013388		85,00	110,00	-	13,00	-	L3	NBR

## AKS ve DİFERANSİYEL GRUBU / Axle and Differential Group

SKT NO	KULLANILAN MODELLER Models	KULLANIM YERİ Place Of Use	ORJINAL NO 1 Original No 1	ORJINAL NO 2 Original No 2	EŞDEĞER NO 1 Equivalent No 1	EŞDEĞER NO 2 Equivalent No 2	ÖLÇÜLER MM. Dimensions-MM.					TİP Type	MALZEME Material
417128	TRAKTÖR SERİSİ Tractor Series	ÖN AKS Front Axle	31795910	KH4967	12018035	12014283	150,00	180,00	-	14,50	16,00	SC6	NBR
046208-NK	TRAKTÖR SERİSİ Tractor Series	ÖN AKS İÇ Front Axle Inner	KH1213		12001889		42,00	62,00	-	14,00	-	KOMBI 3	NBR+YÜN
046298-NK	TRAKTÖR SERİSİ Tractor Series	ÖN AKS DİFERANSİYEL Front Axle-Differential	KH1216		12001886		40,00	55,00	-	10,00	-	KOMBI 3	NBR+YÜN
046202-NL	TRAKTÖR SERİSİ Tractor Series	ÖN AKS DİFERANSİYEL Front Axle-Differential	31790510		12012377		45,00	65,00	-	18,50	-	KOMBI 1X	NBR+TPU
047823-NL	TRAKTÖR SERİSİ Tractor Series	ÖN AKS DİFERANSİYEL Front Axle-Differential	HFA100012		12014159		55,00	82,00	-	16,50	-	KOMBI 1X	NBR+TPU
417127	TRAKTÖR SERİSİ Tractor Series	ÖN AKS DİFERANSİYEL Front Axle-Differential	-		12015149		165,00	195,00	-	16,50	18,00	SC6	NBR
415219	TRAKTÖR SERİSİ Tractor Series	ARKA AKS KOVAN Rear Axle	KH3632	71526- 001213211	12016451		140,00	170,00	-	14,50	16,00	SC6	NBR
415219-V	TRAKTÖR SERİSİ Tractor Series	ARKA AKS KOVAN Rear Axle	KH3632		12016688		140,00	170,00	-	14,50	16,00	SC6	FKM
047450	TRAKTÖR SERİSİ Tractor Series	MİL KEÇESİ Shaft Seal	KH1087		12011007	12011008	65,00	85,00	-	10,00	-	L3	NBR
045405	TRAKTÖR SERİSİ Tractor Series	ŞANZİMAN MİLİ Gearbox Shaft	KH1161		12010940		40,00	72,00	-	10,00	-	L3	NBR
047712	TRAKTÖR SERİSİ Tractor Series	ŞANZ. İŞTİRAK DİŞLİSİ Gearbox - Overgear	KH3735	5129003	12011188		55,00	90,00	-	10,00	-	L3L	NBR

SKT NO	KULLANILAN MODELLER Models	KULLANIM YERİ Place Of Use	ORJINAL NO 1 Orijinal No 1	ORJINAL NO 1 Orijinal No 2	EŞDEĞER NO 1 Equivalent No 1	EŞDEĞER NO 1 Equivalent No 2	ÖLÇÜLER MM. Dimensions-MM.					TİP Type	MALZEME Material
415001	D6	KRANK ARKA Crank Shaft Rear	CR 46292		-	-	117,47	152,57	-	15,87	-	SL	NBR
040193	İŞ MAKİNASI Heavy Cons. Equipment	YAĞ POMPASI Oil Pump	7B280		-	-	19,05	35,03	-	10,31	-	SL	NBR
047921	İŞ MAKİNASI Heavy Cons. Equipment	ÖN AKS DİFERANSİYEL Front Axle-Differential	1987825		12018177		62,00	78,00	81,00	10,00	13,80	SPSC	NBR
410047	İŞ MAKİNASI Heavy Cons. Equipment	ARKA AKS Rear Axle	4H-8101	1H-2439	-	-	76,20	101,80	-	11,90	-	SL	NBR
410251	İŞ MAKİNASI Heavy Cons. Equipment	ARKA AKS Rear Axle	3X1660		-	-	88,90	114,45	-	11,11	-	SLL	NBR
415219	İŞ MAKİNASI Heavy Cons. Equipment	ARKA AKS KOVAN Rear Axle	1792801		12016451		140,00	170,00	-	14,50	16,00	SC6	NBR
415219-V	TRAKTÖR SERİSİ Tractor Series	ARKA AKS KOVAN Rear Axle	KH3632		12016688		140,00	170,00	-	14,50	16,00	SC6	FKM
410206	İŞ MAKİNASI Heavy Cons. Equipment	ŞANZİMAN-TORK KONV. Gearbox - Torque Con- vertor	3K9619		-	-	82,55	108,05	-	11,11	-	SLL	NBR
040109	İŞ MAKİNASI Heavy Cons. Equipment	HİDROLİK POMPA Hydraulic Pump	4H1722		-	-	14,28	28,65	-	9,52	-	L3	NBR
045619	955 K,L	HİDROLİK POMPA Hydraulic Pump	2J8169 4K9279	9955110	-	-	36,51	50,90	-	7,93	-	L12L	NBR

SKT NO	KULLANILAN MODELLER Models	KULLANIM YERİ Place Of Use	ORJINAL NO 1 Orijinal No 1	ORJINAL NO 1 Orijinal No 2	EŞDEĞER NO 1 Equivalent No 1	EŞDEĞER NO 1 Equivalent No 2	ÖLÇÜLER MM. Dimensions-MM.					TİP Type	MALZEME Material
412220	D7300 GREYDER	ARKA AKS Rear Axle	12666		-	-	98,43	127,10	-	11,90	-	SLL	NBR
040413	GREYDER D506B-D562D	VİTES SEÇİCİ MİL Gear Selection Shaft	9698		-	-	25,40	44,61	-	6,35	-	L1L	NBR

## EDER

SKT NO	KULLANILAN MODELLER Models	KULLANIM YERİ Place Of Use	ORJINAL NO 1 Orijinal No 1	ORJINAL NO 1 Orijinal No 2	EŞDEĞER NO 1 Equivalent No 1	EŞDEĞER NO 1 Equivalent No 2	ÖLÇÜLER MM. Dimensions-MM.					TİP Type	MALZEME Material
415124	815 EXAVATOR	ARKA AKS Rear Axle	55-6269		-	-	130,00	160,00	-	13,00	14,00	L1L	NBR

## FERMEC/TEREX

SKT NO	KULLANILAN MODELLER Models	KULLANIM YERİ Place Of Use	ORJINAL NO 1 Orijinal No 1	ORJINAL NO 1 Orijinal No 2	EŞDEĞER NO 1 Equivalent No 1	EŞDEĞER NO 1 Equivalent No 2	ÖLÇÜLER MM. Dimensions-MM.					TİP Type	MALZEME Material
047922-VN	TRAKTÖR SERİSİ Tractor Series	ÖN AKS Front Axle	6193363M1		12018849		65,00	92,00	-	10,00	15,00	SC6	FKM+NBR

## KOMATSU

SKT NO	KULLANILAN MODELLER Models	KULLANIM YERİ Place Of Use	ORJINAL NO 1 Orijinal No 1	ORJINAL NO 1 Orijinal No 2	EŞDEĞER NO 1 Equivalent No 1	EŞDEĞER NO 1 Equivalent No 2	ÖLÇÜLER MM. Dimensions-MM.					TİP Type	MALZEME Material
410239	D85A-12	KRANK ARKA Crank Shaft Rear	07012-20080	4K97141	-	-	80,00	105,00	-	13,00	-	L1L	NBR
047619	D155A1	ŞANZİMAN MİLİ Gearbox Shaft	07012-00062		-	-	62,00	85,00	-	12,00	-	L1L	NBR

## LOMBARDINI

SKT NO	KULLANILAN MODELLER Models	KULLANIM YERİ Place Of Use	ORJINAL NO 1 Orijinal No 1	ORJINAL NO 1 Orijinal No 2	EŞDEĞER NO 1 Equivalent No 1	EŞDEĞER NO 1 Equivalent No 2	ÖLÇÜLER MM. Dimensions-MM.					TİP Type	MALZEME Material
046299	KOHLER TİP MOTOR	KRANK MİLİ Crank Shaft	1213257		12000686		37,30	52,00	-	07,00	-	L3L SAÇ	NBR

## MANITOU

SKT NO	KULLANILAN MODELLER Models	KULLANIM YERİ Place Of Use	ORJINAL NO 1 Orijinal No 1	ORJINAL NO 1 Orijinal No 2	EŞDEĞER NO 1 Equivalent No 1	EŞDEĞER NO 1 Equivalent No 2	ÖLÇÜLER MM. Dimensions-MM.					TİP Type	MALZEME Material
417127	YÜKLEYİCİ-İŞ MAKİNASI Loader-Construction Equipment	ÖN AKS DİFERANSİYEL Front Axle-Differential	501058		12015149		165,00	195,00	-	16,50	18,00	SC6	NBR
047700	YÜKLEYİCİ-İŞ MAKİNASI Loader-Construction Equipment	DİFERANSİYEL SİSTEMİ Differential System	549339		12011200	12011017	70,00	100,00	-	10,00	-	L3TL	NBR

SKT NO	KULLANILAN MODELLER Models	KULLANIM YERİ Place Of Use	ORJINAL NO 1 Orijinal No 1	ORJINAL NO 1 Orijinal No 2	EŞDEĞER NO 1 Equivalent No 1	EŞDEĞER NO 1 Equivalent No 2	ÖLÇÜLER MM. Dimensions-MM.					TİP Type	MALZEME Material
046128-NK	YÜKLEYİCİ-İŞ MAKİNASI Loader-Construction Equipment	ÖN AKS Front Axle	040216		12012503		50,00	75,00	-	12,00	-	KOMBI 3	NBR+YÜN
046298-NK	YÜKLEYİCİ-İŞ MAKİNASI Loader-Construction Equipment	ÖN AKS DİFERANSİYEL Front Axle-Differential	044967		12001886		40,00	55,00	-	10,00	-	KOMBI 3	NBR+YÜN
047883	YÜKLEYİCİ-İŞ MAKİNASI Loader-Construction Equipment	DİFERANSİYEL SİSTEMİ Differential System	024937		12011196		65,00	90,00	-	10,00	-	L3L	NBR
047700	YÜKLEYİCİ-İŞ MAKİNASI Loader-Construction Equipment	DİFERANSİYEL SİSTEMİ Differential System	040215		12011200	12011017	70,00	100,00	-	10,00	-	L3TL	NBR
047756	YÜKLEYİCİ-İŞ MAKİNASI Loader-Construction Equipment	DİFERANSİYEL SİSTEMİ Differential System	027447		12011201		75,00	95,00	-	10,00	-	L13TL SS-RL	NBR
045948	YÜKLEYİCİ-İŞ MAKİNASI Loader-Construction Equipment	ŞANZ. KAVRAMA MİLİ Gearbox - Coupling Shaft	006467AA		12011147		35,00	62,00	-	7,00	-	L3TL	NBR

**PANCAR MOTOR**

SKT NO	KULLANILAN MODELLER Models	KULLANIM YERİ Place Of Use	ORJINAL NO 1 Orijinal No 1	ORJINAL NO 1 Orijinal No 2	EŞDEĞER NO 1 Equivalent No 1	EŞDEĞER NO 1 Equivalent No 2	ÖLÇÜLER MM. Dimensions-MM.					TİP Type	MALZEME Material
4TM-020	E-89 TİP MOTOR	MOTOR LASTİK TM. TK. Engine Repair Kit	E89		-	-	-	-	-	-	-	TM	-
4TM-028	E-89 TİP MOTOR	MOTOR KEÇELİ TM.TK. Engine Seal Repair Kit			-	-	-	-	-	-	-	TM	-
4TM-029	E-108 TİP MOTOR	MOTOR KEÇELİ TM.TK. Engine Seal Repair Kit			-	-	-	-	-	-	-	TM	-
4TM-030	Z-108 TİP MOTOR	MOTOR KEÇELİ TM.TK. Engine Seal Repair Kit			-	-	-	-	-	-	-	TM	-
047473-S	D108-V108	KRANK ÖN Crank Shaft Front	40034700-989		-	-	70,00	85,00	-	8,00	9,00	L1L	VMQ
047470-S	E 108-Z108-D108-V108	KRANK ÖN Crank Shaft Front	40034900-989		-	-	82,00	100,00	-	13,00	-	L1 SAĞ -Right	VMQ
047772-V	DİZEL MOT. Diesel Motor	KRANK MİLİ Crank Shaft			-	-	70,00	85,00	-	8,00	9,00	L3L SOL -Left	FKM
410242-S	E108-Z108-D108-V108	KRANK ARKA Crank Shaft Rear	40055300989		-	-	90,00	110,00	-	15,00	12,50	LL3T SOL -Left	VMQ
4S-003-V	E-180 / V-108	SUPAP Valve Stem Seal			-	-	9,00	12,00	15,00	6,50	11,00	LSY3	FKM

## SHIBAURA

SKT NO	KULLANILAN MODELLER Models	KULLANIM YERİ Place Of Use	ORJINAL NO 1 Original No 1	ORJINAL NO 1 Original No 2	EŞDEĞER NO 1 Equivalent No 1	EŞDEĞER NO 1 Equivalent No 2	ÖLÇÜLER MM. Dimensions-MM.					TİP Type	MALZEME Material
045664-P	SD 4000 A	KRANK ARKA Crank Shaft Rear	198636050	83920450- 83921125	-	-	50,00	72,00	-	12,00	-	L3L SOL -Left	ACM
045664-S	SD 4000 A	KRANK ARKA Crank Shaft Rear	198636050		-	-	50,00	72,00	-	12,00	-	L3L SOL -Left	VMQ
45-004-V	SD 4000 A	SUPAP Valve Stem Seal	120406040		-	-	8,00	13,00	17,00	9,00	12,80	LSY	FKM
040256	SD 4000 A	DİF.ÖN-MAHRUTİ Differential Front	050102230		12010881	-	30,00	45,00	-	8,00	-	L3	NBR
040256	SD 4000A-AO	DİF.ÖN-MAHRUTİ Differential Front	245-1005034	SD4000A-AO	12010881		30,00	45,00	-	8,00	-	L3	NBR

## SÜPER STAR

104

SKT NO	KULLANILAN MODELLER Models	KULLANIM YERİ Place Of Use	ORJINAL NO 1 Original No 1	ORJINAL NO 1 Original No 2	EŞDEĞER NO 1 Equivalent No 1	EŞDEĞER NO 1 Equivalent No 2	ÖLÇÜLER MM. Dimensions-MM.					TİP Type	MALZEME Material
045347	BT-30	ARKA AKS Rear Axle	-		-	-	38,00	62,00	-	10,00	-	L3	NBR
040169	BT-30	ŞANZİMAN ÖN Gearbox Front	-		-	-	30,00	45,00	-	10,00	-	L3	NBR



SKT NO	KULLANILAN MODELLER Models	KULLANIM YERİ Place Of Use	ORJINAL NO 1 Orijinal No 1	ORJINAL NO 1 Orijinal No 2	EŞDEĞER NO 1 Equivalent No 1	EŞDEĞER NO 1 Equivalent No 2	ÖLÇÜLER MM. Dimensions-MM.					TİP Type	MALZEME Material
0412313	U 445	ARKA AKS DIŞ Rear Axle Outer	3079502190 CS		-	-	110,00	130,00	-	13,00	-	SLL	NBR
412313-V	U 445	ARKA AKS DIŞ Rear Axle Outer	-		-	-	110,00	130,00	-	13,00	-	SLL	FKM
045213	U 445	DİF.ÖN-MAHRUTİ Differential Front	-		-	-	35,00	55,00	-	12,00	-	L3	NBR

SKT NO	KULLANILAN MODELLER Models	KULLANIM YERİ Place Of Use	ORJINAL NO 1 Orijinal No 1	ORJINAL NO 1 Orijinal No 2	EŞDEĞER NO 1 Equivalent No 1	EŞDEĞER NO 1 Equivalent No 2	ÖLÇÜLER MM. Dimensions-MM.					TİP Type	MALZEME Material
417132	TRAKTÖR SERİSİ Tractor Series	ÖN AKS Front Axle	930874 1349265C1	9968085 47108806	12013126		150,00	176,00	-	15,50	16,00	SC6	NBR
041331-NK	TRAKTÖR SERİSİ Tractor Series	ÖN AKS DİFERANSİYEL Front Axle-Differential	930126		12001879		30,00	44,00	-	11,00	-	KOMBI 3	NBR+YÜN
046300-NK	TRAKTÖR SERİSİ Tractor Series	ÖN AKS DİFERANSİYEL Front Axle-Differential	930148		12011969		45,00	65,00	-	12,00	-	KOMBI 3	NBR+YÜN
415220	TRAKTÖR SERİSİ Tractor Series	ÖN AKS DİFERANSİYEL Front Axle-Differential	930232	Y00796	12016448		130,00	160,00	-	14,50	16,00	SC6	NBR
040765	TRAKTÖR SERİSİ Tractor Series	ŞANZİMAN MİLİ Gearbox Shaft	974201	6077570	12011131		30,00	40,00	-	7,00	-	L3L	NBR







SKT Yedek Parça ve Makina Sanayi ve Ticaret A.Ş.  
BOSB, Ali Osman Sönmez Bulvarı No: 17 16140 Nilüfer/Bursa-TÜRKİYE  
T:+9 0 224 243 41 00 [info@skt.com.tr](mailto:info@skt.com.tr)

